

# HAGER & WERKEN

Innovation for Perfection



# No. 20



THE  
BAMBACH  
SADDLE  
SEAT™



hf Surg®



Mira-2-Ton®



LaserHF®

Miraject®

 miradent  
oral care system

OXYSAFE™  
TWINSAFE

# Our team worldwide



Patrick Hager,  
President

Michael Hager,  
Senior Adviser



Our international team



Hager & Werken GmbH & Co. KG  
Ackerstraße 1, 47269 Duisburg,  
Germany  
Tel.: +49 (203) 99269-0  
Fax: +49 (203) 299283  
E-Mail: info@hagerwerken.de  
Website: www.hagerwerken.de  
General Manager: Patrick Hager



HAGER & WERKEN (ASIA) CO. LTD.  
Unit 02, 8/F, Block B, New Trade Plaza,  
6 On Ping Street, Sha Tin, N.T.  
HONG KONG  
Tel.: +852-2622 2795/2622 2796  
Fax: +852-2622 2503  
E-Mail: kate@hagerasia.com.hk  
General Manager: Kate Tsui



Hager Worldwide, Inc.  
441 19TH Street SE  
Hickory N.C. 28602, USA  
Tel.: +001 (828) 624-3300  
Fax: +001 (828) 624-3303  
E-Mail: contact@hagerworldwide.com  
Website: www.hagerworldwide.com  
General Manager: Mark Schneider



HAGER EURASIA TOO  
„Dostyk Residence“  
Mitina str. 4, of. 906, Almaty, Kazakhstan  
Tel.: +7 771 713 7758  
E-Mail: o.seifert@hagerwerken.de  
General Manager: Olga Seifert



Hager Polonia Sp. z o.o.  
Ul. Galczyńskiego 23  
52-214 Wrocław  
Tel.: +48 - 71-368-71-66  
Fax: +48 - 71-368-10-21  
E-Mail: biuro@hager.com.pl  
General Manager: Ania Biernacka-Świenc



HAGER PHARMA GmbH  
Ackerstraße 1, 47269 Duisburg, Germany  
Tel.: +49 (203) 99 269 900  
Fax: +49 (203) 99 269 999  
E-Mail: info@hager-pharma.de  
Website: www.hager-pharma.de  
General Manager: Klemens Böhm



HBI Health & Beauty International GmbH  
Widdersche Str. 58, 47804 Krefeld  
Tel.: +49 (2151) 1502140  
Fax: +49 (3222) 1606900  
E-Mail: info@health-beauty-international.com  
Website: www.health-beauty-international.com  
General Manager: Marco Quast

## Always close to our customers

Hager & Werken and its brand miradent have been well-known to dentists, dental technicians and dental professional personnel for more than 75 years. The product catalogue has long been used and kept as a compendium for innovative product specialties. Since 2000 it has also been available online at [www.hagerwerken.de](http://www.hagerwerken.de).

Our products are constantly checked and new products are only introduced to our range if they offer a clear advantage to available alternatives – true to the motto “always one step ahead!”. A new product needs to be quicker and more practical in use and should at best also offer a higher patient comfort.

Hager & Werken offers its products on 6 continents and it is due to our promise of quality that we were able to acquire many new satisfied regular customers over the last two decades. Not only is this promise of quality being attested by annual TUV audits in accordance with ISO 13458, but this concept is also incorporated in our company. Many customers compliment us on our pursuit of quality with our own products. Being a family-run business, we put particular emphasis on employee training. About 25 % of our staff consist of our former trainees, resulting in the personal engagement and professional competence we value in each and every employee. In the end, it is the customer who benefits from it.

We should be grateful for your continued confidence in us in the future and look forward to enriching your everyday work with our innovative products. Your satisfaction is of the utmost importance to us. Please get into direct contact with us for any question, suggestion and criticism – we look forward to hearing from you!

*Patrick Hager*

## Our team – always ready for our customers!

For questions and orders please contact our sales representatives, our sales team in Duisburg or your dental dealer. Detailed and up-to-date information about our products can be found on the Internet at:

[www.hagerwerken.de](http://www.hagerwerken.de) and [www.miradent.de](http://www.miradent.de)



### Our team in Duisburg is available:

**Mon. – Thu. 08:00 – 17:00**

**Fri. 08:00 – 15:30**

**Fon: +49 (203) 99 269 + extension number**

**Fax: +49 (203) 299283**

#### Service Export

Anneli Heyse, [a.heyse@hagerwerken.de](mailto:a.heyse@hagerwerken.de)

- 43

Florentine Bartels, [f.bartels@hagerwerken.de](mailto:f.bartels@hagerwerken.de)

- 45

Dirk Seelbach, [d.seelbach@hagerwerken.de](mailto:d.seelbach@hagerwerken.de)

- 47

#### Technical Service

[technischer-service@hagerwerken.de](mailto:technischer-service@hagerwerken.de)

- 61

#### European Sales and Marketing Director

Marcus van Dijk, [m.vandijk@hagerwerken.de](mailto:m.vandijk@hagerwerken.de)

- 16

#### European Sales Manager

Jörg Zensen, [j.zensen@hagerwerken.de](mailto:j.zensen@hagerwerken.de)

+49 (172) 210 72 03

#### Sales Manager Austria/Switzerland

Simone Krug-Trummer, [s.krug@hagerwerken.de](mailto:s.krug@hagerwerken.de)

+43 (664) 150 1417

#### Sales Manager France/Spain/Portugal

Séverine Sánchez, [s.sanchez@hagerwerken.de](mailto:s.sanchez@hagerwerken.de)

+34 (687) 381 020

#### Sales Manager Adriatic Region

Klaudija Primorac, [klaudija@hagerwerken.de](mailto:klaudija@hagerwerken.de)

+385 (98) 997 4678



German headquarters



Hager Worldwide Corporate Office Hickory, North Carolina



Hager Polonia Corporate Office Wrocław (Breslau), Poland

# Index Chapter

## 06 BIOLine

More and more practices are considering sustainable products to be an important environmental contribution. With our new BIOLine series, we now offer dental sustainable alternatives. All BIOLine products are compostable, biodegradable or made of recycled material.

## 09 Application/Injection

Miraject, THE No.1 – over 400 million pain-free injections stand for safety and satisfied patients. Our blunt application cannulas also guarantee the highest quality.

## 16 Impression

A new impression tray with foil technology for implantology has been developed at the University of Aachen in Germany. The invention: Implant posts „pierce“ the foil, allowing fast, easy, clean and precise positioning. The method reduces the time and laboratory costs and saves the patient a second session.

## 20 Dental Specialties

Wide range of innovative products such as Reso-Pac, a „self-dissolving plaster‘ in the mouth,“ GapSeal THE prevention against Periimplantitis, Mirahold bite blocks to hold mouths open and many more ...

## 40 Rubberdam

Quality without compromise – permanently consistent clamping force. Our stainless steel clamps are adjusted to the intended tooth precisely, accurately and expediently at the manufacturing plant.

## 47 Fillings/Endodontics

Many little helpers save the dentist time while offering additional patient comfort, e.g. our fissure printer for composite fillings, our atraumatic Crown-Click or N2 root canal cement for difficult cases.

## 50 Protection and Hygiene

As a market leader for dental eye protection, we not only emphasize on safety but also on comfort and stylish designs. In addition to our iSpec series we offer face shields and economically priced H&W protective eyewear.

## 60 Patient Service and Motivation

Our study models educate patients and raise awareness of high quality prosthetic restorations. Additionally we feature a wide range of toys to reward brave, young patients.

## 68 Devices

For over 30 years we have been a reliable partner for modern radio-frequency surgery units. Our LaserHF offers the perfect combination of Laser and RF technology.

## 79 Bambach®

Our saddle seats have often been imitated, but never equaled. Worldwide more than 50,000 seats relieve back tensions in dental practices. We would be more than happy to visit your practice for a free demonstration.

## 84 miradent®

Our prophylaxis home care assortment: A full range from infant to senior care products. In our campaign „Chew against Plaque“ we educate about the benefits of Xylitol e.g. anti-cariogenic effects.

## 100 Lab Products and Small Equipment

For (in-office) labs we offer small devices and consumables. Highly appreciated best sellers are: Occlu Spray, Mirawet mixing liquid, our light curing Speed Labolight and our portable Micromotor Bravo Portable.

## Index Products

Airsonic Absorbo Box	75	Bambach Foot Height Adjuster	82	Compo Blitz Polisher	21	Fit Rubberdam Clamps	46
Airsonic Adapters	75	Bambach Leather Care Oil	82	Corund SC	102	Fit Rubberdam Clamps Black	43
Airsonic Alu-Oxyd	75	Bambach OP	82	Cotton-Clip	29	Fit Rubberdam	
Airsonic Mini Sandblaster	75	<b>Bambach Seat Cover</b>	<b>82</b>	Cottoroll	29	Clamps for Children	44
Algilock	18	BD-Steribox	28	Crown Click De Luxe	27	Fit Rubberdam Folding Frame	42
Algilock Cleaner Plus	19	<b>Bio Apply-Tips</b>	<b>7</b>	Cup Dispenser	8	Fit Rubberdam-Latex	41
Algilock Partiiell	19	<b>Bio Bowl</b>	<b>8</b>	Cyano Fast	21	Fit Rubberdam Perforating	
Algilock Pedo	19	<b>Bio Cup</b>	<b>8</b>	Cyano Pipettes	21	Template	40
Algilock Perforiert	18	<b>Bio Dapp</b>	<b>7</b>			Fit Rubberdam Punch	41
Algiloid	19	<b>Bio Dento-Box</b>	<b>6</b>	Dapp-a-Way	36	Fit Rubberdam Starter Kit I	40
Algimix	72	<b>Bio Mix Mixing Pad</b>	<b>6</b>	Del-Ject	33	Fit Rubberdam Starter Kit II	40
Alminax	102	<b>Bio Mouse and Bio Keyboard</b>	<b>7</b>	<b>Dentemp Crown &amp; Caps</b>	<b>105</b>	Fit Rubberdam Steel Frame	42
Alminax Rite-Bite	102	<b>Bio Towel</b>	<b>8</b>	<b>Dentemp Reline it</b>	<b>105</b>	Fit Rubberdam study booklet	42
Amalgam Well	33	<b>Bio Trays</b>	<b>6</b>	<b>Dentemp Repair it</b>	<b>105</b>	Fit Rubberdam T-Clamps	44
Anti-Stress Tooth	67	<b>Bio Xray</b>	<b>7</b>	Dento-Box I	98	Fit-N-Fix	29
Apply-Tips	14	Blue-Flame 1500	76	Dento-Box I + II	62	<b>Fit-N-Swipe</b>	<b>20</b>
APT Gas	77	Bravo Portable II	73	Dipol	101	<b>Fit-N-Swipe Clean</b>	<b>20</b>
APT III Burner	76	<b>Bravo Portable II Plus</b>	<b>73</b>	Dosing Bottle	28	<b>Fit-N-Swipe Dry</b>	<b>20</b>
AQUAMED Chewing Gum	86	Brillant	24	Durotanic Mouth Mirror	24	Flexbrush	23
AQUAMED Lozenges	86	Brillant Anti-Fog	24			Flex-O-Bol	100
AQUAMED Spray	86			Emmenix Film Holder	23	Funny Animals	99
Artiholder	27	Calci-Line	48	Emmenix Flap	22		
Astro Clean	57	Carebrush ortho	87	Endo N2	47	GapSeal	9
		Carebrush supersoft	87			Glas Bead Heater	74
<b>Bambach</b>	79 – 83	Carebrush white	87	Fit Rubberdam		Gripit	27
Bambach Armrest	83	CC-Schild	50	Cervical Clamp 214	43		
<b>Bambach Armrest</b>		Chiru-Cleaner	31	Fit Rubberdam Clamp Board	40	<b>Hager iSpec anti-stress</b>	<b>53</b>
<b>Microscope</b>	<b>83</b>	Chirurgo-Suc I	31	Fit Rubberdam Clamp Forceps	41	Hager iSpec BT Fit	54
<b>Bambach Armrest Smart</b>	<b>83</b>	Clip-Clap	28	Fit Rubberdam Clamps	45	<b>Hager iSpec</b>	
<b>Bambach Backrest Smart</b>	<b>83</b>	Cold-Bag	32	Fit Rubberdam Clamps	45	<b>cleaning wipes</b>	<b>57</b>

Hager iSpec Comfort Fit	53	McTooth Mirror	61	Non-Stick	102	XyliPOP	85
Hager iSpec Fit OTG	54	Membranbox Medium	62	<b>Occlu Spray Plus</b>	33 + 103	Xylitol Chewing Gum	84
Hager iSpec Flexi Fit	55	Membranbox		Orange Solvent	32	Xylitol Drops	86
Hager iSpec Flexi Fit II	55	Small and XXL	62	Orbatec	104	Xylitol Powder	85
<b>Hager iSpec Full-vision safety glasses</b>	<b>51</b>	Micro-Etch	48	Orbatec Prophy	104	<b>Zahnpick</b>	<b>93</b>
<b>Hager iSpec Lux</b>	<b>51</b>	Mira-2-Ton	38 + 96	<b>OXYSAFE Active<sup>+</sup></b>	<b>92</b>		
Hager iSpec Pure Fit	53	Mira-2-Ton Solution	38 + 96	OXYSAFE Gel and Liquid Professional	34		
Hager iSpec Safety Fit	52	<b>Mira-2-Ton Pellets</b>	<b>38</b>	<b>Parallelometer-Mirror</b>	25		
Hager iSpec Safety Fit II	52	Mira-2-Ton Tablets	38 + 96	paroguard	38 + 89		
Hager iSpec Slim Fit UV	54	Mirabol	100	Pelotte-Aspirator	30		
<b>Hager iSpec Smart</b>	<b>51</b>	Mirabrush	14	Pelotte Plus	30		
Hager iSpec Softflex Fit	52	Miracast	77 + 104	Pic-Brush Intro Kit	94		
Hager iSpec Steril Fit OTG	54	Mira Clean	35	Pic-Brush Replacement Brushes	94		
<b>Hager iSpec</b>		Miraclean-Implant Black	47	Pic-Brush Set	94		
<b>Sunshine Fit 2.0</b>	<b>52</b>	Mira-Clin hap	36	Pick up Stick	14		
Hager iSpec Super Lite Fit	55	Mira-Clin Implant	92	Plaque Agent	99		
Hager iSpec X Fit	55	Mira-Clin P	36	Plaque Check	96		
Hager iSpec Laser		Miraclip	29	Praxipolish Plus	32		
safety glasses	69	Miracold Plus	32	Praxipol PS II	72		
Hager Outbacks	58	miradent Hourglass	98	Prophy-Angles	39		
halitosis spray	96	miradent Mouth Mirror	95	<b>Prophy-Brush</b>	<b>39</b>		
Happy Morning	37 + 88	Miradont-Gel	15	Prophy-Cup	39		
<b>Happy Morning Bamboo</b>	<b>6 + 88</b>	Mira-Duo	61	Prophy-Ring	36		
Happy Morning De Luxe	87	Mirafloss	93	Protectoray	23		
Happy Morning Travel Kit	88	Mirafloss Big	35 + 92	Protho Box	97		
Happy Morning Xylitol	88	Mirafluor C	90	Protho Brush De Luxe	97		
hf1 Surg bipolar	70	mirafleur chx	89	Protho Clean	33 + 104		
hf Bipolar-Forceps	71	mirafleur-gel	37	Proto-Cam	50		
hf Electrodes	71	<b>Mirafluor Kids</b>	<b>90</b>	<b>Proto-Cam Smart</b>	<b>50</b>		
hf Neutral Electrode	71	Mirafluor-Tray	37	Putzi-Buddys	63		
hf Surg	70	Mirafluorid	37	Putzi-Pets	63		
H&W Classic	56	Mirahold	26	<b>Reflect-Rhod</b>	25		
H&W Featherlight	56	Mirahold-Block	26	Reso-Pac	15		
H&W Kids Protect	58	Miraject	12	Röntgomarker	22		
H&W OTG II	57	Miraject Endo Luer	11	Rotoprox	39		
H&W Panorama	56	Miraject Endotec Duo	12	<b>Salibag</b>	22		
H&W Panorama II	57	Miraject Endotec Luer	11	SOS Zahnbox	89		
H&W Super Fit UV (OTG)	56	Miraject Flexi Tip	13	Spandex	26		
		Miraject Luer	12	Spandex-Vertical	26		
		Miraject PL Super	11	Speed Labolight	74		
<b>Infant-O-Brush</b>	98	Miraject P/P Super	11	Speedo-Clean	73		
Integra Cart De Luxe II	78	Miraject P/P Super	11	Steri-Suc-Tube	31		
Integra Cart Fit-On Tray	78	Miramask	59	Study Model			
Integra Cart Smart	78	<b>Miramask FFP2</b>	<b>59</b>	Demo Implant C+B	60		
I-Prox Care Set	95	<b>Miramask FFP3</b>	<b>59</b>	Study Model Transparent	61		
I-Prox L	93	Miramatic-Box	13	Study Model Transparent Child	60		
I-Prox P	95	Miramatic Holder	13	Study Model Transparent			
		Miramatic Holder Plus	13	De Luxe	61		
		Mirapont	100	Study Model Transparent Plus	61		
<b>Kid's Brush</b>	99	Mirapont Agent Plus	100	Super-Splint	48		
Kisag Burner	76	Mirapont Silifit	100	Super-Splint De Luxe	48		
		Mirapor	101	<b>Tong-Clin De Luxe</b>	97		
<b>LaserDUO</b>	69	Mirapost	49	Tong-Clin Gel	97		
LaserHF	68	mirasensitive hap <sup>+</sup>	90	Toothbrushing Model	60		
LaserHF Curver/		Mirasuc Adapter	30	Tooth Coin Bank	67		
LaserHF Fiber Cutter	71	Mirasuc Brush	31	Twin-Pipette	14		
LaserHF PDT Solutions	69	Mirasuccto	30	<b>Variator-Kit</b>	24		
Liftbox	25	<b>Mirati (NEW No. 21 + 22)</b>	<b>63 – 67</b>	Vernax 100	103		
		Mirator 2000E	72	Vernax Collodial Graphite	103		
<b>Mara Expert</b>		Miratorch	77	Vernax S/Vernax G	103		
Charcoal Intensive	107	Miratrax	17	Vernax Thinner	103		
Mara Expert		Miratrax 3 in 1	16	<b>XYLIMED Nasal spray and drops</b>	<b>91</b>		
Charcoal Plus Sensitive	107	Miratrax Implant	16				
<b>Mara Expert ecosmile</b>	<b>107</b>	Miratrax-Mini	17				
Mara Expert		Miratrax-Partial	17				
Floss sticks	106	Miratrax Spray	18				
Mara Expert Interdental brushes „basic“	106	Mirawet	101				
Mara Expert Interdental Brushes		Mirawhite gelée	91				
“Premium Line“	106	Mirawhite Laser Bleaching	69				
Matrix-Spanner	21	Mirawhite shine	91				
		Mirodent	24				
		Myzotect-Tincture	35				

**New products are marked in bold!**



### Scan QR code

1. Open the built-in camera of your cell phone and point the camera at the QR code you want to scan for 2 – 3 seconds.
2. A notification message will pop up if the scanning function is activated.
3. Should nothing happen, you need to enable QR code scanning in the settings first.

# BIOLine



With xylitol



Ready to use



Eco-Friendly



More and more practices are considering sustainable products to be an important environmental contribution. With our new BIOLine series, we now offer dental sustainable alternatives.

All BIOLine products are compostable, biodegradable or made of recycled material.

## Happy Morning® Bamboo

### Disposable toothbrush made of bamboo

- Handle made from 100 % biodegradable, sustainably grown bamboo
- Bamboo acts antibacterial and germ-reducing
- Bristles are impregnated with xylitol toothpaste
- Short head design (2.5cm)
- Individually, hygienically packed in biodegradable film

Article	Content	REF
Happy Morning Bamboo	40 pcs.	605 426

Bio Dento-Box I:  
height 3 cm



Bio Dento-Box II:  
height 4 cm

## Bio Dento-Box®

### Solid transport and storage box

- Made of bio-plastic (Terralene 75 %, 25 % Mineral Material)
- For prosthesis, orthodontic works, etc.
- Impact-proof, safe snap lock and small ventilation holes
- Biodegradable

Article	Content	REF
Bio Dento-Box I	12 pcs.	640 020
Bio Dento-Box II	10 pcs.	640 030



W x H x D: 28 x 18 x 1.5 cm

## Bio Trays

### Disposable trays for dental instruments

- PLA: Polymer of plant origin (derived from corn starch)
- Highly stable product
- Transparent coloring
- Compostable

Article	Content	REF
Bio Trays	100 pcs.	640 010



Size: 7 x 8 cm

## Bio Mix Mixing Pad

### Disposable mixing pads

- Made of bioplastics (made of 75 % Terralene® and 25 % mineral charge)
- For impression materials, cements, composites etc.
- Made of paper in combination with Biocartene (bio-based plastic)
- Consisting of 100 sheets, each 0.10 mm thick
- Non-slip base with special plastic-free coating
- Biodegradable

Article	Content	REF
Bio Mix Mixing Pad	6 x 100 sheets	640 011

## Bio Apply-Tips®

### For precise application of liquids and pastes

- Made partially from wheat straw
- For precise application of liquids and pastes
- Bendable ends for areas that are difficult to access
- Economical use of expensive materials (such as bonding, medication, etc.)
- Acid resistant to bonds and other materials
- Hygienic dispenser pack for individual use
- Available in three sizes
- Biodegradable

Article	Content	REF
Bio Apply-Tips, super fine, 1.5 mm	100 pcs.	640 050
Bio Apply-Tips, fine, 1.9 mm	100 pcs.	640 051
Bio Apply-Tips, regular, 3.0 mm	100 pcs.	640 052



## Bio Mouse and Bio Keyboard

### Hygienic sleeves for PC mouse\* / PC keyboard

- Soft and flexible material
- Easy and quick handling
- Biodegradable

Article	Content	REF
Bio Mouse (small)	500 pcs.	640 060
Bio Mouse (large)	500 pcs.	640 061
Bio Keyboard (small)	500 pcs.	640 065
Bio Keyboard (large)	250 pcs.	640 066

\* Universal size, fit both cordless and corded optical mouse devices

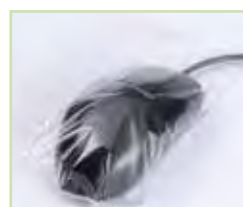

Size:  
small 150 x 85 mm  
large 160 x 100 mm

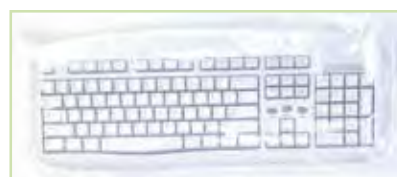

Size:  
small 160 x 550 mm  
large 215 x 550 mm

## Bio Dapp

### Disposable Dappen

- Made of bioplastic (Terralene 75 %, 25 % Mineral Material)
- To mix and prepare dental materials
- Notch to fix on the tray
- Capacity: approx. 2 – 3 ml
- Biodegradable

Article	Content	REF
Bio Dapp	200 pcs.	640 015



## Bio Xray

### Hygienic sleeves for x-ray cameras

- Sleeve holds position until removed
- Easy handling
- Biodegradable

Article	Content	REF
Bio Xray	250 pcs.	640 075



Size:  
350 x 240 x 750 mm



Size: 100 x 280 mm

## Bio Cup

### Disposable mouth rinse cups

- Made from FSC certified paper
- Leak proof due to PLA coating
- Dispenses easily from cup dispenser due to their rolled lip
- Capacity: 180 ml (6 Oz)
- Compostable

Article	Content	REF
Bio Cup	1000 pcs.	640 000

## Cup Dispenser

### Adjustable cup dispenser made of ABS plastic

- Self-adhesive
- Capacity about 50 cups
- Adjustable to 150 ml – 200 ml cups

Article	Content	REF
Cup Dispenser	1 pcs.	640 007



## Bio Bowl

### Kidney trays made from recycled paper

- For storage after treatment
- Compostable

Article	Content	REF
Bio Bowl	50 pcs.	640 040

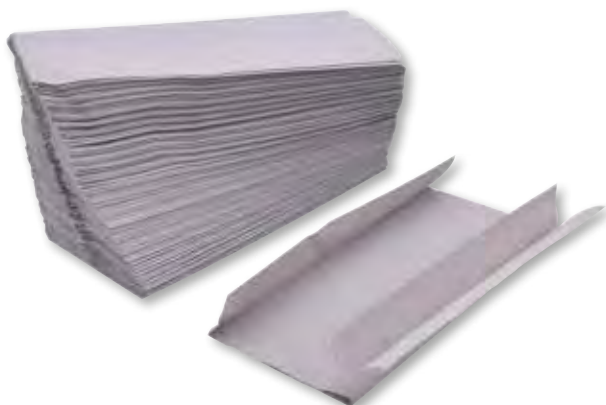

## Bio Towel

### Recycled paper napkins

- Natural gray, without dyes
- 1-ply, C-fold
- 40 gr/m<sup>2</sup>
- Compostable

Article	Content	REF
Bio Towel	3000 pcs.	640 013



# GapSeal®

## The decisive weapon against peri-implantitis

- Seals implant gaps and hollow spaces
- Durably stops infiltration of germs into the hollow spaces
- Eliminating risk of re-infection of peri-implant tissue
- Effectively avoids a main reason for peri-implantitis
- Successful over 20-year clinical study of the University Düsseldorf, Germany
- Quick and easy handling and application

Article description	REF
GapSeal Set (applicator with 10 Tips)	152 041
GapSeal Refill Pack (10 Tips à 0,06 ml)	152 040
GapSeal Applicator separately	152 042

### Gap Sealing against Peri-implantitis

Out of manufacturing constraints, gaps and hollow spaces between implant and superstructures are inevitable in all compound implants. These gaps can be minimized depending on fabrication precision. However, they are never completely bacteria-proof and in an open connection with the bacteria-, fungi- and virus settled oral cavity. The spectrum of germs settling in the hollow spaces consists of a large quantity of gram-negative, mostly anaerobic bacteria, as it is the case with peri-implantitis. These humid and warm implant interiors offer an ideal milieu for the growth of bacteria and partly also cause fungi and virus affection. Already 20 years ago, at the Clinic for Oral and Maxillofacial Surgery of the Heinrich-Heine University, Düsseldorf, Germany under the direction of Prof. Dr. Dr. Fritzemeier it was begun to find a solution to this problem. The gap between abutment and implant averages „only“ 45 microns, whereas most of the relevant germs have a size of between 0.5 microns and 4 microns. Based on extensive studies and tests, a material was developed sealing all capillary gaps and interior spaces of the compound implant bacteria-proof.

GapSeal is based on a special silicone matrix ingredient composition, which creates a barrier effectively preventing infiltration and colonization by bacteria. It is used immediately after inserting the implant with the first fixing of the locking screw. Therefore, the implant is durably protected against colonization by bacteria, viruses and fungi from the very beginning. GapSeal is most easy in application as the material is offered in small portion carpules, together with a special applicator.

GapSeal seals the gaps and hollow spaces, which are to be found in every compound implant, thus effectively and durably avoiding colonization of germs into these hollow spaces and eliminating the risk of re-infection/microleakage of the peri-implant tissue, one of the main reasons for peri-implantitis.

### Properties of GapSeal:

- Lasting, hermetic protection, no formation of micro-gaps
- Prevents micro leakage
- Ideal for assembled implants
- Gentle to the tissue
- Highly viscous, transparent material (silicone matrix)

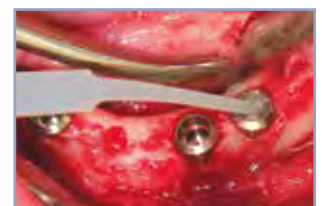
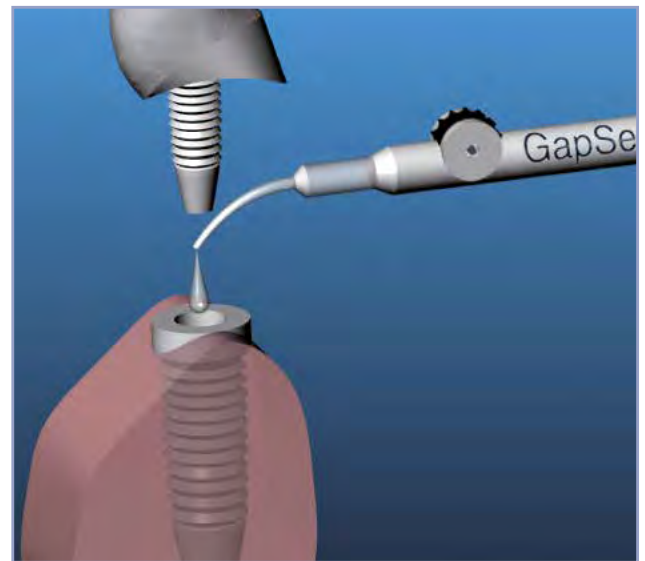









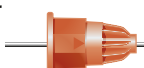

After removal of the closure cap, GapSeal can directly be applied by simply turning the transport screw.











Immediately after the application, the implants are generously loaded with GapSeal. The implant gets sealed airtight with GapSeal, leaving no hollow spaces, by inserting the locking screw.

• APPLICATION •

 Standard

<b>Miraject P (Carpule)</b> REF 254 206		0.8 x 25 mm/21G	
<b>Miraject P Super (Carpule)</b> REF 254 207		0.9 x 32 mm/20G	
<b>Miraject PL Super (Luer)</b> REF 254 214		0.9 x 22 mm/20G	
<b>Miraject Endo Luer</b> REF 254 222		0.3 x 40 mm/30G	
<b>Miraject Endo Luer</b> REF 254 215		0.5 x 40 mm/25G	

 Endotec Luer













<b>Miraject Endotec Luer</b> REF 254 216		0.8 x 25 mm/21G	
<b>Miraject Endotec Luer</b> REF 254 217		0.6 x 25 mm/23G	
<b>Miraject Endotec Luer</b> REF 254 218		0.5 x 25 mm/25G	
<b>Miraject Endotec Luer</b> REF 254 228		0.4 x 25 mm/27G	
<b>Miraject Endotec Luer</b> REF 254 219		0.3 x 25 mm/30G	

 Endotec Luer Duo







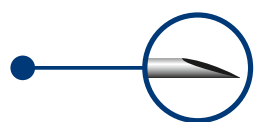

<b>Miraject Endotec Duo</b> REF 254 230		0.6 x 25 mm/23G		<b>Miraject Endotec Duo</b> REF 254 232		0.4 x 25 mm/27G	
<b>Miraject Endotec Duo</b> REF 254 231		0.5 x 25 mm/25G		<b>Miraject Endotec Duo</b> REF 254 233		0.3 x 25 mm/30G	

• INJECTION •

 Carpule

<b>Miraject 17/42</b> REF 254 200		0.5 x 35 mm	
<b>Miraject 17/23</b> REF 254 201		0.5 x 21 mm	
<b>Miraject 30/42</b> REF 254 202		0.4 x 35 mm	
<b>Miraject 30/23</b> REF 254 203		0.4 x 21 mm	
<b>Miraject 40/23</b> REF 254 204		0.3 x 21 mm	
<b>Miraject 40/10</b> REF 254 205		0.3 x 10 mm	

 Luer

<b>Miraject Luer 17/42</b> REF 254 210		0.5 x 42 mm	
<b>Miraject Luer 17/23</b> REF 254 211		0.5 x 23 mm	
<b>Miraject Luer 30/42</b> REF 254 212		0.4 x 42 mm	
<b>Miraject Luer 30/23</b> REF 254 213		0.4 x 23 mm	

**60 years**  
of highest quality

## Miraject® P/P Super

### Canula for paste-like materials

- Blunt, bendable and individually sterile packed
- For cylinder ampoules
- Color-coded

#### Pack with 100 pieces

Article	∅	Gauge	Length	REF
Miraject P	0.8 mm	21	25 mm	254 206
Miraject P Super	0.9 mm	20	32 mm	254 207

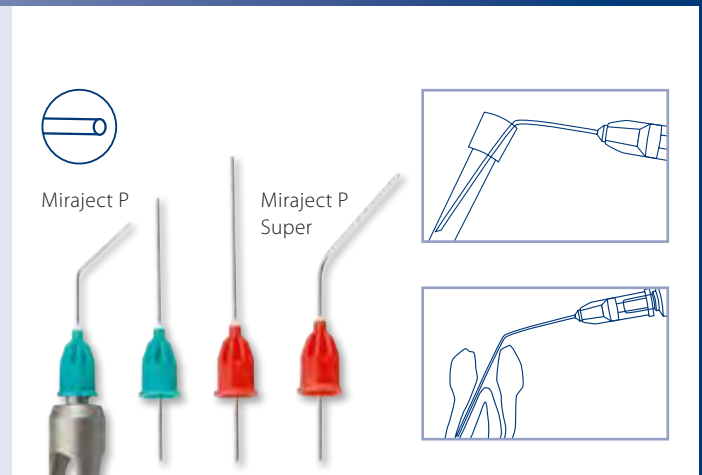

## Miraject® PL Super

### Short blunt Luer application canula

- For application of liquids, gels and for rinsing wider root canals
- Sterile packed
- Bendable
- For syringes with Luer tip

#### Pack with 100 pieces

Article	∅	Gauge	Length	REF
Miraject PL Super	0.9 mm	20	22 mm	254 214



## Miraject® Endo Luer

### Long blunt Luer application canula

- Application of liquids and pastes into the root canal
- Finest controllable measures
- In two sizes: 0.3 mm (30 gauge) and 0.5 mm (25 gauge), easy-to-insert into the root canal
- For syringes with Luer tip
- Color-coded

#### Pack with 100 pieces

Article	∅	Gauge	Length	REF
Miraject Endo Luer, fine	0.3 mm	30	40 mm	254 222
Miraject Endo Luer, medium	0.5 mm	25	40 mm	254 215



## Miraject® Endotec Luer

### Special canula for rinsing with lateral opening

- Extra gentle, effective rinsing process
- Lateral opening avoids pressure on the apex
- Round canula end – low perforation risk
- Also ideal for gentle rinsing of periodontal pockets
- Sterile packed
- For syringes with Luer tip
- Color-coded

#### Pack with 25 pieces

Article	∅	Gauge	Length	REF
Miraject Endotec Luer	0.8 mm	21	25 mm	254 216
Miraject Endotec Luer	0.6 mm	23	25 mm	254 217
Miraject Endotec Luer	0.5 mm	25	25 mm	254 218
Miraject Endotec Luer	0.4 mm	27	25 mm	254 228
Miraject Endotec Luer	0.3 mm	30	25 mm	254 219





## Miraject® Endotec Duo

### Special canula with two lateral openings

- Extra gentle, effective rinsing process
- Two lateral openings avoid pressure on the apex
- Round canula end – low perforation risk
- Also ideal for gentle rinsing of periodontal pockets
- Sterile packed
- For syringes with Luer tip
- Color-coded

#### Pack with 25 pieces

Article	ø	Gauge	Length	REF
Miraject Endotec Duo	0.6 mm	23	25 mm	254 230
Miraject Endotec Duo	0.5 mm	25	25 mm	254 231
Miraject Endotec Duo	0.4 mm	27	25 mm	254 232
Miraject Endotec Duo	0.3 mm	30	25 mm	254 233



## Miraject®

### The injection canula on the dental market

- The classic disposable canula for cylinder ampoules
- Has been the hallmark of quality for more than 60 years: over 400 million Miraject canulas meeting highest quality standards
- Manufactured under strictest quality controls
- Meets the highest requirements of injection hygiene, every needle is equipped with a sterility control seal
- Triple lancet cut – almost painless
- Injection mark – orientation
- Silicone coating – ideal gliding behaviour

#### Pack with 100 pieces

Article	ø	Gauge	Length	REF
Miraject 17/42	0.5 mm	25	35 mm	254 200
Miraject 17/23	0.5 mm	25	21 mm	254 201
Miraject 30/42	0.4 mm	27	35 mm	254 202
Miraject 30/23	0.4 mm	27	21 mm	254 203
Miraject 40/23	0.3 mm	30	21 mm	254 204

Short canula for intraligamentary anaesthesia (not suitable for the Miramatic system):

Article	ø	Gauge	Length	REF
Miraject 40/10	0.3 mm	30	10 mm	254 205

## Miraject® Luer

### Injection canula with plastic Luer cone

- For injection solutions from an ampoule
- For any conventional disposable syringe
- Individually and sterile packed
- Color-coded

#### Pack with 100 pieces

Article	ø	Gauge	Length	REF
Miraject Luer 17/42	0.5 mm	25	42 mm	254 210
Miraject Luer 17/23	0.5 mm	25	23 mm	254 211
Miraject Luer 30/42	0.4 mm	27	42 mm	254 212
Miraject Luer 30/23	0.4 mm	27	23 mm	254 213



## Miraject® Flexi Tip

### Application tips with Luer-Lock

- Blunt plastic needle pre-bent tip
- Very flexible and form stable
- For exact application and dosing of highly fluid pastes and liquids
- Single use only

Article	REF
Miraject Flexi Tip 21G, ø 0,6 – 0,8 mm x 24 mm (25 single use tips) medium	254 241
Miraject Flexi Tip 27G, ø 0,2 – 0,4 mm x 20 mm (25 single use tips) fine	254 242



Miraject Flexi Tip 21G  
ø 0,6 – 0,8 mm x 24 mm

Miraject Flexi Tip 27G  
ø 0,2 – 0,4 mm x 20 mm

## Miramatic® Holder Plus

### Solid safety stand for injection syringes and rinsing canulas

- No risk of injury from needles lying open on the cart
- One-hand re-capping reduces injury risk
- Syringe sits upright in its own protective cover
- Fixing clamp holds the protective cover tightly
- Stainless steel, approx. 240 g

Article	REF
Miramatic Holder Plus	355 466
Miramatic Holder	355 465



### Miramatic® Holder

- Syringe sits upright in its own protective cover
- 200 g of safe stability
- Stainless steel, autoclavable

## Miramatic®-Box

### Patented disposal box

- With automatic lid, opening itself at the push of a button
- Disposal of used canulas and other products contaminated with blood and saliva, such as scalpels, disposable syringes and suchlike
- Absolutely safe storage due to firmly fixed lid with safety lock
- Opening for unlocking the Miramatic syringe and for disposal of the Miraject canulas
- The opening can be enlarged gradually by pushing out the flap
- Table fixing device for firm placing of the box

Article	REF
5 boxes, 1 table fixing device	355 468
Table fixing device, separately	355 472



Content: 2,1 l

✓ Miramatic-Safety-System



✗ Needlestick Injury

Makes it easy to adhere to the EU-Directive 2010/32/EU regarding prevention of injuries caused by sharp/pointed instruments.



## Apply-Tips®

### Fine application tips

- For precise application of liquids and pastes
- Bendable ends for hard-to-access areas
- Economic use of expensive materials (such as bondings, medicaments, etc.)
- Acid-resistant against bonding and other materials
- Hygienic dispenser box for single removal
- Available in three sizes

Article	Content	REF
Apply-Tips, medium (regular), blue handle	100 pcs.	605 510
Apply-Tips, medium (regular), blue handle	5 x 100 pcs.	605 511
Apply-Tips, fine, white handle	100 pcs.	605 512
Apply-Tips, fine, white handle	5 x 100 pcs.	605 513
Apply-Tips, conical, green handle	100 pcs.	605 514
Apply-Tips, conical, green handle	5 x 100 pcs.	605 515



## Pick up Stick

### Adhesive application aid

- Bendable stick with adhesive wax tip
- Ideal for quick and precise pick-up of crowns, inlays, veneers

Article	Content	REF
Pick up Stick	30 pcs.	605 423



## Twin-Pipette

### Pipette with two chambers

- For measuring out the exact dosage of drops or for thorough rinsing
- Front chamber = drops, rear chamber = rinsing
- Pipette end can be cut off for increased flow, e.g. for subgingival rinsing

Article	Content	REF
Twin-Pipette	100 pcs.	605 352

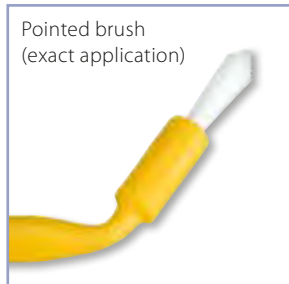

## Mirabrush®

### Bendable application brush

- One-piece disposable brush
- Bendable: can be bended into any angle
- Time-saving: no changing of brushes
- Safe: no danger of cross infection
- Yellow handle = pointed brush, exact application
- Blue handle = flat brush, surface application

### Dispenser pack

Article	Content	REF
Mirabrush regular 10 cm, yellow/pointed	100 pcs.	605 460
Mirabrush, regular 10 cm, blue/flat	100 pcs.	605 461

## Reso-Pac®

### Adhesive periodontal dressing based on cellulose

- To be applied directly to wounds, sutures and pressure spots
- Keeps out bacteria and assists the healing process
- Remains for up to 30 hours and is self-dissolving
- Ideal for protection of wounds and sutures in implantology, periodontics, following extractions, in orthodontics and prosthodontics
- Ideal as a medicament carrier
- Patient-friendly as it stays soft, is odorless and neutral in taste



Article	Content	REF
Reso-Pac	25 g	155 011
Reso-Pac value pack	5 x 25 g	155 010
Reso-Pac single portions	50 x 2 g	155 014



2 g

## Miradont®-Gel

### Micronutrient gel for intensive oral care

- Accompanying therapy in aphthae and oral lesions
- Regenerating and revitalizing
- For irritated and stressed oral mucosa
- No added alcohol, saccharin, menthol, and preservatives

Article	Content	REF
Miradont-Gel	15 ml	155 000

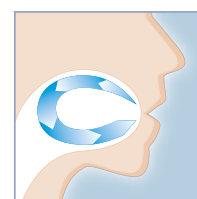



Often requires laborious adaptation



Perfect fit

## Miratray® Implant

### Implant impression tray with patented foil technique

- Saves you and your patient an additional patient visit and laboratory costs
- Controllable and safe impression taking with clear view of implant posts
- As foil meets precisely at implant posts, a clean impression is taken
- No overflowing impression material
- Customizable, user-friendly and cost-effective
- Available in three sizes for maxilla and mandible (dentulous and edentulous)
- Suitable for all implant impression materials and implant systems

“Making an individual tray in laboratory is no longer necessary = time saving (appointment) and cost saving for the patient.”  
Petra Weidenmüller, Magdeburg

Article	Size	Content	REF
Miratray Implant Intro Kit 6 x 1 piece (Upper/Lower small, medium, large)		6 pcs.	101 250
Miratray Implant, Upper, S1	small	6 pcs.	101 251
Miratray Implant, Upper, S2	medium	6 pcs.	101 252
Miratray Implant, Upper, S3	large	6 pcs.	101 253
Miratray Implant, Lower, I1	small	6 pcs.	101 254
Miratray Implant, Lower, I2	medium	6 pcs.	101 255
Miratray Implant, Lower, I3	large	6 pcs.	101 256



Strengthened sides

Tearproof net material

## Miratray® 3 in 1

### 3 work steps in one – impression, counter impression, bite registration

- Time saving: A double impression is taken (upper jaw and lower jaw) in just one step
- Material savings: Partial impression with direct correlation of the occlusion
- Patient-friendly: Faster and less gag reflex
- Sheer, tearproof net material
- Dimensionally stable
- Color-coded

Article		Content	REF
Miratray 3 in 1, Posterior, green	●	36 pcs.	101 270
Miratray 3 in 1, Quadrant, yellow	●	36 pcs.	101 271
Miratray 3 in 1, Anterior, purple	●	32 pcs.	101 272
Miratray 3 in 1, Full Arch, blue	●	28 pcs.	101 273





## Miratray®-Mini

For single impressions of crowns and small bridges

- Inexpensive disposable plastic tray
- Can easily be slid onto corrugated tweezers
- Excellent for patients, avoids gag reflex
- Saves impression material

Article	Content	REF
Miratray-Mini	50 pcs.	101 102



Save impression material and plastic

## Miratray® Partial

Partial plastic impression tray in three shapes

- Excellent for patients feeling an urge to gag
- Saves impression material

Article	Content	REF
Miratray Partial, bag, PR right	12 pcs.	101 178
Miratray Partial, box, PR right	100 pcs.	101 148
Miratray Partial, bag, PL left	12 pcs.	101 176
Miratray Partial, box, PL left	100 pcs.	101 146
Miratray Partial, bag, PM middle	12 pcs.	101 177
Miratray Partial, box, PM middle	100 pcs.	101 147
Miratray Partial, Assortment II, all 3 shapes assorted	100 pcs.	101 151

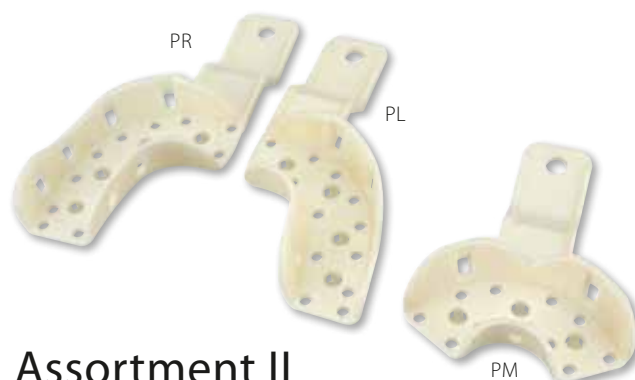

### Assortment II

100 partial trays in three shapes, assorted:  
 Shape: PL PR PM  
 Quantity: 33 33 34

## Miratray®

Disposable impression tray made of white plastic

- Inexpensive and solid
- Excellent retention of the impression material by special "retention baskets"
- Practical: can be labelled with felt-tip pen
- Complete tray available in three sizes (s, m, l)

Article	Size	Content	REF
Miratray, Upper, S1	small	50 pcs.	101 140
Miratray, Upper, S2	medium	50 pcs.	101 141
Miratray, Upper, S3	large	50 pcs.	101 142
Miratray, Upper, I1	small	50 pcs.	101 143
Miratray, Upper, I2	medium	50 pcs.	101 144
Miratray, Upper, I3	large	50 pcs.	101 145
Miratray, Upper, S1	small	12 pcs.	101 170
Miratray, Upper, S2	medium	12 pcs.	101 171
Miratray, Upper, S3	large	12 pcs.	101 172
Miratray, Upper, I1	small	12 pcs.	101 173
Miratray, Upper, I2	medium	12 pcs.	101 174
Miratray, Upper, I3	large	12 pcs.	101 175
Assortment I, assorted		50 pcs.	101 149

S = Superior, I = Inferior

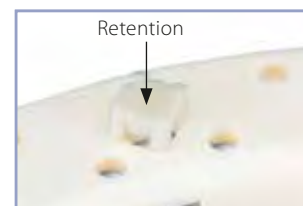

### Assortment I

50 complete/partial trays in nine designs, assorted:  
 Shape: I2 S2 S3 S1 I1 I3 PL PR PM  
 Quantity: 10 10 5 5 5 5 3 3 4



## Miratray® Spray

### Adhesive spray

- Ideal spray bonding agent for impression trays
- For better adhesion of the impression material to both, plastic and metal trays
- Use only in combination with impression material

Article	Content	REF
Miratray Spray	200 ml	554 210



Autoclavable



## Algilock®

### Extremely durable impression tray

- "Retention rims" hold the impression material without adhesives
- Laser-welded handles and ridges for a solid interconnection
- For dentulous jaws
- High-quality, corrosion-resistant stainless steel
- High durability, highest shape stability and long-term good appearance
- Autoclavable without loss of quality
- Only Algilock offers such a unique model variety and solid top quality
- On request, Algilock is available for maxilla and mandible as:
  - Algilock partial (perforated/non-perforated)
  - Algilock pedo (orthodontology)
  - Algilock edentulous (perforated)

Article	Size	USA	REF
Algilock, Upper, BS 5	xx-large	U11	101 006
Algilock, Upper, BS 3	x-large	U12	101 004
Algilock, Upper, BS 2A	large	U13	101 042
Algilock, Upper, BS 2	medium	U14	101 003
Algilock, Upper, BS 1	small	U15	101 002
Algilock, Upper, BI 5	xx-large	L11	101 011
Algilock, Upper, BI 3	x-large	L12	101 009
Algilock, Upper, BI 2A	large	L13	101 043
Algilock, Upper, BI 2	medium	L14	101 008
Algilock, Upper, BI 1	small	L15	101 007
Set with 10 trays (5 upper, 5 lower)			101 001

BS = Dentulous Superior BI = Dentulous Imperior

## Algilock® Perforiert

### Perforated impression tray

- For dentulous jaws
- High-grade corrosion resistant stainless steel
- Top quality, long lasting, brilliant finish and form stability
- Retention rims hold impression material – no adhesive necessary
- Laser-welded handles and palatine ridge
- Autoclavable without affecting finish

Article	Size	USA	REF
Algilock Perforiert, Upper, PS 6	x-large	7	101 036
Algilock Perforiert, Upper, PS 5	large	5	101 034
Algilock Perforiert, Upper, PS 4	medium	4	101 033
Algilock Perforiert, Upper, PS 3	small	1	101 032
Algilock Perforiert, Upper, PI 6	x-large	24	101 041
Algilock Perforiert, Upper, PI 5	large	22	101 039
Algilock Perforiert, Upper, PI 4	medium	21	101 038
Algilock Perforiert, Upper, PI 3	small	20	101 037
Algilock Perforiert Set with 8 trays (4 upper, 4 lower)			101 031

PS = Perforated Superior PI = Perforated Imperior



## Algilock® Partiell

### Partial impression trays/half trays

- For dentulous jaws
- High-grade corrosion resistant stainless steel
- Top quality, long lasting, brilliant finish and form stability
- Retention rims hold impression material – no adhesive necessary
- Laser-welded handles and palatine ridge
- Autoclavable for many years without affecting finish

Article		REF
Algilock Partiell, Set PR and PL	unperforated	101 030
Algilock Partiell, Separate, right PPR	perforated	101 044
Algilock Partiell, Separate, left PPL	perforated	101 045



## Algilock® Pedo

### Perforated orthodontic trays – small

- For dentulous jaws, especially for pediatric dentistry

Article		REF
Algilock Pedo, Upper, PI 2		101 046
Algilock Pedo, Upper, PS 2		101 047



## Algiloid®

### Highly precise hydro impression material

- Favorable alternative to silicone impressions
- The tray remains in the mouth for only approx. 3 min.
- Easy and quick handling
- Environmental-friendly disposal with household waste
- Combines the advantages of agar hydrocolloid with those of alginate
- Canula tips (package of 2) available separately upon request

#### Highly precise, inexpensive and time-saving impressions with the Algiloid System

The Algiloid system consists of algiloid hydro material as "light body" and customary alginate as "heavy body". Material must be used pre-warmed.

Article		REF
Algiloid Box of 48 cylinder ampoules		101 401
Algiloid syringe III, incl. 2 attachments		101 405



## Algilock® Cleaner Plus

### Alginate remover

- Cleaning in dipping bath without mechanical impact, no ultrasound, no scratching
- Decomposes the organic structure of the impression material, no aggressive or caustic effect, no corrosion
- Even after several cleanings impression trays do not tarnish
- Bio-degradable and pH-neutral, phosphate-free, pleasant smell
- For approx. 500 trays

Easily removes plaster and alginates from impression trays, instruments and spatulas. No laborious and time-consuming cleaning, simply add 50 g to 1 l of warm water and leave for approx. 15 – 30 minutes. May also be used in an ultrasonic unit. Not suitable for aluminum trays.

Article	Content	REF
Algilock Cleaner Plus	1000 g	554 104





Cleaning a pair of scissors



Cleaning a scaler



Serves as cushion for endodontic needles



Wet, fogged mouth mirror



Simply wipe off on the pad



Crystal clear mouth mirror



\* Sterilize in autoclave before first use!

## Fit-N-Swipe

- High cleaning effect and highly absorbent
- Sterilizable\* and hygienic
- Easy to use
- Individually positionable in the work area

### User testimonials

Bettina Drewes, DH: "I think Fit-N-Swipe is very good. It simplifies the work in prophylaxis, where usually no assistance is available."

Melanie Graf, DCP: "Absolutely great! They're very easy to use and it's a neat thing. Glove on, swipe on, fit for the next treatment – then, together with the glove, into the trash in no time at all!"



Microfiber structure



## Fit-N-Swipe Clean

### Adhesive cleaning pads for instruments

- Unique microfiber with high retention capacity
- Serves as a safe and handy cushion for endodontic needles

Article	Content	REF
Fit-N-Swipe Clean, white	50 pcs.	605 251



Multi-layer structural fiber

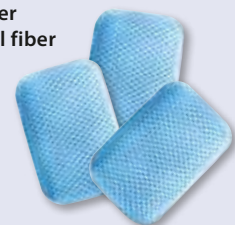

## Fit-N-Swipe Dry

### Adhesive drying pads for mouth mirrors

- Unique multi-layer fiber
- Removes even greasy or oily contaminants without leaving streaks

Article	Content	REF
Fit-N-Swipe Dry, blue	50 pcs.	605 252

## Compo Blitz Polisher

### Diamond impregnated natural felt wheel

- Buffs composites, ceramic and porcelain to a high luster finish
- Polishes in 15 sec., friction temperature <30 °C
- Mounted for C.A.
- Wheels of ø 9 mm in 2 sizes:
  - 1.5 mm/thin
  - 3 mm/thick

Article	Content	REF
Compo Blitz Polisher Set assorted, 6 each	12 pcs.	503 086
Compo Blitz Polisher, thin 1.5 mm	12 pcs.	503 087
Compo Blitz Polisher, thick 3 mm	12 pcs.	503 088



## Matrix-Spanner

### Matrix retainer "Tofflemire" style

- High-quality stainless steel
- Autoclavable



Article		REF
Matrix-Spanner, standard universal	No. 1	355 043
Matrix-Spanner, angled	No. 2	355 047
Matrix-Spanner, junior (short)	No. 3	355 048



## Cyano Fast

### Acrylic adhesive

- Normal curing bonding, adhesion and mixing fluid
- For extra-oral work

Article	Content	REF
Cyano Fast	4 bottles with 5 g each	152 261

## Cyano Pipettes

### Dispersions pipettes

Article	Content	REF
Cyano pipettes	100 pcs.	152 268





## Emmenix® Flap

### Soft bite X-ray cushion

- Special foamed material with high adhesion
- Flap can be fixed to the film optimally and anywhere
- Ideal for bitewing, front, premolar and molar X-ray pictures

Article	Content	REF
Emmenix Flap	500 pcs.	656 303

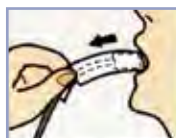
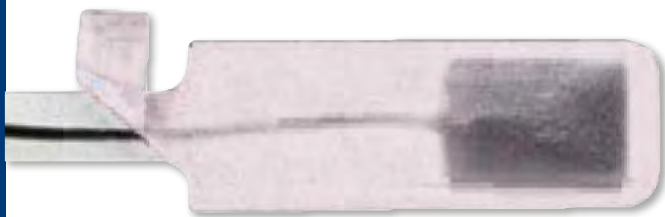
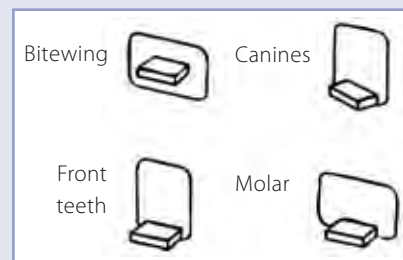

## Salibag

### Protective pouch for X-ray sensors

- Sensor gets inserted in the protective pouch and placed in the patient's mouth for radiography
- Protects the patient, the practice personnel and the sensor against humidity, saliva and blood
- High patient comfort by soft material
- Rounded edges, no risk of irritation
- Size: 36 x 105 mm

Article	Content	REF
Salibag, SLB-L, for CCD Sensor S/M	320 pcs.	656 232



## Röntgomarker

### X-ray marking pen

- Waterproof, special white ink
- Very exact, hard and thin tip

Article	REF
Röntgomarker	656 322



## Protectoray

### X-ray shield

- X-ray protection shield for the patient
- Safe by 0.5 mm lead lining
- In compliance with DIN 6813
- Approved by the German Institute of Radiation Safety, Munich, Germany
- Convenient for the patient – no heavy lead apron
- Easy exchange of handle



Protectoray wall mount

Article	REF
Shield and handle	656 127
Wall holder separately transparent	656 128
Handle separately, exchangeable	656 701

Wall holder separately blue, silver or white

**on  
request**



## Emmenix® Film Holder

### Hygienic X-ray film holder

- Film is easily positioned in the patient's mouth without the use of a finger (no irritation of mucosa, no gag reflex)
- Precise, as no bending of the film, no distortion of the picture
- For pictures of anterior teeth and molars, especially wisdom teeth
- Autoclavable, high-quality, unbreakable plastic
- In three colors: white, blue, gray

Article	REF
Emmenix Film Holder Pack with 3 holders, assorted	656 300



## Flexbrush

### Autoclavable nail brush

- Excellent for the cleaning of hands before and after treatment
- Extra long, hard-wearing bristles on the bottom
- Short bristles on the top
- Autoclavable – meeting hygiene requirements

Article	REF
Flexbrush	605 254



ø 23 mm



ø 19 mm



ANTI-FOG



ø 19 mm

ANTI-FOG



Protective foil



## Brillant

### Disposable mouth mirror made of plastic



- Without anti-fog coating
- Available in two sizes, ø 19 mm and ø 23 mm
- Each mirror protected with foil and single packed, 100 pieces

Article	Content	REF
Brillant No. 4, white, ø 19 mm	100 pcs.	605 400
Brillant No. 5, white, ø 23 mm	100 pcs.	605 399

## Brillant Anti-Fog

### Disposable anti-fog mouth mirror made of plastic

- With anti-fog coating
- Flat, angled mirror head for access to all areas in the oral cavity
- Ergonomic finger-grip handle
- Each mirror protected with peel off foil and single packed

Article	Content	REF
Brillant Anti-Fog, white, ø 19 mm	50 pcs.	605 416
Brillant Anti-Fog, transparent blue, ø 19 mm	50 pcs.	605 417

## Mirodent

### Plastic, disposable mouth mirror

- No misting due to „anti-fog coating“
- Mirror can be removed from the handle and be replaced by a new mirror, reduces waste

Article	REF
Mirodent, 100 mirrors + 4 handles (one-ended)	605 404
Mirodent, one-ended handle	605 405

## Durotanic® Mouth Mirror

### Rhodium-coated front mirror

- Rust-proof high quality
- Durable, distortion-free, sterilizable
- Small "slimline" head

Article	Content	REF
Durotanic Mouth Mirror size 4	12 pcs.	355 453
Durotanic Mouth Mirror size 5	12 pcs.	355 454

## Variator®-Kit

### Disposable treatment set

- Comprises mouth mirror, tweezers and probe
- Big spatula for mixing of cement and filling materials
- Ball head and Heidemann spatula for stuffing
- Practical for home visits, high-risk patients and in emergencies
- All three instruments are sterile and blister-packed as a unit

Article	Content	REF
Variator-Kit, set with 3 instruments	10 sets	355 441



## Reflect-Rhod

### Rhodium-coated metal mouth mirror

- Ideal for distortion-free intra-oral photos
- Extensive rhodium coating on one side
- Sturdy, durable
- With detachable silicone handle
- Autoclavable in the provided fabric bag

Article		REF
Reflect-Rhod Set with 3 mirrors		355 480
Reflect-Rhod No. 1, separately	(40 x 163 mm)	355 481
Reflect-Rhod No. 2, separately	(69 x 163 mm)	355 482
Reflect-Rhod No. 3, separately	(79 x 163 mm)	355 483
Silicone handle separately	(40 x 52 mm)	355 487

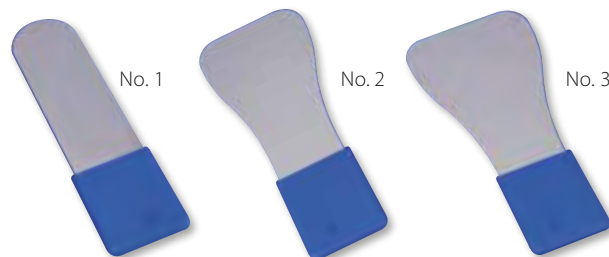

## Parallelometer-Mirror

### Mirror with parallel lines

- A proven specialty according to Prof. Böttger
- Fits all popular mirror handles (excluded from scope of delivery)
- Parallel check before imprint
- Autoclavable

Article	REF
Parallelometer-Mirror	355 470



## Liftbox

### Disinfection box for dental instruments

- By closing the cover, the filled tray submerges into the disinfectant
- Tray with swivel handle for easy handling
- No direct skin contact with aggressive disinfectants
- Acid-resistant plastic
- Container content: approx. 1.5 l

Article	REF
Liftbox	355 140



Dimensions (W x H x D)  
approx. 26 x 8.5 x 12 cm



## Spandex®

### Cheek and lip retractor

- Allows for a free view and working field
- Ideal for treatment of anterior teeth
- Made of non-reflecting plastic
- Autoclavable



Article	Content	REF
Spandex regular	2 pcs.	605 454
Spandex mini (children)	2 pcs.	605 455



## Spandex®-Vertical

### Lip retractor

- Expands patients mouth in vertical direction
- For treatment at the gingival border of anterior teeth
- Autoclavable

Article	Content	REF
Spandex-Vertical	4 pcs. (2 x medium, 2 x small)	605 211



## Mirahold®

### One sided cheek retractor

- With long handle for a free working field
- Useful, e.g. for injections
- Convenient for the patient
- Autoclavable



Article	Content	REF
Mirahold regular	2 pcs.	605 450
Mirahold bambino	2 pcs.	605 451



## Mirahold®-Block

### Elastic bite blocks for mouth opening

- Plastic block to keep the mouth open reliably
- The set includes a special cheek retractor
- Ideal for longer treatments and anxious patients
- Autoclavable

Article	REF
Mirahold-Block Set with 12 bite blocks, 6 small and large each and 2 cheek retractors	605 210
Mirahold-Block Intro set with 6 bite blocks, 3 small and large each and 1 cheek retractor	605 238
Mirahold-Block Mini set with 3 bite blocks (small)	605 220
Mirahold-Block Cheek retractor separately	605 239

## Crown Click® De Luxe

### Mechanical crown and bridge remover

- Very effective due to impulse wave
- Just place the instrument tip underneath the crown rim and release the "click"
- Instrument tip in three designs with additional loop (optional)
- Fast, efficient and easy crown and bridge removal
- High-quality, mattfinished stainless steel
- Autoclavable



Article	REF
Crown Click De Luxe Set: instrument with tips (No. 1 – 3)	452 205
Crown Click De Luxe Tip No. 1 (long)	452 206
Crown Click De Luxe Tip No. 2 (short)	452 207
Crown Click De Luxe Tip No. 3 (short + angle)	452 208
Crown Click De Luxe Loop tip No. 4 (incl. adapter)	452 209
Crown Click De Luxe Loop tip replacement wire, 2 pcs.	452 210



## Artiholder

### Miller Forceps

- Artiholder in straight form
- Ideal for posterior teeth
- Stainless steel

Article	REF
Artiholder	355 300



## Gripit®

### Bite cushion with high adhesion force

- For removal of temporary work
- Heat bite cushion, put in place and remove temporary work by instructing the patient to open their mouth jerkily
- Safe and very convenient for the patient
- Two pieces hygienically packed

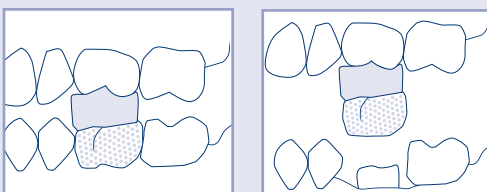

Article	Content	REF
Gripit	50 (25 x 2) pcs.	605 283



## BD-Steribox

### Container for disinfection

- Useful for small parts, such as burs, diamonds, etc.
- With opening in the lid
- With removable sieve for rinsing the content
- Both versions autoclavable
- Dimensions: Plastic: Total height approx. 12 cm,  $\varnothing$  approx. 8 cm  
Metal: Total height approx. 5 cm,  $\varnothing$  approx. 9 cm

Article	REF
BD-Steribox plastic	355 139
BD-Steribox metal	355 138



## Clip-Clap

### Stainless steel mesh

- Ideal for ultrasonic cleaning
- To safely scald sensitive small parts
- 45 mm diameter of ball-shaped strainer

Article	REF
Clip-Clap	304 140



250 ml

500 ml

## Dosing Bottle

### Transparent squeeze bottles

- With fine jet tip and delivering tube
- For fine dosing of liquids
- In two sizes

Article	Content	REF
Dosing Bottle	250 ml	304 405
Dosing Bottle	500 ml	304 406

## Miraclip

### Napkin holders

- Made of autoclavable rubber material with stainless steel clips

Article	REF
Miraclip, blue	605 240
Miraclip, yellow	605 241
Miraclip, violet	605 242 </td
Miraclip, white	605 243
Miraclip Set of 4, 1 of each color	605 228



Total length 42 cm

## Fit-N-Fix

### Disposable, hygienic napkin holder

- Easy to use: Remove protective foil and stick to paper napkin
- Stretch material made of soft silk like fiber for patient comfort
- Works with all bibs
- Easy handling and hygienic disposal
- Two flowery colors

Article	Content	REF
Fit-N-Fix, blue	200 pcs.	605 249
Fit-N-Fix, pink	200 pcs.	605 250



Length 38 cm

## Cotton-Clip

### Cotton roll holder

- Holds cotton rolls securely in place for a dry working field

Article	Content	REF
Cotton-Clip I	100 pcs.	605 350



## Cottoroll

### Cotton roll dispenser

- Hygienic, dry storage
- Quick and easy to access – simply open the drawer
- Drawer refills automatically
- Convenient top-loading function
- Stable, nonslip

Article	REF
Cottoroll	355 132



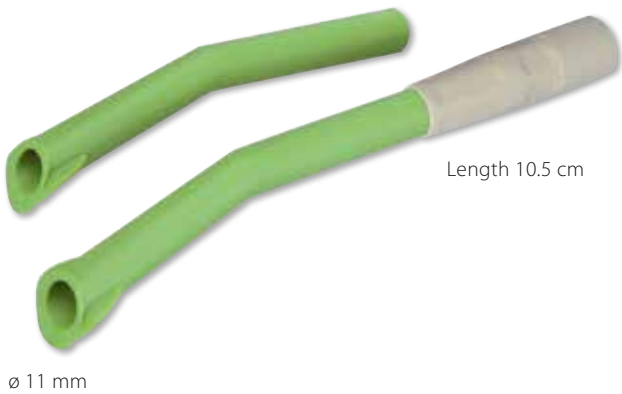

## Pelotte Plus

### Autoclavable plastic aspiration canula

- Very convenient for the patient, with round head
- Also ideal in pediatric dentistry
- ø 11 mm, length 10.5 cm
- Autoclavable

Article	Content	REF
Pelotte Plus, green incl. 1 adapter	10 pcs.	254 024



## Pelotte-Aspirator

### Disposable plastic aspiration canula

- Canula with round head
- ø 11 mm, length 10 cm

Article	Content	REF
Pelotte-Aspirator, white	50 pcs.	254 022
Pelotte-Aspirator, orange	50 pcs.	254 023



## Mirasucto®

### Longer disposable plastic aspiration canula

- With square head
- ø 11 mm, length 14 cm

Article	Content	REF
Mirasucto, white	50 pcs.	254 020
Mirasucto, orange	50 pcs.	254 021

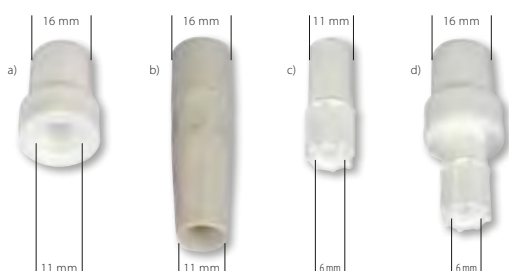

Similar to illustration

## Mirasuc® Adapter

### Extensions and connecting pieces for aspiration canulas

- Made of plastic, for all conventional suction units
- Extension from 6 mm to 16 mm (d) possible by combination of adapters (a) and (c)

Article	REF
a) White, autoclavable, from 11 mm to 16 mm	254 130
b) Gray, utoclavable, finger-grip handle extends the canula from 11 mm to 16 mm	254 133
c) White, from 6 mm (salvia ejector) to 11 mm	254 132
d) Combination of adapter a) und c) from 6 mm to 16 mm	

## Chirurgo-Suc I

### Sterile disposable surgical aspiration canula

- Extremely long (20 cm) for a free working field
- Fits all hoses with adapter
- Transparent plastic
- Individually sterile sealed
- Canula diameter: 2 mm

Article	Content	REF
Chirurgo-Suc I	10 pcs.	254 000



## Steri-Suc-Tube

### Surgical aspiration canula

- Made of high-quality, transparent, honey-colored plastic
- Safe when getting into contact with activated electrodes (e.g. page 71) or rotating instruments
- Autoclavable
- Fits to saliva ejector (6 mm) without adapter
- Ultra-light, approx. 3 g weight
- Incl. one Chiru-Cleaner brush (No. 19, REF 605 215)

Article	Content	REF
Steri-Suc-Tube	10 pcs.	254 060



## Chiru-Cleaner®

### Cleaning brushes for surgical canulas

Article	Content	REF
a) Chiru-Cleaner 23, 23 cm long	12 pcs.	605 215
b) Chiru-Cleaner 16, 16 cm long	6 pcs.	605 217

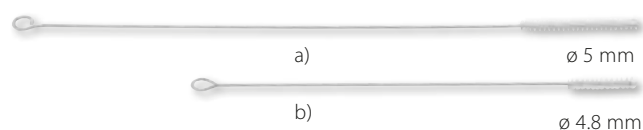

## Mirasuc® Brush

### Cleaning brush for aspiration canulas

- Bendable, ideal for the cleaning inside of canulas
- For all aspiration canulas with ø 11 mm and 16 mm, length 18.5 cm

Article	Content	REF
Mirasuc Brush	6 pcs.	605 216





## Cold-Bag

### Cold compress for pain relief

- Immediate activation, cools for approx. 30 min. (at 4 °C)
- Effective pain reduction
- Resorption of hematomas and swellings
- Not harmful to the environment

Article	Content	REF
Cold-Bag	10 pcs.	605 501



## Miracold® Plus

### Cooling spray

- Approx. -50 °C at the application canula (plastic)
- Orange flavor
- For vitality testing of devital teeth

Article	Content	REF
Miracold Plus	200 ml	554 213



## Orange Solvent®

### Cleansing solution

- For the removal of impression pastes, zinc oxide cements, dispersion adhesive (stickers, labels) from instruments
- Ideal for cleaning stainless steel
- Surfaces become shiny and are protected
- Fresh orange scent
- Available as liquid and spray

Article	Content	REF
Orange Solvent liquid	250 ml	554 102
Orange Solvent spray	200 ml	554 201



## Praxipolish® Plus

### Cleansing foam for dental practices

- Removes dirt, dirt rims, stains, etc. without effort
- For devices, plastic and wooden surfaces, etc.
- With ultra-hygienic features
- Tested by the neutral German "Institute for Hospital Hygiene and Infection Control" (IKI Gießen)

Article	Content	REF
Praxipolish Plus	400 ml	554 208



## Del-Ject

### Plastic amalgam carrier

- Autoclavable

Article	REF
Del-Ject, 90° angle	355 036



## Amalgam Well

### Amalgam depot made of stainless steel

- Funnel-shaped for easy pick-up
- Allows pick-up of amalgam for without skin contact
- Stable and non-slip (123 g), autoclavable

Article	REF
Amalgam Well	355 000



height: approx. 3 cm /  
ø opening at the top:  
approx. 2 cm

Weight: 123 g

## Occlu® Spray Plus

### Green occlusion spray

- To mark contact points by spraying directly onto the occlusal surfaces or inside of crowns
- Micro powder layer for highest accuracy
- Plastic nozzle for fine spray mist
- Powder layer can easily be removed with water, economic consumption

Article	Content	REF
Occlu Spray Plus	75 ml	554 205
Occlu Spray Plus	50 ml	554 211



## Protho Clean®

### Cleansing and high-gloss polish of restorations

- Upgrades the presentation of your prosthetic works
- Removes polishing agent and monomer residues from prosthetic work
- Spray on and leave for a short while before wiping off with a soft cloth
- Pleasant mint flavor

Article	Content	REF
Protho Clean	75 ml	554 220





## OXYSAFE® Gel and Liquid Professional

For treatment of periodontitis and peri-implantitis

- Gel and mouthwash with active oxygen technology
- Reduction of pocket depth
- Pocket disinfection and accelerated wound healing
- Easy and precise application

Article	Content	REF
OXYSAFE Intro Kit	3 x 1 ml Gel, 3 x 250 ml Liquid + 3 x application canulas	155 040
OXYSAFE Gel	3 syringes à 1 ml (Refill)	155 041
OXYSAFE Liquid	250 ml	155 042

No antibiotics  
No CHX  
Over 20 years  
clinical experience

### How does OXYSAFE® Professional work?

OXYSAFE Gel Professional contains a patented Ardox-X® technology based on active oxygen (hydrocarbon oxoborate complex), which, due to its activity and small size, can penetrate the biofilm and is effective there in two ways. The oxygen cannot be metabolized by the anaerobic bacteria involved in the inflammatory process. Consequently, the biofilm is weakened and its functionality is disturbed. At the same time, the oxygen supports the surrounding soft tissue in healing. In addition, a new formation of the biofilm is inhibited. Oxygen protects the oral flora and does neither attack mucosa cells nor osteoblasts.

### How is OXYSAFE® used?

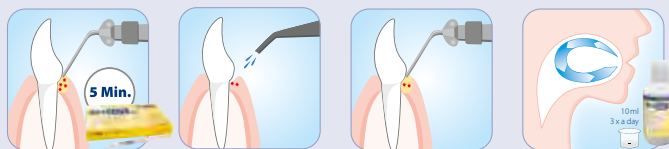

First direct application of the gel into the dental pocket

Cleaning of the gingival pocket

Second direct application of the gel in the gingival pocket – leave it there

Patient continues treatment at home



Patient situation after therapy by means of metronidazole, CHX chips, aPDT and other measures after the 3rd recall



Application of the OXYSAFE gel in situ



Patient situation 3 weeks after the start of oxygen treatment with OXYSAFE Professional

### User testimonials

Dani Müller, DCP: "Easy to use, killing anaerobic bacteria with oxygen."

Natascha Thiem, DCP: "A great enrichment as the handling and use are simple and very effective."

Christina Eilers, DH: "I find OXYSAFE Professional a good addition to PA therapy since it supports wound healing."

## Mira Clean

### Mouth rinsing tablets for dissolving

- Refreshing, cleaning, cooling
- The little extra service for the patient
- Ideal for prophylaxis treatments
- Pastilles dissolve completely within max. three minutes
- In two pleasant flavors: mint and thymol

Article	Content	REF
Mira Clean, mint, green	1,000 pastilles	605 504
Mira Clean, thymol, pink	1,000 pastilles	605 505



## Mirafloss® Big

### Wall-mountable dispensing box

- Ideal for professional use in practice
- One-handed operation using sharp metal edge
- Refillable

Article	Content	REF
Mirafloss Big (white, waxed/black, waxed, mint)	2 x 200 m	605 735
Mirafloss Big refill: black, waxed, mint	200 m	605 737
Mirafloss Big refill white, waxed	200 m	605 736
Mirafloss Big refill: white, unwaxed	200 m	605 738



## Myzotect®-Tincture

### Myrrh-Benzoin-Tincture to calm and relieve stressed oral mucosa

- After periodontal or surgical treatment
- Myrrh (tissue-firming and nurturing effect) helps in aftereffects of dental and gingival treatments
- Benzoin is germicidal and antiseptic, while aloe supports the tissue with a nourishing care
- Contains neither antibiotics nor corticosteroids
- No burning after application, sticks to the mucosa for a long time due to its syrupy consistency
- For more than 100 applications

Article	Content	REF
Myzotect-Tincture	5 ml	155 008
Myzotect-Tincture	50 ml	155 005

#### For the patient's use at home

Article	Content	REF
Myzotect-Tincture	5 x 5 ml	155 006
Myzotect-Tincture	10 x 5 ml	155 007

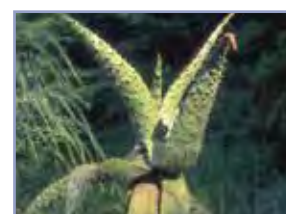

Ideal in combination with Reso-Pac (see page 15)





## Mira-Clin P®

### Intensive cleaning polishing paste

- For professional tooth cleaning in the dental practice
- Excellent cleaning effect
- Gently removes plaque and discoloration
- Maintains the hard substance of the teeth
- Fluoride-free, pleasant fruity flavor

Article	Content	REF
Mira-Clin P	250 g	605 656
Mira-Clin P Box	200 cups (2 g each) and stainless steel finger ring II	605 658
Finger ring II, separately		605 444

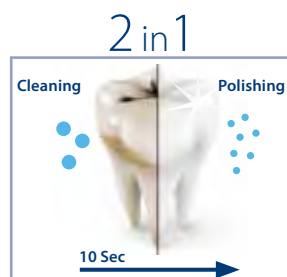

## Mira-Clin® hap

### Polishing paste with hydroxyapatite

- For professional tooth cleaning and polishing
- For the gentle care of sensitive tooth necks
- Gently removes plaque and discoloration
- Builds a protective layer on teeth and tooth necks
- Maintains the hard substance of the teeth

Article	Content	REF
Mira-Clin hap	75 ml	605 654
Mira-Clin hap, cups	100 pcs. à 2 g	605 661



## Dapp-a-Way

### Disposable dappen cups

- Set with 1,000 plastic cups

Article	Content	REF
Dapp-a-Way Set incl. 1 finger ring	1000 pcs.	605 445
Dapp-a-Way Finger ring separately		605 446

## Prophy-Ring

### Stainless steel holder for dappen cups

- Practical metal ring for attaching to the finger
- For chairside application

Article	REF
Prophy-Ring	605 657

## Mirafluor®-Tray

### Application tray for fluoride gel

- Made of light, flexible material
- With level indicator
- Double tray for simultaneous treatment of maxilla and mandible
- In yellow color, contrasting any gel
- Available in 3 sizes

Article	Content	REF
Mirafluor-Tray, small	50 pcs.	605 620
Mirafluor-Tray, medium	50 pcs.	605 621
Mirafluor-Tray, large	50 pcs.	605 622



## mirafluor®-gel

### Fluoride gel for intensive tooth decay prophylaxis

- Strengthens the enamel
- Accelerates remineralization
- mirafluor-gel with 1.23 % fluoride

Article	Content	REF
mirafluor-gel, mint	250 ml	605 800
mirafluor-gel, strawberry	250 ml	605 801



## Mirafluorid®

### Fluoride varnish on emulsion basis with 0.15 % fluoride

- Free of solvents
- For precise application, can also be applied in a humid environment
- Aqueous polymer layer allows fluorides to diffuse and is decomposed by the saliva without causing any problems

Article	Content	REF
Mirafluorid	5 ml	605 810

We recommend our Mirabrush brushes for application (see page 14).



## Happy Morning®

### Disposable toothbrush

- Ideal for brushing teeth in the dental practice before treatment, on short trips, etc.
- Hygienically and separately packed



Article	Content	REF
Happy Morning, impregnated with toothpaste	100 pcs.	605 401
Happy Morning, without toothpaste	100 pcs.	605 403
Happy Morning Xylitol (see page 88)	50 pcs.	605 496





Disclosing makes  
the PTC  
up to 3 times  
more effective



## Mira-2-Ton®

### Plaque disclosing

- Older plaque is revealed in blue, newer plaque in pink
- Proven in the dental practice for years
- Motivating quality control for dental assistant and patient
- Erythrosine- and gluten-free
- Discolorations can be removed by brushing teeth

## Mira-2-Ton® Solution

### Plaque disclosing solution

Article	Content	REF
Mira-2-Ton Solution	60 ml	605 655

## Mira-2-Ton® Pellets

### Saturated plaque disclosing pellets

Article	Content	REF
Mira-2-Ton Pellets	250 pcs.	605 662

## Mira-2-Ton® Tablets

### Plaque test tablets

Article	Content	REF
Mira-2-Ton Tablets	6 pcs.	630 027
Mira-2-Ton Tablets	5 x 10 pcs.	605 765
Mira-2-Ton Tablets	250 pcs.	605 768
Mouth Mirror, (ø 23 mm) separately	blue transp.	630 065
Mira-2-Ton Tablets display	16 pack	635 027

For further Mira-2-Ton products see page 96.



5000 ml



#### Dosing cap

For easy-to-measure  
doses of the mouth  
rinsing solution

## paroguard®

### Mouth rinsing solution

- Remineralizing due to fluoride (250 ppm)
- Ideal for patients with limited oral hygiene
- Astringent due to hamamelis
- Anti-cariogenous due to Xylitol
- Alcohol-free

Article	Content	REF
paroguard (pump not included)	5000 ml	630 127
Pump dispenser		630 138

For further products see page 89.

## Prophy-Cup®

### Rubber cups for prophylaxis

- For single use
- Latex-free
- Available in two degrees of hardness

Article			Content	REF
Prophy-Cup, screw on	regular	blue	50 pcs.	605 832
Prophy-Cup, screw on	soft	green	50 pcs.	605 833
Prophy-Cup, snap on	regular	blue	50 pcs.	605 830
Prophy-Cup, snap on	soft	green	50 pcs.	605 831
Prophy-Cup, contra Angle	regular	blue	50 pcs.	605 834
Prophy-Cup, contra Angle	soft	green	50 pcs.	605 835



## Prophy-Angles®

### Angled rubber cups

- For single use
- BPA and latex-free
- For hand pieces only
- In two hardnesses

Article			Content	REF
Prophy-Angles	regular	violet	100 pcs.	605 836
Prophy-Angles	soft	green	100 pcs.	605 837

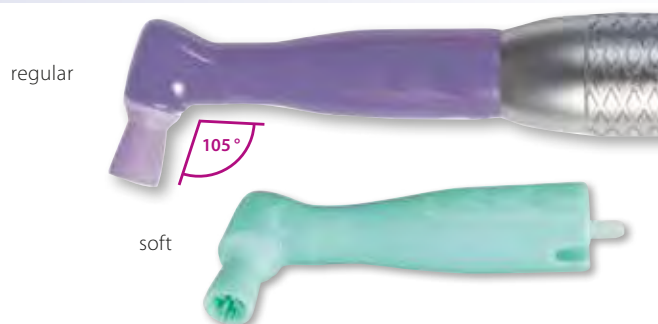

## Prophy-Brush®

### Prophylactic brushes

- For single use
- Grants optimal cleaning and polishing
- Effective biofilm removal
- For contra angles
- Available in 2 sizes

Article		Content	REF
Prophy-Brush cup, flat	regular	50 pcs.	605 871
Prophy-Brush cylinder, flat	fine	50 pcs.	605 870



## Rotoprox®

### Micro spiral brush/plastic brush with stainless steel shaft

- For cleaning and polishing e.g. fissures or inaccessible areas
- For contra-angle handpieces
- Extraoral use

#### Rotoprox Mini with stainless steel shaft

Article	Content	REF
Rotoprox Mini, straight, 20 mm long	50 pcs.	605 792

#### Rotoprox with stainless steel shaft

Article	Content	REF
Rotoprox for CA $\varnothing$ 2.0 mm X-fine/straight 27 mm long	10 pcs.	605 719
Rotoprox for CA $\varnothing$ 2.2 – 2.5 mm Fine/conical 27 mm long	10 pcs.	605 721

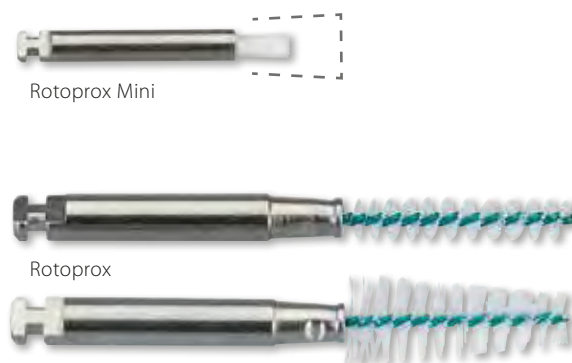



## Fit® Rubberdam Starter Kit I

Basic equipment no. I for rubber dam technique

- 1 Board with 12 clamps complete
- 1 Pair of Fit clamp forceps
- 1 Fit punch
- 1 Fit steel frame large
- 1 Fit Rubberdam booklet

## Fit® Rubberdam Starter Kit II

Basic equipment no. II for rubber dam technique

- 1 Board with 12 clamps complete
- 1 Pair of Fit clamp forceps
- 1 Fit punch
- 1 Fit latex medium (36 sheets)
- 1 Fit folding frame (plastic)
- 1 Perforated template
- 1 Fit Rubberdam booklet

Article	REF
Fit Rubberdam Starter Kit I	355 320
Fit Rubberdam Starter Kit II	355 338



## Fit® Rubberdam Clamp Board

Clamp board available with and without clamps

### Stainless steel board, with 8 clamps

2 x No. 9, 1 x each: Nos. 2A, W2A, 5, 56, 203, 204

### Stainless steel board, with 12 clamps

1 x each: Nos. 5, 7, 56, 201, 202, 206, 207, 210, 211, 0, 2, 2A

### Stainless steel board, with 18 clamps

1 x each: Nos. P1, P2, 18, 22, 27, 29, 200, 201, 202, 203, 204, 205, 208, 209, 138, 139, 210, 211

Article	REF
Clamp Board with 8 clamps	355 330
Clamp Board with 12 clamps	355 331
Clamp Board with 18 clamps	355 332
Clamp Board without clamps (for 8 clamps)	355 327
Clamp Board without clamps (for 12 clamps)	355 328
Clamp Board without clamps (for 18 clamps)	355 329



## Fit® Rubberdam Perforating Template

For marking the holes in rubber dam prior to perforation

- Solid plastic

Article	REF
Fit Rubberdam Template, 15 x 15 cm	355 318



## Fit® Rubberdam Clamp Forceps

For smooth grasp of the clamps

- Arbitrarily fixable
- No tilting of clamp
- Length: 17 cm

Article	REF
Fit Rubberdam Clamp Forceps	355 333



## Fit® Rubberdam Punch

For perfectly punched, tearproof perforations

- Movable punching pin constantly using the whole cutting border
- Made of stainless steel
- Length: 16 cm

Article	REF
Fit Rubberdam Punch	355 321



## Fit® Rubberdam-Latex

Made of natural latex rubber

- Medium: extra smooth-running due to approximal contact
- Heavy: for a stronger retention of the gingiva
- High tensile strength due to constant quality
- Durability one year minimum, if stored in a cool place
- Green sheets (15 x 15 cm), powdered on one side

Article	Thickness	Content	REF
Fit Rubberdam-Latex, medium	0.18 – 0.23 mm	36 sheet	355 335
Fit Rubberdam-Latex, heavy	0.23 – 0.29 mm	36 sheet	355 336



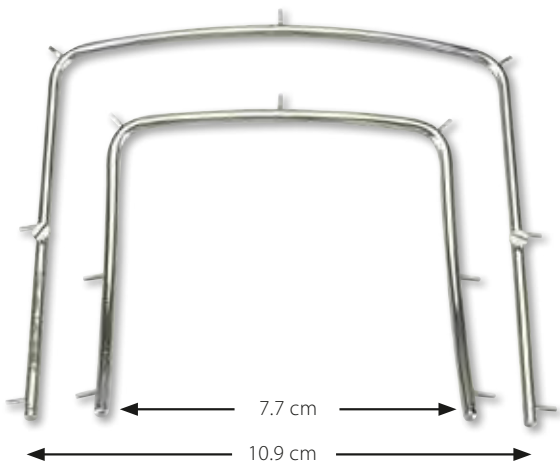

## Fit® Rubberdam Steel Frame

### Solid stainless steel frame

- For tightening of rubber dam without perforation
- Autoclavable

Article	REF
Fit Rubberdam Steel Frame I, large	355 324
Fit Rubberdam Steel Frame II, small	355 323



## Fit® Rubberdam Folding Frame

### Foldable plastic frame

- Foldable in the center, easy access
- Avoid reflections when taking X-rays, ideal for endodontics
- Autoclavable
- Weight: 16 g

Article	REF
Fit Rubberdam Folding Frame	355 319



## Fit® Rubberdam study booklet

Free 30-page Rubberdam study booklet available upon request!

Article	REF
Fit Rubberdam study booklet	160 001



Rubberdam study booklet

Our Fit Rubberdam clamps are made of stainless steel and every single one is adjusted accurately and effectively for the tooth it is intended for. 0.66 mm thick stainless steel is used for the high quality.

## Fit® Rubberdam Clamps

### Ivory-style (cervical)

Article	REF
212	355 386

### Ivory-Still (labial)

Article	REF
210	355 384
9	355 355
90N (not illustrated)	355 371

### With cotton roll holder

Article	REF
Set with clamps G-L and G-R	355 389

### For children R + L

- For the first permanent molars

Article	REF
P-R	355 387
P-L	355 388

## Fit® Rubberdam Clamps Black

### Black rubberdam clamps

- Matte surface reduces light reflection
- Glare-free when working with loopes or intraoral cameras
- High quality stainless steel

Article	REF	Article	REF
0	355 770	139	355 778
2	355 771	201	355 779
2A	355 772	202	355 780
5	355 773	206	355 781
7	355 774	207	355 782
8A	355 775	210	355 783
56	355 776	1AT	355 785
138	355 777	14T	355 786

## Fit® Rubberdam Cervical Clamp 214

### Special clamp

- For exposure of the tooth neck and for temporary retraction of the gingiva
- Screw fixation guarantees a firm grip
- Ideal e.g. for adhesive fixing of veneers

Article	REF
Cervical Clamp 214	355 400

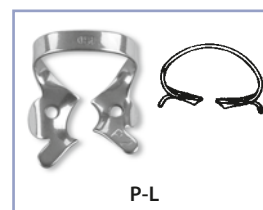
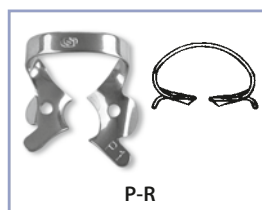
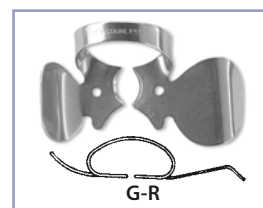
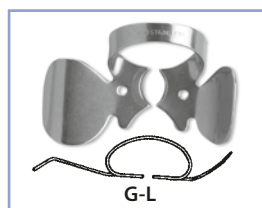
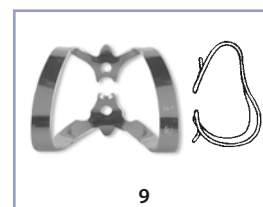
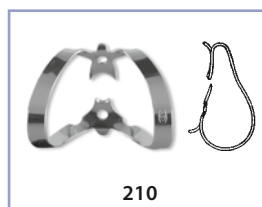



## Fit® Rubberdam T-Clamps

### Specified rubber dam T (Tiger)-clamps

- For the labial, premolar and molar area
- With special retentions for a better fixing at the tooth

#### Labial T-clamp

Article	REF
9T	355 754

#### Premolar T-clamps

Article	REF
1T	355 752
	355 753
2T	355 750
2AT	355 751

#### Molar T-clamps

Article	REF
14T	355 758
56T	355 759

## Fit® Rubberdam Clamps for Children

### Special Rubberdam clamps for children

- Especially designed for the anatomic shape of deciduous teeth
- Ideal for pediatric dentistry

Article	Quadrant	REF
55E	upper right	355 723
54D	upper right	355 722
64D	upper left	355 724
65E	upper left	355 725
85E	lower right	355 729
84D	lower right	355 728
74D	lower left	355 726
75E	lower left	355 727
Kit with 8 clamps on a clamp board		355 720
Clamp board separately, without clamps		355 721

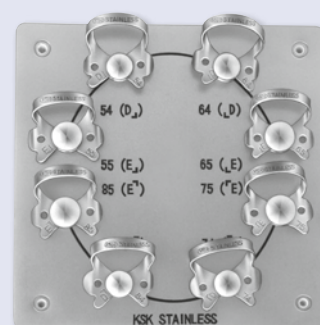

## Fit® Rubberdam Clamps

### Molar clamps wingless

Article	REF
15	355 358
18	355 359
24	355 361
25	355 362
26	355 363
28	355 365
30	355 367
31	355 368
51	355 369
138	355 372
139	355 373
W8A	355 354

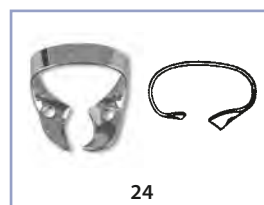

### Molar clamps with wings

Article	REF
200	355 374
201	355 375
5	355 349
56	355 370
202	355 376
205	355 379
7	355 350
203	355 377
204	355 378
7A	355 351

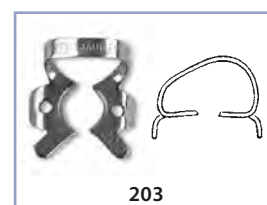
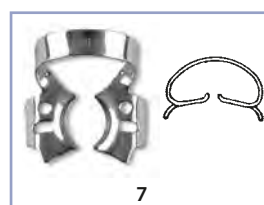
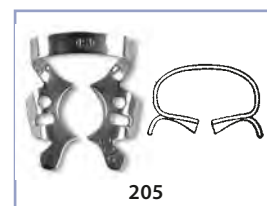
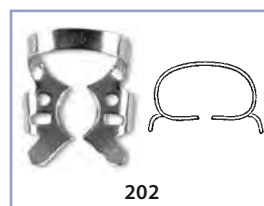
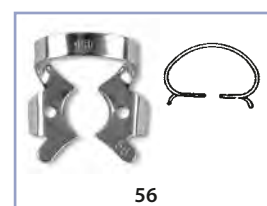
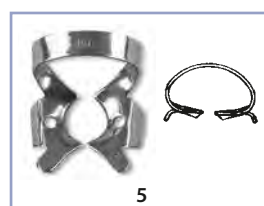
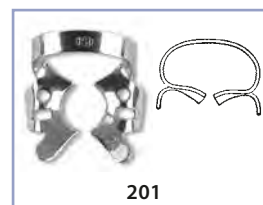
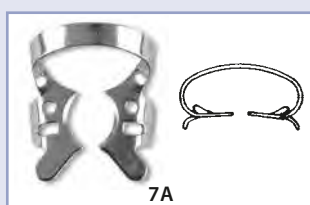
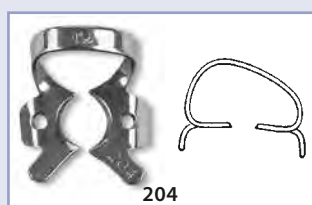

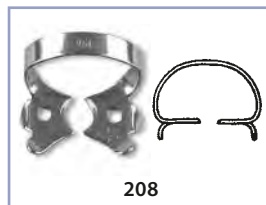
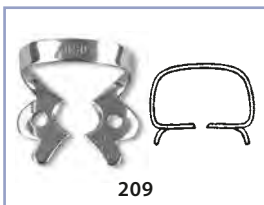
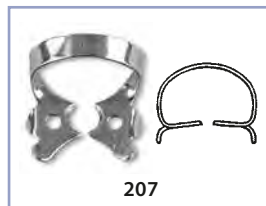
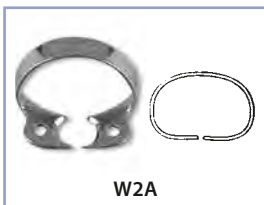

## Fit® Rubberdam Clamps

Molar clamps with wings (for deep gripping)

Article	REF
3	355 346
4	355 348
8	355 352
8A	355 353
14	355 356
14A	355 357

Should the friction of the clamp be insufficient, an activation, e.g. with pointed forceps, is possible.

## Premolar clamps wingless

Article	REF
W2A	355 345
22	355 360
27	355 364
29	355 366

## Premolar clamps with wings

Article	REF
00	355 341
0	355 340
206	355 380
207	355 381
209	355 383
208	355 382
2	355 343
2A	355 344

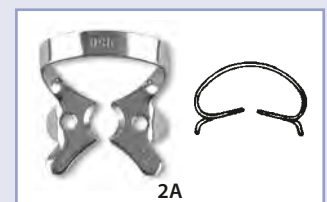
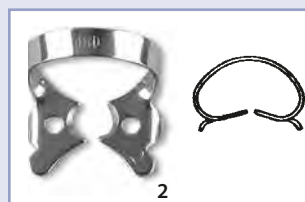

## Endo N2®

### Root canal cement on zinc oxide – eugenol basis

- Inexpensive and fast alternative for more than 50 years
- Can be used separately or as a sealer in connection with Gutta Percha points
- Easily to be rotated into the canal
- Good adhesion to canal walls
- Definite, not absorbable filling with a chalk-like hardness after curing
- Antimicrobial effect gradually decreasing with curing
- Consisting of powder and liquid for mixing

Article	Content	REF
Endo N2 Set	10 g powder, 6 g liquid	152 027
Endo N2, Powder separately	10 g	152 028
Endo N2, Liquid separately	6 g	152 029

"In more than 8,800 EDP-registered vital extirpations in the period from 1985 – 1999 the treatment needed more than one session to be finished in only 22 cases (5 own, 17 assistant). I have not counted thousands of vital amputations and milk tooth endos."  
Dr. Robert Teeuwen

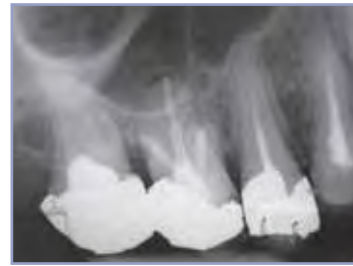

X-ray control



## Miraclean-Implant Black

### Cleaning instruments for implants

- Black colored instruments for great contrast
- Double-ended, in 4 special shapes
- Autoclavable and chemoclavable plastic material

Article	REF
Set of 4 instruments	355 220
Instrument separately: No. 1, Side tooth	355 221
Instrument separately: No. 2, Luniatschek + scaler	355 222
Instrument separately: No. 3, Anterior tooth	355 223
Instrument separately: No. 4, Abutment	355 224





6 sewed on layers

4 mm wide

## Super-Splint De Luxe

### Multilayer splinter material

- 6 sewed on layers of fine meshed, ultra-thin and silanized glass fiber tape
- 4 mm wide, for approx. 25 applications

## Super-Splint

### Glass fiber tape for splinting and strengthening

- Extremely flexible, easy-to-adapt, very easy to handle and apply
- Several layers of the tape may be arranged on top of each other with composite
- 4 mm wide, silanized tape, for up to 50 applications

Article	REF
Super-Splint De Luxe, 50 cm tape	355 848
Super-Splint, 3 m tape	355 849



## Micro-Etch

### 37 % phosphoric acid

- Viscous gel
- Dyed blue for better visualization on the enamel
- Easily measured from the syringe
- For approx. 30 applications

Article	REF
Micro-Etch, 2 ml syringe with 3 canulas	152 284

Further application needles: Miraject Endo Luer (see page 11).



## Calci-Line®

### Ready to use calcium hydroxide paste (45 %)

- For direct capping after opening of the pulp or in case of pulpomy, indirect capping in case of caries profunda
- For temporary root canal fillings and root canal disinfections
- High pH-value (over 11.5) for antimicrobial effect, radiopaque
- Economic and easy-to-measure
- Appropriate underneath all underfilling and filling materials
- Incl. curing-aid cap

Article	REF
Calci-Line, 2 ml syringe with 2 canulas	152 283

Further application needles: Miraject Endo Luer (see page 11).



# Mirapost®

## Inexpensive build-up post

- Self-cutting thread
- In two versions: titanium and 24 carat gold-plated
- Gets directly screwed in or cemented
- In four lengths: short (8 mm), medium (9.5 mm), long (12 mm), x-long (14 mm)
- In six diameters: No. 1 (1.05 mm), No. 2 (1.20 mm), No. 3 (1.35 mm), No. 4 (1.50 mm), No. 5 (1.65 mm), No. 6 (1.80 mm)
- Sets include three, six or twelve posts per size

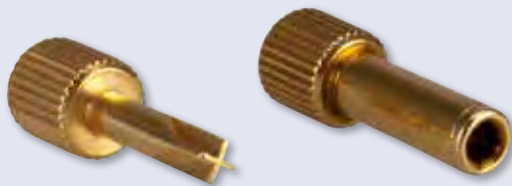
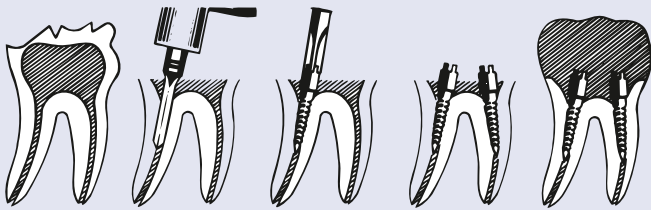

### Gold-plated set with hollow and cross-type driver, titanium set with hollow driver

Article	Content	REF
Mirapost Set 240, gold-plated	20 x 12 pcs.	355 975
Mirapost Set 120, titanium	20 x 6 pcs.	355 998
Mirapost Set 60, gold-plated	20 x 3 pcs.	355 974
Mirapost Set 60, titanium	20 x 3 pcs.	355 973

### Reamer

Article	∅	Content	REF
Mirapost Set 1 – 6		6 pcs.	355 997
Mirapost No. 1	1.05	3 pcs.	356 020
Mirapost No. 2	1.20	3 pcs.	356 021
Mirapost No. 3	1.35	3 pcs.	356 022
Mirapost No. 4	1.50	3 pcs.	356 023
Mirapost No. 5	1.65	3 pcs.	356 024
Mirapost No. 6	1.80	3 pcs.	356 025
Mirapost Hollow driver, separately			356 027
Mirapost Cross-type driver, separately			356 028

Gold-plated



Titanium

	S	M	L	XL
Reamer NF (Pack of 3)	(8 mm)	(9.5 mm)	(12 mm)	(14 mm)
<b>No. 6</b> (∅ 1.80) 356 025	G 355 981 Ti 356 004	G 355 987 Ti 356 010	G 355 993 Ti 356 016	G 355 995 Ti 356 018
<b>No. 5</b> (∅ 1.65) 356 024	G 355 980 Ti 356 003	G 355 986 Ti 356 009	G 355 992 Ti 356 015	
<b>No. 4</b> (∅ 1.50) 356 023	G 355 979 Ti 356 002	G 355 985 Ti 356 008	G 355 991 Ti 356 014	G 355 994 Ti 356 017
<b>No. 3</b> (∅ 1.35) 356 022	G 355 978 Ti 356 001	G 355 984 Ti 356 007	G 355 990 Ti 356 013	
<b>No. 2</b> (∅ 1.20) 356 021	G 355 977 Ti 356 000	G 355 983 Ti 356 006	G 355 989 Ti 356 012	
<b>No. 1</b> (∅ 1.05) 356 020	G 355 976 Ti 355 999	G 355 982 Ti 356 005	G 355 988 Ti 356 011	

**Refill packs available on request:  
6 titanium reamers or 12 gold-plated reamers.**



## Proto-Cam®

### Face shield



- No reflections, no distortions
- Very robust, durable polycarbonate
- Safe working
- Ultra-light design (only 28 g)
- Shield dimensions: 23 x 16.2 cm

Article	Content	REF
Proto-Cam	white frame, 5 shields, 1 headband	355 535
Proto-Cam, replacement shields	5 pcs.	355 536

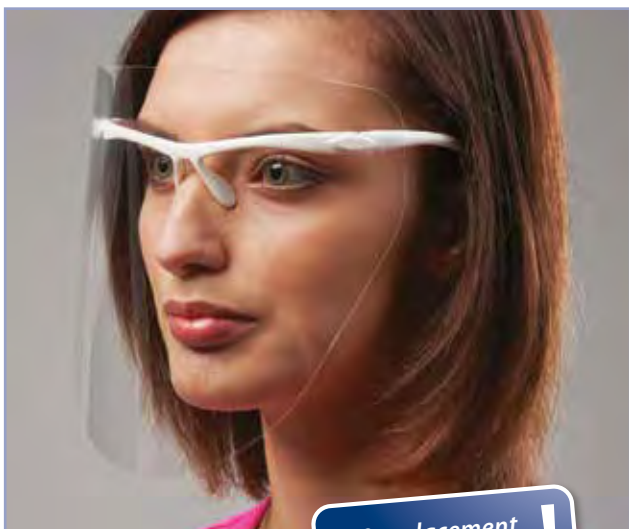

12 replacement shields INCLUDED !

## Proto-Cam® Smart

### Face shield



- Full facial coverage and protection
- High optical clarity
- Lightweight
- Sleek design
- Shield dimensions: 23.50 x 16.5 cm

Article	Content	REF
Proto-Cam Smart, white	1 frame with 12 shields	355 486
Proto-Cam Smart, blue	1 frame with 12 shields	355 485
Proto-Cam Smart, replacement shields	12 pcs.	355 484



## CC-Schild

### Face shield



- Highly impact-resistant and can be hinged upwards
- Fits any head size – adjustable Velcro fastening
- No light or color reflex
- For working in the laboratory, etc.
- Shield dimensions: 32.7 x 21 cm

Article	REF
CC-Shield	355 508



## Hager iSpec® Smart

### Safety glasses in classic design

- Ideal, ergonomic fit
- Unrestricted side vision
- Cost-effective

Frame	Lens	REF
Blue transparent	clear	355 665
Pink transparent	clear	355 666



23 g

## Hager iSpec® Full-vision safety glasses

### Full-coverage safety glasses

- Ideal for high-risk patients and as protection against airborne infections
- Tight, pressure-free fit (soft component directly connected to the lens)
- Very soft and lightweight textile headband for comfortable fit
- Good surround vision
- Very lightly tinted lens with blue light reduction
- Frame in black, white

Frame	Lens	REF
Black/white	tinted	355 629



34 g

## Hager iSpec® Lux

### Comfortable, modern safety glasses with LED light

- Mini-LED lamp\* is attached to the temple of the glasses and can be used as a reading aid or to illuminate a working area
- Perfect fit to any head shape
- Soft nose pad in x-design style
- Unrestricted side view
- Pressure-free fit thanks to elastic side temples

Frame	Lens	REF
White/anthracite	clear	355 667

Article	Content	REF
Hager iSpec Lux Mini-LED, Spare lamp incl. batteries	1 pcs.	355 668

\* Mini LED lamp is included with the purchase of the Hager iSpec Lux



24 g



30 g

## Hager iSpec® Softflex Fit

Innovative protective glasses optimally adjusting to any face

- Individually adjustable sides with multilevel inclination
- Excellent wearing comfort no matter the head size, due to integrated Softflex-zone
- Soft Softflex nosebridge offers comfortable, pressure-free fit and avoids annoying slipping
- Soft temples and Softflex-zone in the forehead area ensure a secure hold

Frame	Lens	REF
Anthrazit/blue	gray	355 613



37 g

## Hager iSpec® Sunshine Fit 2.0

Tinted eye wear with panoramic view

- Large panoramic lens with built-in side protection
- Lens with UV-400 protection, sun protection grade: 5 – 2.5
- Fog-free inside and scratch-resistant outside
- Perfect fit to any face shape
- Multi-stage adjustable temples
- Soft anti-slip temple tips prevent pressure points

Frame	Lens	REF
Orange/black	tinted	355 526



63 g

## Hager iSpec® Safety Fit

Original design and maximum safety

- All-around view
- Temple length and angle individually adjustable
- Pressure-free fit

Frame	Lens	REF
White	clear	355 518
Neck strap black		355 520



43 g



## Hager iSpec® Safety Fit II

Optimum eye coverage and large panorama lenses

- Variable side arm inclination (3 notches)
- Maximum wearer comfort for all face shapes due to flexible 2K side arms technology
- Optimal ventilation due to labyrinth seal
- Folds flat and fits into all pockets
- Coating: extremely scratch-resistant, inside anti-fog coating

Frame	Lens	REF
Blue	clear	355 624
Lime	clear	355 625



## Hager iSpec® anti-stress

### Safety glasses with a sporty design

- Blue light reduction up to 50 % (e.g. when using media, especially LED light sources)
- Ideal for precision work and in changing light conditions
- Fatigue-free and relaxed work
- Lens slightly tinted for better contrast and glare protection
- Unrestricted side view
- Pressure-free fit thanks to elastic temple ends

Frame	Lens	REF
White/anthrazit	tinted	355 669



## Hager iSpec® Pure Fit

### Trendy protective glasses with wide field of view

- Dual spherical protective glass offers ideal coverage of the eyes even in the area of the eyebrows
- Temple with integrated „climate-zone technology“ ensures you can work longer without fatigue
- High wearing comfort due to non-slip components
- Especially for slender faces: uvex Pheos small
- Coating: Outside extremely scratch-resistant, inside anti-fog coating

Frame	Lens	REF
Light gray/gray	clear	355 607
White/green (small)	clear	355 610
Anthrazit/gray (small)	clear	355 611



## Hager iSpec® Comfort Fit

### Fashionable multi-component protective eyewear

- High wearing comfort through hard/soft components
- Temple length individually adjustable
- Coating: outside extremely scratch-resistant, inside anti-fog coating
- Brown lens is chemical resistant



Frame	Lens	REF
White/black (no Anti-Fog)	brown	355 590
Blue/gray	clear	355 589





21 g

## Hager iSpec® Slim Fit UV

### UV protective eyewear

- Safe protection against UV radiation in extended wavelength range of 350 – 523 nm
- For all light polymerization units
- Tested by NIOM (Nordic Institute of Dental Materials)
- Coating: outside extremely scratch-resistant, inside mist-free

Frame	Lens	REF
White	orange	304 427



48 g

## Hager iSpec® BT Fit

### Extremely light and safe protective eyewear

- Fits over all prescription glasses
- Wrap-around lens with 180° field of vision
- Excellent, pressureless fit
- Efficient lateral ventilation
- New temple length and easy adjustment of inclination

Frame	Lens	REF
Trnsparent	clear	304 424



39 g

## Hager iSpec® Steril Fit OTG

### Lightweight overspecs

- Autoclavable glasses with anti-fog performance
- High comfort due to soft component
- Can be sterilized up to 10 times at 121 °C

Frame	Lens	REF
White/blue	clear	355 511



37 g

## Hager iSpec® Fit OTG

### Lightweihtg overspecs

- No contact of temples with the prescription glasses
- Good coverage of the eye area by flat basic curve
- Soft, extra flexible temple tips
- For ideal, visual image quality

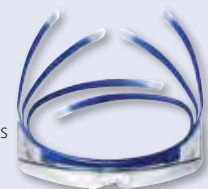

Frame	Lens	REF
Blue	clear	355 539



## Hager iSpec® Flexi Fit

Extremely lightweight protective glasses

- Excellent safety due to side protection
- Individually adjustable temple length

Frame	Lens	REF
Blue	clear	355 573
Replacement lens	clear	355 574



30 g

## Hager iSpec® Flexi Fit II

Flexible protective glasses

- High impact lens and frame
- Additional side protection against glare
- Length of soft temples individually adjustable
- Ideal for sports and leisure

Frame	Lens	REF
Blue	clear	355 580



38 g

## Hager iSpec® X Fit

Extreme light and modern safety glasses

- Anatomically shaped wrap-around lens
- Extreme wide peripheral and highly protected field of vision
- 20 % larger coverage versus regular temple glasses

Frame	Lens	REF
Black/anthrazit	clear	355 599



58 g

## Hager iSpec® Super Lite Fit

The world's lightest protective eyewear

- Flexible innovative temple technology
- X-Stream-Technology for highest wearing comfort and perfect fit
- Aerodynamically optimized and inclined lens geometry



Frame	Lens	REF
Crystal	clear	355 601
Navy blue	clear	355 602
Replacement lens	clear	355 603



18 g



## H&W Super Fit UV (OTG)

Over-the-glasses eyewear with large field of view

- Suitable for works with polymerization lamps (390-525 nm)
- Softpad technology assures ideal, ergonomic fit
- Unobstructed view to the sides
- Temple length adjustable

Article	REF
H&W Super Fit UV (OTG)	355 626



## H&W Classic

Stylish and comfortable protective eyewear

- Soft sides, adjustable with lock-in-place extension
- Provides full protection with 180° unobstructed view
- Anti-fog and anti-scratch clear lens with HC/AF coating
- 100 % impact resistant polycarbonate lens

Article	REF
H&W Classic	355 622



## H&W Panorama

Safety glass with panorama view and side protection

- Ergonomic temples
- Nose bridge of soft and anti-slip rubber
- Anti-fog and anti-scratch clear lens with HC/AF coating

Article	REF
H&W Panorama	355 620



## H&W Featherlight

Ultra-lightweight protective eyewear

- Soft temples with adjustable notches
- Adjustable soft nosepiece for a superior anti-slip fit
- Comfortable full wrap-around protection
- Anti-fog and anti-scratch clear lens with HC/AF coating
- Polycarbonate lens

Frame	Lens	REF
Pink/white	clear	355 661
White/green	clear	355 621



## H&W Panorama II

### For slender faces

- Ergonomic temples

Frame	Lens	REF
Transparent	clear	355 617



## H&W OTG II

### Panorama overspecs

- No contact of temples with the prescription glasses
- Good coverage of the eye area

Article	REF
H&W OTG II	355 618



## Hager iSpec® cleaning wipes

- Suitable for all spectacles
- The anti-fog and anti-scratch coatings remain unimpaired
- Thorough and streak-free cleaning
- Also suitable for face shields
- Individually wrapped (20 x 50 mm) and silicone free

Article	Content	REF
Hager iSpec cleaning wipes	100 pcs.	355 657



## Astro Clean®

### Spray disinfection

- Broad microbiological effectiveness
- Limited virucidal effect BVDV/(HCV), Vaccinia incl. HBV/HIV
- Suitable for use on most surfaces – dries quickly

Article	Content	REF
Astro Clean	250 ml	554 301





Hot Pink



Purple



## Hager Outbacks

### Protection and elegance at work

- Modern polishing techniques reduce distortions
- Fog reduction is the effect of a special ventilation system
- Light weight frame prevents pressure on head and ears
- Silicone nose piece prevents sliding
- Silicone grips on temples
- Each pair includes a free neck strap (black)

Frame	Lens	REF
Black	clear	304 702
Hot Pink	clear	304 703
Purple	clear	304 705
Blue	clear	304 706
Neck strap black, separately		304 711



Blue



Black



## H&W Kids Protect

### Ergonomic protective eyewear for children

- Most helpful protection in treatment for children aged 4 – 10
- Comfortable and child-friendly fit
- Easily adapts to slender-headed forms
- Lightweight 17 g

Article	REF
H&W Kids Protect	355 635



## Miramask® FFP2

### Respiratory mask

- 4-layer respiratory protection with inserted, adjustable nose clip
- Soft and elastic ear tape
- Fits well under the chin
- Particularly breathable
- Ideal for eyeglass wearer
- Water-repellent and latex free
- EN 149:2001 + A1:2009

Article	Content	REF
Miramask FFP2	5 pcs.	605 499
Miramask FFP2	40 pcs.	605 502
Miramask FFP2	500 pcs.	605 503



## Miramask® FFP3

### Respiratory mask

- 4-layer respiratory protection with soft, adjustable nose clip
- Highest possible protection: filtration efficiency:  $\geq 99\%$
- High wearing comfort
- Ideal for wearer of glasses
- Water-repellent and latex free

Article	Content	REF
Miramask FFP3	50 pcs.	605 469



## Miramask®

### Disposable mask made of lightweight fleece material

- Hygienic and very good value for money
- No proven protective effect

Article	Content	REF
Miramask	100 pcs.	605 412





## Toothbrushing Model

### Enlarged demonstration model

- For demonstration of the correct brushing technique
- With oversized toothbrush
- Ideal for motivation of children



Article	REF
Toothbrushing Model incl. super-brush	355 636
Toothbrushing Model Super-brush separately	355 637

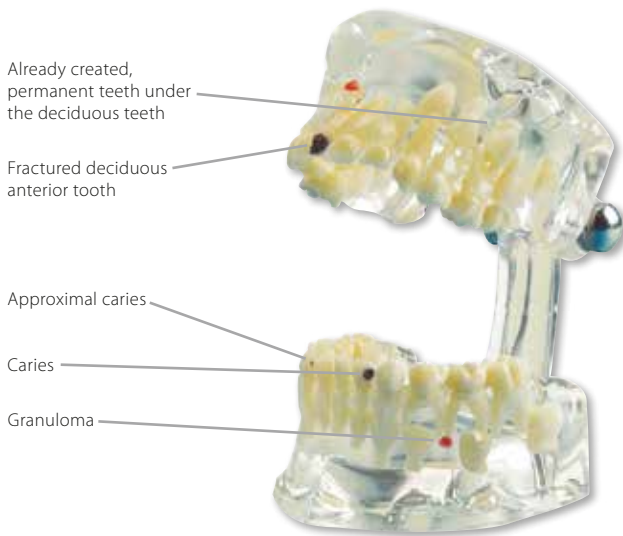

## Study Model Transparent Child

### Demonstration model Child

- Very clear illustration of deciduous and permanent teeth
- Maxilla and mandible with ten deciduous teeth
- With broken deciduous front tooth with root disease
- Scale 1:1

Article	REF
Study Model Transparent Child	355 643
Study Model Transparent Child de Luxe (without tooth decay, not illustrated)	355 651



## Study Model Demo Implant C+B

### Transparent demonstration model of various prosthetic works

- Demonstration of various in-/onlays and implant works
- 11 removable works for patient information
- Made of solid and transparent polymer material
- Scale 1:1

Article	REF
Study Model Demo Implant C+B	355 638
Replacement restorations (11 pcs.)	355 639



Three-unit bridge (Molar)



Three-unit bridge (Front tooth)

## Study Model Transparent De Luxe

### Demonstration model adult with tooth diseases

- Maxilla and mandible feature various of tooth defects, courses of carious defects malocclusion of lower wisdom teeth
- Several examples of inflammatory root processes
- Illustration of an implant work with build-up
- Teeth not removable, scale 1:1



## Study Model Transparent Plus

- Demonstration of various tooth defects and courses of carious defects
- Teeth not removable
- Scale 1:1

Article	REF
Study Model Transparent Plus	355 640
Study Model Transparent De Luxe	355 642

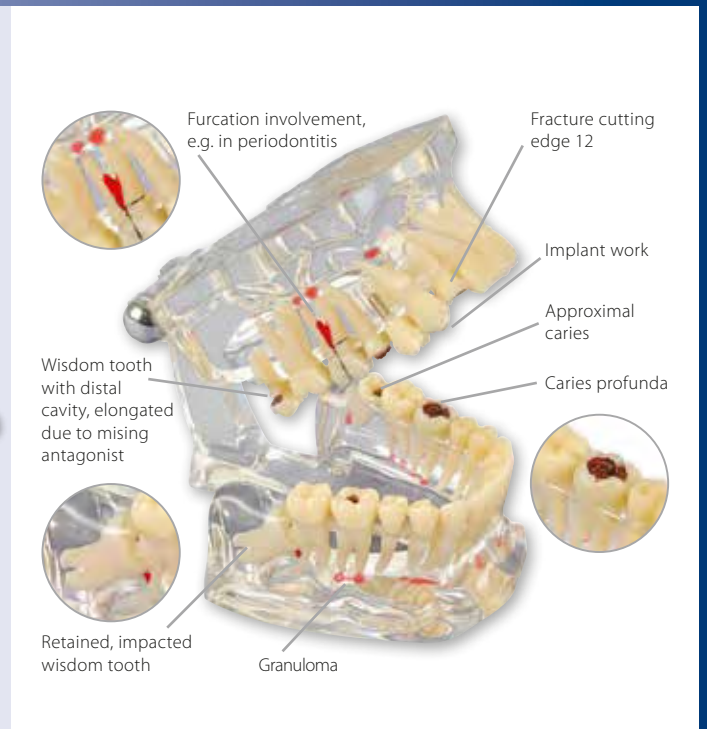

## Study Model Transparent

### High-quality transparent demonstration model

- All 32 teeth can be removed from the alveole
- Well visible root anatomy
- Made of transparent, solid plastic
- Scale 1:1

Article	REF
Study Model Transparent	355 641



## Mira-Duo

### Double-sided patient mirror

- Front 1:1, back twofold magnification
- ø 13 cm
- Can be used as hand or table mirror
- Ideal for control – especially in prophylaxis

Article	REF
Mira-Duo	605 682

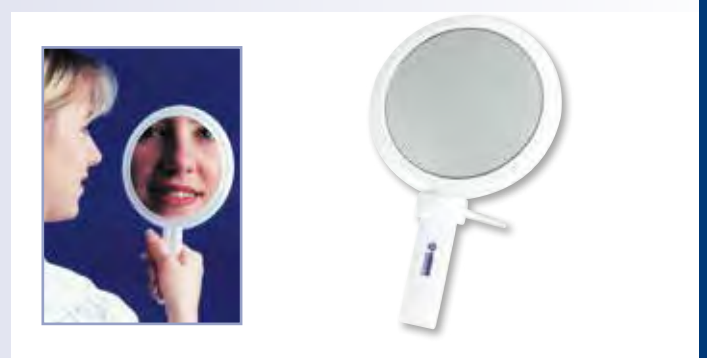

## McTooth Mirror

### Molar-shaped pop-up mirror

- For prophylaxis in children and adults
- Size approx. 17 x 14 cm

Article	REF
McTooth Mirror	707 094





Medium (W x H x D):  
8.5 x 2.2 x 9 cm

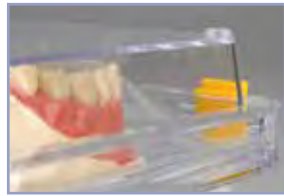

Small (W x H x D):  
4 x 1.9 x 4 cm



XXL (W x H x D):  
19.2 x 4.8 x 9.2 cm

## Membranbox Medium

### Patented transport and storage box

- With two elastic, transparent membranes
- Ideal storage to safely send pieces of high-quality work
- Long durability due to high-quality material
- Stackable

Article	REF
Membranbox Medium: for bridges, partial dentures, attachments, etc.	304 602

## Membranbox Small and XXL

### Transport and storage box with inside membranes

- Two membrane foils hold the contents gently and well visible
- Safety lock
- No rattling due to two membrane foils gently holding even smallest pieces
- Stackable

Article	REF
Membranbox Small: set with 12 pcs. for crowns, inlays, etc.	304 603
Membranbox XXL: for 2 models	304 605



Dento-Box I: height 2.5 cm



## Dento-Box® I + II

### Solid transport and storage box

- For prosthesis, orthodontic works, retainer, etc.
- Impact-proof, safe snap lock and small ventilation holes
- Can be customized with your name and logo (from 500 pcs.)
- Available in two different heights

Article		Content	REF
Dento-Box I, white	●	12 pcs.	355 148
Dento-Box I, blue	●	12 pcs.	355 149
Dento-Box I, pink	●	12 pcs.	355 150
Dento-Box I, light green	●	12 pcs.	355 151
Dento-Box I, violet	●	12 pcs.	355 152
Dento-Box I, glittery silver (not illustrated)	●	12 pcs.	355 153
Dento-Box II, white	●	10 pcs.	355 141
Dento-Box II, blue	●	10 pcs.	355 142
Dento-Box II, pink	●	10 pcs.	355 143



Dento-Box II: height 4 cm



Dento-Box with cord can be found on page 98 in our miradent assortment.

## Putzi-Pets

### Hand puppets with denture

- The ideal aid to motivate children
- For explanation of appropriate dental care
- Special effect: With the small water bottle, the puppets turn into water pistols
- Dimensions (W x H x D): approx. 17 x 28 x 15 cm

Article		REF
Putzi Croc	(1)	707 045
Putzi Dino	(2)	707 046
Putzi Cow	(3)	707 047
Putzi Horse	(4)	707 048
Putzi Dragon	(5)	707 092
Putzi Tiger	(6)	707 093



(1)

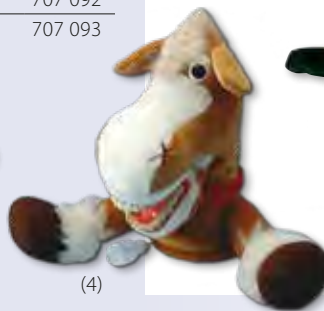

(4)



(2)

(3)



(5)



(6)



## Putzi-Buddys

### Big hand puppets with denture

- Dimensions (W x H x D): approx. 25 x 38 x 18 cm

Article		REF
Putzi Cow Berta		707 081
Putzi Teddy Bear		707 083
Putzi Horse Jimmy		707 084



## Miratoi® No. 1

### Mixed assortment

- Cars, boats, combs etc.

Article	Content	REF
Miratoi No. 1, assorted	150 pcs.	605 690





## Miratoi® No. 3

### Farm Set

• Various farm animals



Article	Content	REF
Miratoi No. 3, assorted	100 pcs.	605 692



## Miratoi® No. 4

### Zoo Set

• Various zoo animals



Article	Content	REF
Miratoi No. 4, assorted	100 pcs.	605 693



## Miratoi® No. 6

### Finger rings

• Lovely finger rings in various sizes



Article	Content	REF
Miratoi No. 6, assorted	100 pcs.	605 694



## Miratoi® No. 7

### Watches

• Puzzle in the shape of watches in various colors



Article	Content	REF
Miratoi No. 7, assorted	80 pcs.	605 695





## Miratoi® No. 8

### Bouncy balls

- Funny bouncy balls in various colors
- ø 2.5 cm



Article	Content	REF
Miratoi No. 8, assorted	100 pcs.	605 696

## Miratoi® No. 10

### Miniature cars and boats

Miniature cars and boats in various colors



Article	Content	REF
Miratoi No. 10, assorted	100 pcs.	605 698

## Miratoi® No. 12 + No. 21

### Medal set

- Special award as motivation for brave young patients
- Stamped medal with ribbon
- Made of plastic



No. 12



No. 21



#### Miratoi No. 12: Package with 50 medals and 50 certificates

Article	Content	REF
Miratoi No. 12 (medal Ø 3.9 cm)	50 pcs.	605 706
Miratoi No. 21 (medal Ø 3.6 cm, no certificates)	50 pcs.	605 731

Certificates in different languages available on request:

GER - GB - F - E - IT - NL - HR - SRB - MK - P

## Miratoi® No. 13

### Treasure chests

- Ideal for the safekeeping of deciduous teeth



Article	Content	REF
Miratoi No. 13, assorted	100 pcs.	605 699



## Miratoi® No. 15

### Mini ponies

- For combing and cuddling
- In five colors



Article	Content	REF
Miratoi No. 15, assorted	50 pcs.	605 701



## Miratoi® No. 17

### Fingerboards

- Ultimate fingerboards in five cool designs



Article	Content	REF
Miratoi No. 17, assorted	50 pcs.	605 707

## Miratoi® No. 19

### Snap-on bracelets

- Reflecting bracelets increase the visibility in the dark
- Snap-on bracelets automatically bend under slight pressure and adjust to any wrist girth
- Well suited for cyclists and joggers
- Size (L x W): 21 x 2.5 cm



Article	Content	REF
Miratoi No. 19	50 pcs.	605 702

## Miratoi® No. 20

### Glider for brave patients

- Glider made of polystyrene
- 5 different versions
- Glides through the air effortlessly, with propeller for good flying characteristics
- Unsuitable for children younger than 3 years of age, use only under adult supervision



Article	Content	REF
Miratoi No. 20, assorted	50 pcs.	605 704

## Miratoi® No. 22

### Unicorn pearl bracelets

- Decorative bracelets with pearls (Ø 7 mm)
- With unicorn pendant
- Elastic band

Article	Content	REF
Miratoi No. 22, assorted	50 pcs. (30 x rose, 20 x white)	605 741



## Tooth Coin Bank

### Tooth-shaped coin bank

- Solid ceramic-like material
- Large opening, also suitable for bills
- With reclosable opening at the bottom



Article	REF
Tooth Coin Bank	707 105



## Anti-Stress Tooth

### Effective relaxation aid

- By squeezing the tooth, the patient gets pleasantly distracted
- Ideal for stress relaxation or as a gift
- Dimensions: 64 x 54 x 38.5 mm, weight: 42 g
- Material: polyurethane



Article	REF
Anti-Stress Tooth	707 002



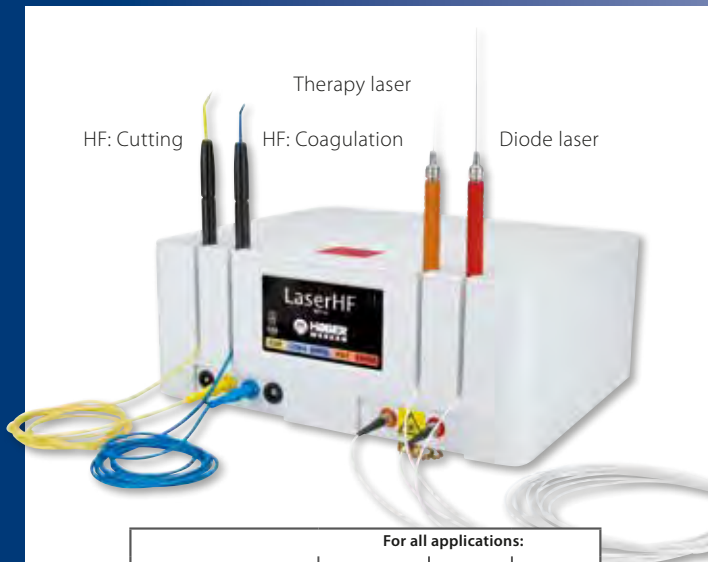

	For all applications:		
	Laser	HF	LaserHF
Oral surgery	●	●	●
Periodontology	●	●	●
Implantology	●	●	●
Endodontics	●	●	●
Bleaching	●	●	●
aPDT	●	●	●
LLLT	●	●	●

**Radio Frequency Surgery:  
Optimal Cutting and Coagulation**

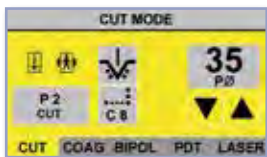

Cutting



Coagulation

**Diode laser 975 nm/8 W: Therapeutic Laser:  
Parodontology, Endo-  
dontie and more**

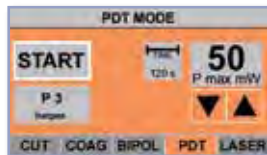
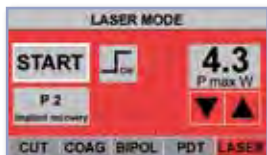

Exposure



Endodontics



Frenectom



Herpes

**LaserHF®**

**Laser and HF technology combination device**

- I-Cube design with touch screen control
- Preset programs for all possible applications
- Individual control available additionally
- Highest possible functionality and hygiene
- Touch screen monitor for easy operation and selection of programs

**LASER:**

- Disinfection and cleaning of gingival pockets in periodontosis
- Disinfection after root canal preparation in endodontics
- Removal of soft tissue, e.g. in implant surgery in peri-implantitis
- Wound healing, pain relief and desensitisation by Low Level Laser Therapy (LLLT)
- PDT laser (photodynamic therapy)
- Optionally: accelerated bleaching by laser therapy

**RADIO FREQUENCY:**

- Two hand pieces working independently of each other for exchangeable electrodes (color-coded): cutting- and cutting-/coagulation wave (yellow), coagulation wave (blue)
- All type of treatments are possible due to the three forms of frequency: Cutting, cutting with coagulation for haemostasis, coagulation, pulse-driven coagulation to gently weld small tissue pieces
- Automatic voltage control
- hf Bipolar forceps optionally available
- Hand piece and electrodes are autoclavable at 134 °C

**Technical data:**

HF power max. 50 W  
 HF frequency 2.2 MHz  
 Laser PDT: 660 nm/100 mW  
 Laser 975 nm/8 W – cw/pulsed  
 Dimensions (W x H x D): 30 x 13 x 25 cm  
 Power supply: 230V/50Hz  
 HF 2.2 MHz/50 W – monopolar/bipolar  
 Weight: approx. 3.5 kg



**Basic equipment:**

- 2 laser hand pieces (red for 8 W laser, orange for softlaser)
- 1 x fiber tip 200 µm + 1 x fiber tip 320 µm
- Safety glasses Lambda One (800 – 975 nm)
- Over-spec Skyline (green, 800 – 975 nm)
- Over-spec Skyline (blue, 657 – 660 nm)
- Patient's safety glasses
- 2 HF hand pieces (autoclavable)
- Set of electrodes (No. 40, 2, 13, 15, 31, 33)
- Neutral electrode, door contact/interlock, foot pedal
- Instructions for use, medical product journal

hf Bipolar Forceps to be ordered separately!

**The standard LaserHF device is still available.**

Article	REF
LaserHF Standard with 2.5 m glass fiber	452 462
hf Bipolar-Forceps see page 71	



LLLT



aPDT

## LaserDUO

### Laser device

- Preset programs for all possible applications
- Plus individual programming
- Highest possible functionality and hygiene
- Touch screen monitor allows for easy operation and selection of programs

**LASER:** For features see LaserHF page 68

#### Technical data:

Power supply: 230 V / 50 Hz

Laser PDT: 660 nm / 100 mW

Laser 975 nm: 8 W – cw/pulsed

Dimensions (W x H x D): 21 x 12 x 25 cm, weight: 2.3 kg

Article	REF
LaserDUO Standard (bare fibers)	452 485



## LaserHF® PDT Solutions

### PDT-solution for disinfection

- Photo-activated disinfection of root canals, periodontal pockets and for treatment of peri-implantitis
- For Laser 660 nm, Fiber 320 µm

Article	Content	REF
LaserHF PDT Solutions	3 syringes à 1.2 ml	155 031



## Mirawhite® Laser Bleaching

### Dental bleaching gel for use with diode laser

- Bleaching gel adapted for wave lengths
- For diode lasers 810 – 980 nm
- Two component bleaching gel in a 5 g mixing cartridge
- With 35 % hydrogen peroxide concentration for highly effective bleaching and brightening of vital and devital teeth

(When using in combination with the LaserHF device, the bleaching gel gets activated with the special LaserHF bleaching hand piece (REF 452 472).

**Set consists of:** 1 bleaching-gel cartridge with 35 % hydrogen peroxide 5 g, 3 mixing tips, 1 syringe with ginigiva protector 1 ml, 1 syringe with afterbleach care 2 ml, 2 applicators

Article	REF
Mirawhite Laser Bleaching	607 086



Before

After



## Hager iSpec Laser safety glasses

- (1) Laser safety glasses yellow: protection grade LB4, for laser 808 – 1064 nm\*, 27 g
- (2) Laser overspecs yellow: overspecs with the same properties, 51 g
- (3) Laser overspecs blue: overspecs for diode soft laser 650 – 660 nm\*, 51 g
- (4) Glasses for patients: broadband protection with special metal inserts

Article	REF
(1) Laser protective glasses, yellow	355 630
(2) Laser overspecs, yellow	355 631
(3) Laser overspecs, blue	355 632
(4) Laser glasses for patients	355 633



\* All of our glasses are LaserHF compatible. Should you use another laser, please calculate the safety grades your laser requires and compare them with the information stated on the laser safety glasses, before using them.

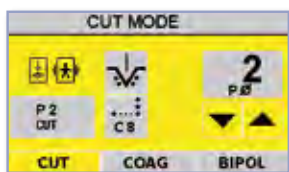

Source: Prof. Dr. med. Frank Liebaug

## hf1 Surg bipolar

### Universal HF surgery device

- Preset programs for all possible applications
- Additionally offers individual programming
- Standard fitting: connection for bipolar forceps
- Highest possible functionality and hygiene
- Touch screen monitor for easy operation and program selection
- Two individually working hand pieces for exchangeable electrodes (color marked): cutting and cutting/coagulation wave (yellow), coagulation wave (blue)
- Every application is possible due to three frequency forms: cutting, cutting with coagulation for haemostasis, coagulation, pulsed coagulation for gentle welding of smaller tissue particles
- Automatic voltage regulation
- Bipolar forceps (not included in scope of delivery)
- Hand piece and electrodes are autoclavable at 134 °C

#### Scope of delivery:

Device with 2 autoclavable hand pieces, foot pedal, set of electrodes (6 pieces: Nos. 40, 2, 15, 13, 31, 33), neutral electrode

hf Bipolar Forceps to be ordered separately!

#### Frequency and power:

2.2 MHz, max. 50 W  
Voltage: 230 V/50 Hz  
Unipolar and bipolar  
Permanent/pulsed

#### Dimensions and weights:

W x H x D: 21.5 x 11.7 x 25 cm  
Weight: 2.65 kg

Article	REF
hf1 Surg bipolar	452 459

Optional: hf Bipolar-Forceps and cable (recommended), see page 71

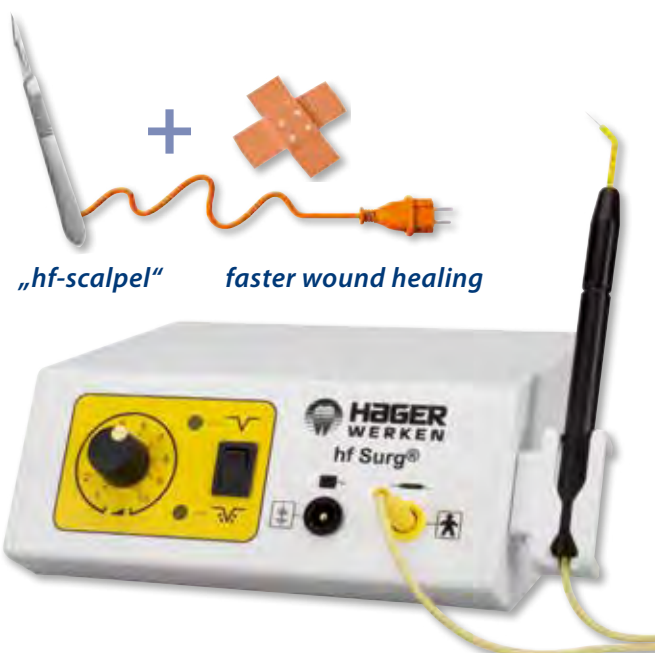

„hf-scalpel“

faster wound healing

## hf Surg®

### Low priced and sophisticated radio surgery unit

- For scalpell fine, pressureless incisions- frequency control enables cut and cut/coagulation for haemostasis
- Fast and painless wound healing
- Highest possible functionality and hygiene
- Easy handling of the analog intensity control and frequency switch
- Automatic output management, fail safe mechanism when in contact with metal
- Hand piece and electrodes are autoclavable at 134 °C

#### Scope of delivery:

Device with foot pedal, hand piece, 4 electrodes and neutral electrode

hf Bipolar-Forceps to be ordered separately!

#### Frequency and power:

2.2 MHz, max. 50 W  
Voltage: 230 V/50 Hz

#### Dimensions and weights:

W x H x D: 19 x 9 x 18 cm  
Weight: approx. 1.6 kg

Article	REF
hf Surg	452 400

## hf Electrodes

Article	REF
hf cutting electrode No. 1, yellow	452 403
hf cutting electrode No. 2, yellow	452 404
hf cutting electrode No. 12, yellow	452 410
hf cutting electrode No. 13, yellow	452 411
hf cutting electrode No. 14, yellow	452 409
hf cutting electrode No. 15, yellow	452 407
hf cutting electrode No. 17, yellow	452 405
hf cutting electrode No. 22, yellow	452 406
hf cutting electrode No. 23, yellow	452 408
hf coagulation electrode No. 31, blue	452 415
hf coagulation electrode No. 33, blue	452 416

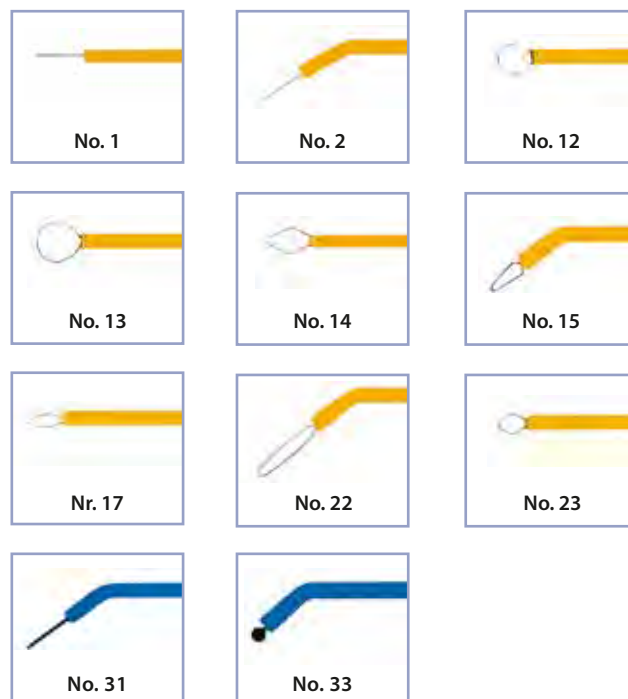

## hf Bipolar-Forceps

Special forceps connection for the hf Surg devices

- Available in two lengths and shapes, without cable
- Can be sterilized
- Ideal for surgical dentists, e.g. in achieving hemostasis

**Please note:** For first equipping, the hf Bipolar cable needs to be ordered separately. Not included in the scope of delivery.

Article	Form of Delivery	REF
hf Bipolar-Forceps	110 mm straight	452 446
hf Bipolar-Forceps	110 mm angulated	452 447
hf Bipolar-Forceps	160 mm straight	452 448
hf Bipolar-Forceps	160 mm angulated	452 455
Cable for Bipolar-Forceps	1.50 m	452 456



## hf Neutral Electrode

Coated earth plate for optimal conduction of the hf waves

- Disinfectable

Article	REF
hf Neutral Electrode, length 1.50 m	452 421

If reorder please mention the serial number of your old appliance!



## LaserHF® Curver/ LaserHF® Fiber Cutter

Article	REF
LaserHF Curver bending tool	452 480
LaserHF Faser Cutter, ceramic knife	452 481

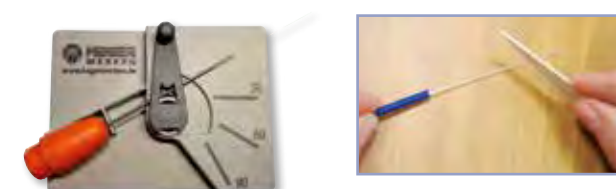



## Algimix

### Alginat mixing device

- Reliable, solid stainless steel body, maintenance-free
- Minimal time exposure
- Electronically controlled, even stirring movement mixes powder and liquid to an absolutely homogeneous bubble-free alginate mass
- High-quality, durable mixing bowl made of flexible silicone
- Stirring speed adjustable in two levels

#### Technical data:

Voltage:	230 V
Power consumption:	100 W
Fuse:	1.25 A
Dimension incl. bowl (W x H x D):	13.5 x 23 x 20 cm
Weight with (without) bowl:	3.7 kg (3.5 kg)

Article	REF
Algimix with bowl and spatula	452 045
Spatula only	304 317



## Praxipol PS II

### Pressure polymerization vessel

- Approx. 6 l content
- For hot and cold polymerization
- Incl. inlet valve, pressure gauge and safety valve (GS-TUV-approved)
- Nonstick layer inside to avoid corrosion

Article	REF
Praxipol PS II	401 450
Additional hose with coupling, 2 m	401 401



## Mirator® 2000E

### Electronically adjustable vibrator

- Continuously variable to up to 6,000 vibrations/min.
- Sturdy and powerful
- Worktop available separately upon request

#### Technical data:

Worktop:	13 x 15 cm
Voltage:	230 V – 50/60 Hz
Power consumption:	max. 200 W
Safety fuse:	1 A
Weight:	3.5 kg

Article	REF
Mirator 2000E	401 350



## Bravo Portable II

### Strong portable micro motor

- Allows working without wallsocket, ideal for home visits
- Infinitely variable motor with back- and forward-running (0 – 25,000 rpm)
- Rechargeable, long-lasting battery recharging time six hours, up to eight hours pure working time
- Suitable for any standard hand and contra-angles piece with plane shaft (not included in delivery) without intra-spray and without light conductor
- Can be attached to the belt, space-saving

Article	REF
Bravo Portable II with belt bag and recharger	452 102

Straight and contra-angle handpieces can be found on page 104.



## Bravo Portable II Plus

### Powerful, portable micromotor

- No need for a power socket, ideal for home visits
- Infinitely variable motor with forward and reverse rotation (0 – 30,000 rpm)
- Rechargeable, long-lasting battery, charging time 3 hours, up to 8 hours pure working time
- Suitable for any standard hand and contra-angle piece with plane shaft (not included in delivery) without intra-spray and without light conductor
- Can be attached to the belt, space-saving

Article	REF
Bravo Portable II Plus incl. clip, handpiece tray, charger, and foot pedal	452 125



## Speedo-Clean

### Silent Denture cleaning device

- Esthetic surface cleaning using rotating polishing needles in combination with a cleansing liquid – no material abrasion
- Integrated timer allows for individual cleaning times
- Additional magnet keeps the needles in the container when replacing the liquid
- Autoclavable container

#### Technical data:

Weight: 2 kg      Frequency: 50/60 Hz  
 Output: 35 W      Rotation: 1,700 U/min  
 Voltage: 230 V

Article	REF
Speedo-Clean with container, 50 g polishing needles (ø 0.6 mm) 1 liter of liquid and 1 magnet	401 136
50 g polishing needles, nickel-free stainless steel ø 0.6 mm for dentures	304 014
Speedo-Clean Liquid, 1 liter	554 106
Container with lid (to collect the needles)	355 419
Magnet separately	304 012





## Speed Labolight®

### Universal light polymerization device

- For all light-curing dental materials
- Nanometer spectrum 320 – 550 nm
- Optimized light mixture for a homogenous and safe curing
- Circular arrangement of eight rod-shaped lamps around a turntable (dia. 14 cm) and one halogen lamp
- Interval turntable for an evenly light impact and curing
- Adjustable from one second to 99 minutes, protection against overheating, polymerization temperature in the chamber does not exceed 40 °C
- Durable (approx. 1,000 hours), easy-to-exchange lamps
- Acoustic signal indicates end of polymerization
- Operating hours counter

#### Technical data:

Supply voltage:	230 V, 50 Hz	<b>Size and weight:</b>
Power consumption:	225 W	(W x H x D): 25 x 29 x 24 cm
Fuse:	1 x 2.5 A	Weight: 7 kg
Lamps:	8 x 9 W T1 (white light)	Turntable: ø 14 cm
	4 x 9 W T8 (UV-A)	
	1 x 150 W (halogen)	

Article	REF
Speed Labolight unit incl. 13 lamps	401 125

#### Separate single lamp

Article	REF
T1 (white light) 9W/71	901 002
T8 (UV-A) 9W/PLS-10	901 003
Halogen	901 004
Set (4 x T1 and T8, 1 x halogen each)	901 001



## Glas Bead Heater

### Device for heating up instruments

- Ideal to obtain anti-fog effect with mouth mirrors or instrument prior to treatment
- Not suitable for sterilization
- Special heating element warms glass beads up to 230 °C and keeps the temperature constant without heating the outer body of the device
- Removable chamber, easy cleaning
- Dimensions (W x H x D): 14 x 13 x 19 cm, chamber ø 5 cm

Article	REF
Glas Bead Heater incl. 200 g glas beads	452 303
Glass bead refill pack, 200 g	452 304



## Airsonic® Mini Sandblaster

### Handy sandblaster

- For roughening of bonding surfaces of crowns, bridges, brackets, posts, etc.
- Thoroughly roughened bonding surfaces for optimal bonding of various materials
- Ideal for all metals and ceramics
- Also suitable for the removal of cement residues from crowns and bridges

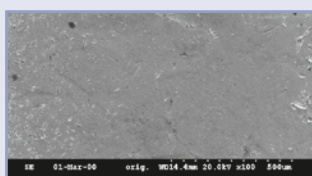

before sandblasting

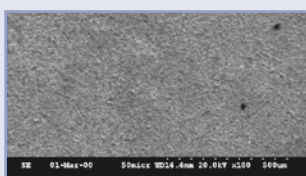

after sandblasting

Article	REF
Sandblaster, standard nozzle 60° and 20 g powder (50 µm)	401 080
Nozzle 60° separately	401 086



## Airsonic® Adapters

Article	REF
a) Adapter K for direct connecting to Kavo turbine	401 084
b) Adapter S for direct connecting to Sirona titan turbine	401 089
c) Connection to W+H Rotoquick	401 077
d) Bien Air Unifix	401 076
e) Connection to EMS-Box	401 090
f) Connection to lab coupling	401 091
g) Adapter for direct connecting to NSK	401 075

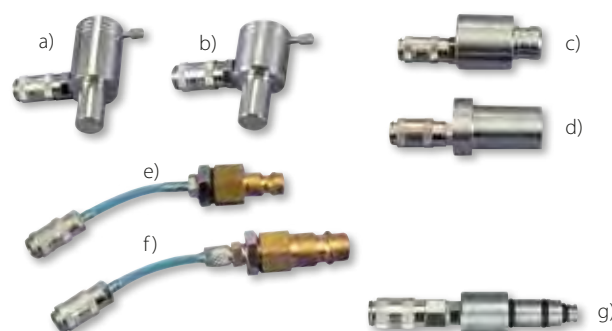

## Airsonic® Absorbo Box®

### Handy absorber box

- Portable absorber box – the abraded material remains in the box and is completely collected in the filter
- Very low-noise and high-performance device
- Solid and durable design
- Problem-free cleaning by removable filter
- No separate aspiration system required
- Ideal for practice and practice laboratory in combination with the Airsonic mini sandblaster (REF 401 080)

#### Technical Data:

Dimensions (W x H x D): 35.6 x 22 x 37 cm

Weight: only 2.8 kg

Equipment available on request.

Article	REF
Airsonic Absorbo Box	401 082
Replacement filter separately	401 092
Replacement pane available on request	



## Airsonic® Alu-Oxyd

### AL<sub>2</sub>O<sub>3</sub> powder for sandblasting

Article	Content	REF
Airsonic Alu-Oxide, 50 µm	500 g	605 084
Airsonic Alu-Oxide, 90 µm	500 g	605 086



## Blue-Flame 1500

### Handy burner for dental practice and laboratory

- Easy, practical one-hand operation
- Reliable ignition
- Solid freestanding burner, 15 cm only
- Flame temperature infinitely variable from approx. 800 – 1,300 °C, max. burning time approx. 35 minutes
- Refillable with APT gas (not included in scope of delivery)

Article	REF
Blue-Flame 1500	401 006



## APT III Burner

### Convenient burner with one-hand operation

- Activation of ignition without having to put the instrument down
- Extra reliable ignition system
- Infinitely variable flame
- Transport securing
- Refillable with APT gas (not included in scope of delivery)

Article	REF
APT III Burner	401 001



## Kisag Burner

### Gas burner for dental practice and laboratory

- Flame temperature infinitely variable from approx. 750 – 1,150 °C
- One filling for a burning time of 5 – 6 hours
- With the Swiss SVGW sign (equivalent to the German GS sign)
- Refill with Kisag gas only

Article	REF
Kisag Burner incl. 400 ml Kisag Gas	401 005
Kisag Gas, 400 ml	605 140

## Miratorch®

### Inexpensive dental burner for dentist and laboratory

- Small, handy burner (170 g)
- Easy adjustment and control of temperature and flame, infinitely variable
- Burning temperature 1,300 °C
- Burning time approx. 60 – 70 minutes
- Refillable with APT gas (not included in scope of delivery)

Article	REF
Miratorch	401 010



## APT Gas

### Refill gas

- With various adapter tips to refill APT, Miratorch and Blue Flame burners, etc.

Article	Content	REF
APT Gas	200 ml	605 143



## Miracast

### Model former

- With vertical retention marks inside
- Inexpensive, in three sizes

Article	Size	REF
Miracast UK small	80 x 60 x 15 mm	203 066
Miracast UK medium	85 x 65 x 15 mm	203 067
Miracast OK small	75 x 60 x 15 mm	203 065
Miracast OK medium	80 x 61 x 15 mm	203 068
Miracast OK large, fits for upper and lower impressions	100 x 80 x 15 mm	203 069





Integra Cart Smart



back



Integra Cart De Luxe II



back



Delivery without device



## Integra® Cart Smart

### Low priced model

- Two universal electrical sockets
- Trays with rim protection
- Maximum load per tray 10 kg
- With spiral cable power connection
- Color: white (RAL 9003)



**Dimensions (W x H x D):** 35 x 78 x 45 cm **Weight:** 14.5 kg

Article	REF
Integra Cart Smart	460 120

## Integra® Cart De Luxe II

### Multifunctional cart

- With compressed air supply
- Two universal electrical sockets
- Upper tray with additional material drawer
- With spiral cable power connection
- Easy-running castor wheels
- Lockable front castors

**Dimensions (W x H x D):** 77 x 35 x 45.5 cm **Weight:** 17.8 kg

Article	REF
Integra Cart De Luxe II	460 116
Integra Cart De Luxe III (Not illustrated, with 2 drawers, 3 sockets, 21.4 kg)	460 117

## Integra® Cart Fit-On Tray

### Tray for the column of surgery lamp

- Suitable for all accessory devices (e. g. hf1 Surg bipolar), which are needed chairside
- Rotatable by two swivel-joints
- Handle mountable on long or short side
- Elegant and easy to mount on all columns
- Solid metal tray, max. load 6 kg, color: off-white (RAL 9002)

**Dimensions:** Outside (W x D): 35 x 26 cm, Inside (W x D): 33.5 x 24.5 cm  
Swivel arm: 23 cm long

Article	REF
Integra Cart Fit-On Tray with standard arm	460 103

**The Fit-On Tray has to be ordered together with the fitting pipe flange to allow for mounting.**

Pipe flange incl. internal ring	ø	REF
For Planmeca	42 mm	460 104
For Ritter	48 mm	460 106
For Eurodent	50 mm	460 107
For Sirona/Siemens	52 mm	460 108
For Kavo/Flex Integral	55 mm	460 109
For Ultradent/Faro	60 mm	460 110
For other units	45 mm	460 105

\* not for Sirona Teneo/Sinus – available on request



# Wellbeing for your back



1 Standard

also available →



2 Cutaway -  
Particularly narrow curvature

also available →



3 Small -  
Smallest saddle shape for  
those with a small frame

also available →



4 Large -  
Largest saddle shape for  
those of a larger build

- >> Preserves the natural pelvic and spinal position when sitting
- >> Significantly reduces the pressure on the intervertebral discs
- >> **Tilt angle** and height of the seat adjustable



# Ergotherapeutic Seat

## Small

- Particularly popular with people with a small frame

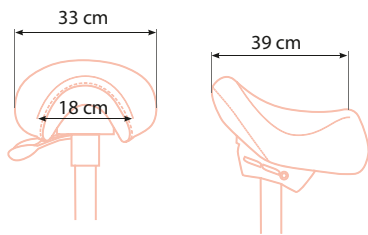

Extra **SMALL** saddle shape!



## Large

- Particularly popular with people of a larger build

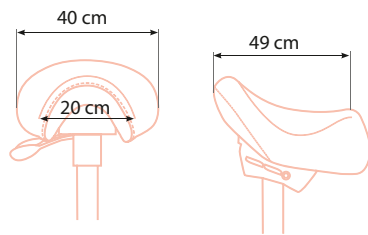

Extra **LARGE** saddle shape!



## Cutaway

- Comfortable for people with narrow hips

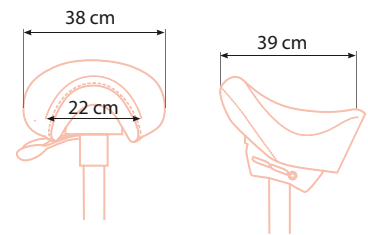

With **NARROW** curvature!



Article	Color	REF
Bambach Small, genuine leather	Black	B205051
Bambach Large, genuine leather	Black	B207051
Bambach Cutaway, genuine leather	Black	B204051
Bambach Cutaway, med. grade vinyl	Black	B203001

Seat height ideally matched to the appropriate body size – please consider when placing an order. Height of gaslifts:  
 S up to 1.60 m    M up to 1.90 m    L over 1.90 m

## Wide range of colors (Medical Grade Vinyl)

White #012	Almond #011	Silver Pearl #008	Pink #014	Sunshine #009	Ruby #017
Lagoon #015	Stone #006	Grey #003	Baltic #002	Aubergine #013	Blue Heron #004
	<b>Genuine leather</b> upon request				
Black #001					





## POSTURE matters:

Unhealthy C-shaped posture

Healthy S-shaped posture

*„The natural sitting position pleases! You sit much straighter. We have noted a substantial improvement of our back problems and the pain associated with them. We would never want to be without the seat.“*  
(Dr. med. Helga Heß, Hinternah, Germany)

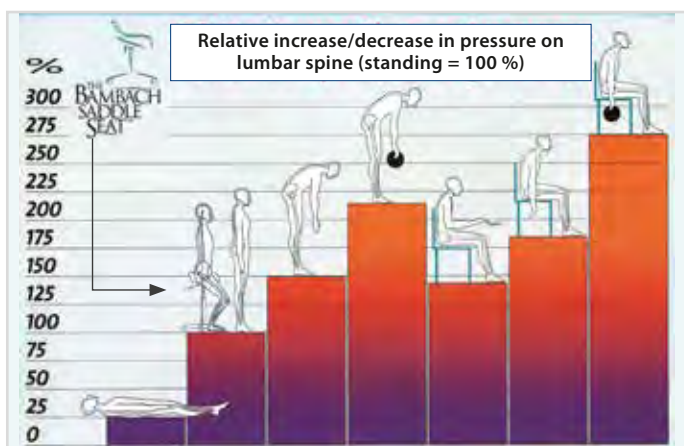

### THE PROBLEM

Conventional seats force the spine into an unhealthy “C” shape. This unnatural posture increases the pressure on your spinal discs to an alarming extent, which can result in many problems, mainly in combination with pain in the back, neck, arms, hands or shoulders.

### THE SOLUTION

Thanks to its patented back curvature, the BAMBACH Saddle Seat is the only seat that ideally supports your pelvis, allowing your spine to keep its natural “S” shape. While this avoids a poor sitting posture, you benefit from a natural, healthy posture.



Video

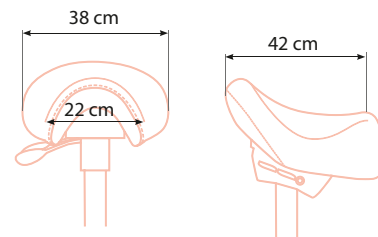

## Standard

- Standard saddle shape
- Particularly popular among people with hips of average width
- Ensures a healthy and comfortable posture
- For the elimination and prevention of back pain

### Seat height ideally matched to the appropriate body size:

Height of gaslifts	S	M	L
Body size	up to 1.60 m	up to 1.90 m	over 1.90 m

(Please consider when placing an order)

### Article

Bestseller: BAMBACH Saddle Seat Standard Black





## Bambach® OP

### Seat particularly for operation theatres

- In correspondence with the hygienic guidelines in operation theatres
- Can be completely disinfected
- Height can be adjusted hygienically, leaving your hands free
- Foot height adjuster
- Top with adjustable tilt angle
- Back pain prevention and elimination
- Top made of polyethylene
- Cradle, gas lift and base made of stainless steel

Article	Color	REF
Bambach OP	black	460 100



## Bambach® Foot Height Adjuster

### Foot operated height adjuster

- Sitting height can be adjusted in an easy and hygienic way, leaving (your) hands free
- Quick change of position
- Perfect for surgeries and long treatments
- Stainless steel
- Suitable for gas lift (stems) large and medium

Article	REF
Foot height adjuster large	901 239
Foot height adjuster medium	901 245

**Our recommendation!**



## Bambach® Leather Care Oil

Content	REF
50 ml	554 304



## Bambach® Seat Cover

### Hygienic protection for Bambach Saddle Seats

- Protection & hygiene
- With elastic seams
- Breathable material

Article	Content	REF
Bambach Seat Cover, white	50 pcs.	605 253



## Bambach® Backrest Smart

- Fully disinfectable
- Height adjustable
- Dimensions 22 x 15 cm



**Article**  
Bambach Backrest Smart



**REF**  
BBKR-1001

## Bambach® Armrest Smart

Relief during longer treatments

- Perfect for endodontics and dental surgery
- Relieves tension in the shoulder muscles
- Swivel-mounted armrest
- Length 55 cm
- Available in black vinyl only



Article	REF
Bambach Armrest Smart, mounted on the right	BARM-1901
Bambach Armrest Smart, mounted on the left	BARM-3901

## Bambach® Armrest

Relief during longer treatments

- Ideal for longer treatments such as endodontics and surgeries
- Relief for the shoulder muscles
- Can be swiveled and retrofitted
- In two versions:
- Armrest short (Length 30 cm)
- Armrest long (Length 55 cm)



Article	REF
Armrest long, Penuine leather black, 55 cm (right)	BARM-1051
Armrest long, genuine leather black, 55 cm (left)	BARM-3051
Armrest short, genuine leather black, 30 cm (right)	BARM-2051
Armrest short, genuine leather black, 30 cm (left)	BARM-4051

## Bambach® Armrest Microscope

With three movable arm axes

- Armrest freely movable in width and length (free-swinging)
- Height adjustable (fixed)
- Relieves shoulder, neck and arms



(Double armrest)

Article	REF
Bambach Armrest Microscope	BARM-6000



## Xylitol Chewing Gum

### Sugar-free chewing gum with xylitol

- 100 % sweetened with xylitol
- Free of aspartame, sorbitol, lactose
- Contributes to tooth mineralization\*
- Reduces the risk of tooth decay in children\*\*\*
- Reduces plaque\*\*
- Promotion acrylic display available on request

#### Reclosable tube with 30 gums/30 g

Article	Content	REF
Xylitol Chewing Gum, Spearmint	30 pcs.	630 079
Xylitol Chewing Gum, Peppermint	30 pcs.	630 080
Xylitol Chewing Gum, Cranberry	30 pcs.	630 090
Xylitol Chewing Gum, Fresh Fruit	30 pcs.	630 082
Xylitol Chewing Gum, Cinnamon	30 pcs.	630 081
Xylitol Chewing Gum, Watermelon	30 pcs.	630 225
Xylitol Chewing Gum, Green Tea	30 pcs.	630 091
Xylitol Chewing Gum, Apple	30 pcs.	630 192
Xylitol Chewing Gum, Strawberry	30 pcs.	630 193
Xylitol Chewing Gum, Display, assorted	6 x 12 tubes	635 092

#### Dispenser box with 200 packs of 2 dragées each

Article	Content	REF
Xylitol Chewing Gum, assorted	200 pcs.	635 069

#### Bag of 100 pieces of 2 dragées individually packed

Article	Content	REF
Xylitol Chewing Gum, Spearmint	100 pcs.	630 114
Xylitol Chewing Gum, Peppermint	100 pcs.	630 088
Xylitol Chewing Gum, Cranberry	100 pcs.	630 116
Xylitol Chewing Gum, Fresh Fruit	100 pcs.	630 089
Xylitol Chewing Gum, Cinnamon	100 pcs.	630 115
Xylitol Chewing Gum, Watermelon	100 pcs.	630 227
Xylitol Chewing Gum, Apple	100 pcs.	630 235
Xylitol Chewing Gum, Strawberry	100 pcs.	630 236

Article	Content	REF
Economy package Spearmint	200 pcs.	630 300
Economy package Fresh Fruit	200 pcs.	630 301
Economy package Peppermint	200 pcs.	630 302
Economy package Cinnamon	200 pcs.	630 303

\* The positive effect occurs when chewing the xylitol chewing gum for at least 20 minutes after eating or drinking. (Consuming food that contains xylitol instead of sugar helps maintain tooth mineralization.)  
 \*\* Chewing gum, which is sweetened 100% with xylitol, has been proven to reduce dental plaque. Heavy plaque is a risk factor for the development of tooth decay in children. The positive effect is ensued if 2 – 3 g of chewing gum – 100% sweetened with xylitol – are consumed at least 3 times a day after meals.  
 Notes: Chewing gum with sweetener. Excessive consumption may have laxative effects! Please pay attention to a balanced and varied diet and a healthy lifestyle. Recommended daily allowance: Adults 1 – 10 pieces. Not for children under three years (risk of suffocation if swallowed). Life-threatening for pets.

**For nutritional information see page 98**

## From the practice for the practice



Dear Dental Practitioners, our miradent products are available through the dental dealers, but also in pharmacy, so interested patients can easily purchase them. Of course, the miradent products also represent an ideal complement to the range of your prophylaxis shop. Detailed information on our products can also be found here: [www.miradent.de](http://www.miradent.de)

### XyliPOP®

#### Sugar-free lollipop with sweeteners

- With xylitol and calcium lactate
- Contributes to tooth mineralization\*
- Free of aspartame, sorbitol, lactose
- Also great for adults
- Fruity-refreshing strawberry, blueberry or banana flavor

Article	Content	REF
XyliPOP Strawberry, 6 g		630 208
XyliPOP Strawberry, Bonboniere	25 x 6 g	635 213
XyliPOP Strawberry, Box	50 x 6 g	635 214
XyliPOP Blueberry, 6 g		630 219
XyliPOP Blueberry, Bonboniere	25 x 6 g	635 236
XyliPOP Blueberry, Box	50 x 6 g	635 231
XyliPOP Banana, 6 g		630 230
XyliPOP Banana, Bonboniere	25 x 6 g	635 252
XyliPOP Banana, Box	50 x 6 g	635 251

\* Consuming food that contains xylitol instead of sugar helps maintain tooth mineralization. Please pay attention to a balanced and varied diet and a healthy lifestyle. Notes: Excessive consumption may have laxative effects. Not for children under three years (risk of suffocation if swallowed). Life-threatening for pets.



### Xylitol Powder

#### For sweetening of cold and hot drinks, fruit, cereals or for baking

- Ideal for a balanced and healthy diet
- Same sweetening effect as sugar
- 40 % fewer calories than sugar
- 100 % natural sweetness
- GMO-free
- From renewable raw materials
- Packaging made of recycled material



Article	Content	REF
Xylitol Powder	350 g	630 119
Xylitol Powder	100 x 4 g	630 120
Xylitol Powder	5 x 350 g	635 080
Xylitol Powder	1 kg	630 228

Excessive consumption may produce laxative effects.





Cherry Melon Mint



## Xylitol Drops

### Sugar-free drops with sweeteners

- Sweetened with xylitol
- Contributes to tooth mineralization\*
- Free of aspartame, sorbitol, lactose
- Free of gluten
- Cool, refreshing flavor

Article	Content	REF
Xylitol Drops, Melon	60 g/26 pcs.	630 170
Xylitol Drops, Cherry	60 g/26 pcs.	630 171
Xylitol Drops, Mint	60 g/26 pcs.	630 172

### Dispenser box with 100 drops – individually packed

Article	Content	REF
Xylitol Drops, assorted	100 Drops	635 183



## AQUAMED® Lozenges

## AQUAMED® Spray

### For the support of saliva production

- Contributes to tooth mineralization\*
- Sweetened with xylitol
- Refreshing passion fruit flavor

Article	Content	REF
AQUAMED Lozenges	60 g/26 pcs.	630 164
AQUAMED display	10 x 60 g	635 207
AQUAMED Spray	30 ml	630 218
AQUAMED Spray display (not shown)	12 x 30 ml	635 218
AQUAMED combi-display	6 x Lozenges, 6 x Spray	635 222



## AQUAMED® Chewing Gum

### Dental care chewing gum

- Helps to reduce dry mouth\*
- Reduces the risk of tooth decay in children \*\*
- Contributes to tooth mineralization\*\*\*
- Reduces plaque\*\*
- Refreshing passion fruit flavor

Article	Content	REF
AQUAMED Chewing Gum	30 pcs./30 g	630 223
AQUAMED Chewing Gum display	12 tubes à 30 pcs./30 g	635 230

\* The positive effect is ensued if the chewing gum is consumed every time your mouth feels dry.  
 \*\* Chewing gum, which is sweetened 100% with xylitol, has been proven to reduce dental plaque. Heavy plaque is a risk factor for the development of tooth decay in children. The positive effect is ensued if 2 – 3 g of chewing gum – 100 % sweetened with xylitol – are consumed at least 3 times a day after meals.  
 \*\*\* The positive effect occurs when chewing the xylitol chewing gum for at least 20 minutes after eating or drinking. (Consuming food that contains xylitol instead of sugar helps maintain tooth mineralization.) Notes: Chewing gum with sweetener. Excessive consumption may have laxative effects! Please pay attention to a balanced and varied diet and a healthy lifestyle. Recommended daily allowance: Adults 1 – 10 pieces. Not for children under three years (risk of suffocation if swallowed). Life-threatening for pets.



## Carebrush® white

### Toothbrush with „whitening effect“

- Brush head with special rubber lamellas cleans thoroughly, while also having a natural tooth whitening effect
- Spiral-shaped bristles at the front of the brush head optimize access to difficult-to-reach areas
- Criss-cross bristles support thorough cleaning of interdental spaces
- Anatomic „anti-slip“ handle



Article	REF
Carebrush white, green	630 190
Carebrush white, pink	630 191

## Carebrush® supersoft

### Toothbrush with silky-soft micro bristles

- Silky-soft bristles for hypersensitive teeth necks and irritated gums (e.g. in periodontitis) and for dental care following prophylaxis treatments
- Gentle and thorough cleaning with low enamel abrasion
- Tongue scraper at back of the brush head
- Anti-slip handle



Article	REF
Carebrush supersoft	630 195

## Carebrush® ortho

### Toothbrush with v-shaped bristle system for the cleaning of fixed braces

- For the cleaning of brackets and other orthodontic works
- V-shaped bristle field for an effective cleaning of brackets
- Soft inner bristles and harder outer bristles
- Long and narrow neck to simplify access to hard-to-reach areas



V-form



Article	REF
Carebrush ortho	630 196

## Happy Morning® De Luxe

### Toothbrush with even bristle field

- Rounded bristles and angled handle
- Bristle size medium, separately packed

Article	Content	REF
Happy Morning De Luxe	50 pcs.	605 443





## Happy Morning® Disposable toothbrush

- Ideal for brushing teeth in the dental practice before treatment, on short trips, etc.
- Hygienically and separately packed



Article	Content	REF
Happy Morning, impregnated with toothpaste	100 pcs.	605 401
Happy Morning, without toothpaste	100 pcs.	605 403



## Happy Morning® Xylitol Disposable toothbrush with xylitol

- Bristles are impregnated with xylitol toothpaste
- Fresh flavor
- Short head design (2.5 cm)
- Hygienically and separately packed
- Ideal when traveling, in between meals and as toothbrush for guests
- Xylitol has an anti-cariogenic effect, decreases plaque- and acid-forming bacteria

Article	Content	REF
Happy Morning Xylitol	50 pcs.	605 496



## Happy Morning® Bamboo Disposable toothbrush made of bamboo

- Handle made from 100 % biodegradable, sustainably grown bamboo
- Bamboo acts antibacterial and germ-reducing
- Bristles are impregnated with xylitol toothpaste
- Short head design (2.5 cm)
- Individually, hygienically packed in biodegradable film

Article	Content	REF
Happy Morning Bamboo	40 pcs.	605 426



## Happy Morning® Travel Kit Dental care travel kit companion

- Toothbrush and 3 g tube with fresh mint toothpaste
- Toothbrush and tube hygienically blister-packed as set
- Toothbrushes in five colors, assorted, 5 x 10 pcs.

Article	Content	REF
Happy Morning Travel Kit	5 x 10 pcs.	605 410



## paroguard®

### Patient-friendly mouth rinse solution

- Remineralizing due to fluoride (250 ppm)
- Ideal for patients with limited oral hygiene
- Astringent due to hamamelis
- Anti-cariogenous due to Xylitol
- Alcohol-free

Article	Content	REF
paroguard	200 ml	630 087

### Size with advantage 5 liters

- Optionally available with dosing pump (1 push = 10 ml)

Article	Content	REF
paroguard (pump not included)	5000 ml	630 127
Pump dispenser		630 138



## mirafleur® chx

### Mouth rinsing solution with chx 0.06 %

- For daily use, incl. dosing cap
- Remineralizing due to fluoride (250 ppm)
- Astringent due to hamamelis
- Anti-cariogenous due to xylitol
- Alcohol-free
- Support of daily mouth care due to chlorhexidine gluconate (0.06 %)

Article	Content	REF
mirafleur chx	100 ml	630 085
mirafleur chx	500 ml	630 086



## SOS Zahnbox®

### Rescue box for dental accidents

- Transport box for knocked-out teeth and tooth fragments
- Safe and clean way to store a knocked-out tooth or tooth fragment
- Special nutrient solution increases the chance of successful replantation
- Maintaining a concentration gradient - cells of the periodontal ligament (desmodontium) remain intact until replantation

Article	Content	REF
SOS Zahnbox		631 040
SOS Zahnbox display	6 pcs.	635 115





Toothpaste with fluoride



Fluoride enrichment can prevent plaque



Mentha Arvensis – field mint

## Mirafleur® C

### High-quality fluoride toothpaste

- Fine abrasive silica particles
- Mild mint flavor
- Xylitol and sodium fluoride (1,450 ppm)

Article	Content	REF
Mirafleur C	100 ml	630 083



Open dentinal tubuli cause irritation reactions



Closed dentinal tubuli

● Potassium ions ● Hydroxyapatite

## mirasensitive hap<sup>+</sup>

### Intensive care for the preservation of sensitive teeth

- Sealing of open tubules
- 30 % hydroxyapatite builds up biomimetic enamel
- Potassium ions calm the tooth nerve
- Daily treatment to protect teeth from painful stimuli
- Contains fluoride and Xylitol to prevent tooth decay and tooth neck decay
- Mild and fresh taste
- RDA-value: 30
- Sodium fluoride (1,450 ppm)

Article	Content	REF
mirasensitive hap <sup>+</sup>	50 ml	630 169
mirasensitive hap <sup>+</sup> display	8 pack.	635 191



Child-friendly, rice grain-sized dosage possible



## Mirafleur® Kids

### Toothpaste for children (0 – 6 years)

- Cleans milk teeth and gums
- Protection against tooth decay with fluoride and Xylitol
- Special tube opening protects against increased fluoride absorption
- Refreshing raspberry flavor
- Xylitol and sodium fluoride (1,000 ppm)

Article	Content	REF
Mirafleur Kids	75 ml	630 224

## Mirawhite® gelée

### Intensive cleaning for shiny white teeth

- Immediate illuminating effect
- Restores natural tooth whiteness
- Innovative multiple-effectiveness
- Xylitol and sodium fluoride (1,450 ppm) prevent tooth decay

Article	Content	REF
Mirawhite gelée	100 ml	630 123
Mirawhite gelée display	8 pack.	635 097_GB



## Mirawhite® shine

### Effective tooth whitening even in sensitive teeth

- Pen for hygienic application
- Tooth whitening with active-oxygen
- Free of peroxide
- Gentle on enamel and gingiva
- Does not soften fillings
- Tooth whitening by up to five shades
- Period application 7 – 14 days, twice a day



Article	Content	REF
Mirawhite shine	1.8 ml	630 194
Mirawhite shine display	6 pack.	635 212



## XYLIMED® Nasal spray + drops

### Xylitol active formula with mineral salt

- Fast relief
- Non-habit forming
- Only natural ingredients

Article	Content	REF
XYLIMED Nasal spray	45 ml	630 184
XYLIMED Nasal drops for children	22 ml	630 185





## OXYSAFE® Active<sup>+F</sup>

### Mouthwash with active oxygen

- Preventive and supportive treatment of periodontitis and peri-implantitis
- Protects against tooth decay
- Reduces plaque
- Strengthens the gingiva
- Strengthens the enamel
- For extra white teeth
- Fights bacteria
- Freshens your breath
- Contains sodium fluoride (450 ppm)

Article	Content	REF
OXYSAFE Active <sup>+F</sup>	500 ml	630 311

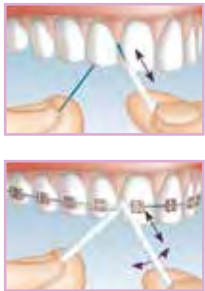

## Mirafloss® Implant

### Floss fibers from the roll

- Floss fibers (15 cm each) rolled up in a handy dispenser
- Stiff ends facilitate threading
- Ideal for the cleaning of implants and bridges
- Available in two thicknesses: fine (ø 1.8 mm), medium (ø 2.2 mm)

Article	Content	REF
Mirafloss Implant, pink, fine	45 pcs.	630 187
Mirafloss Implant, turquoise, medium	20 pcs.	630 188



## Mirafloss® Big

### Wall-mountable dispensing box

- Ideal for professional use in practice
- One-handed operation using sharp metal edge
- Refillable

Article	Content	REF
Mirafloss Big (white, waxed/black, waxed, mint)	2 x 200 m	605 735
Mirafloss Big refill: black, waxed, mint	200 m	605 737
Mirafloss Big refill white, waxed	200 m	605 736
Mirafloss Big refill: white, unwaxed	200 m	605 738

## Mirafloss®

### Dental floss/tape

- For specially thorough cleaning of interdental spaces
- Extremely tear-proof, does not fray
- Tape: not waxed, but consisting of PTFE, glides perfectly through even the narrowest interdental spaces

Article	Content	REF
Mirafloss Tape	20 m	630 022
Mirafloss Tape unwaxed	20 m	630 077



## Zahnpick®

### Convenient combination of dental floss and toothpick



- 30 pcs.: handy resealable box, 100 pcs.: separately blister-packed

Article	Content	REF
Zahnpick, Box	30 pcs.	630 039
Zahnpick, separately blister-packed	100 pcs.	605 637



Resealable box



## I-Prox® L

### Interdental brush in pocket size

- Lengthened L-shaped handle and 100° angle facilitate handling
- Hygienic protective cap
- Ideal on the go
- Six sizes from xx-fine – large, color-coded

Design		Ø Coated wire		Cleaning cylinder
<b>pink</b> xx-fine		Ø 0.4 mm		Ø 1.8 mm
<b>yellow</b> x-fine		Ø 0.5 mm		Ø 2.0 mm
<b>white</b> fine		Ø 0.6 mm		Ø 2.5 mm
<b>green</b> medium		Ø 0.7 mm		Ø 3.5 mm
<b>orange</b> conical		Ø 0.8 mm		Ø 2.5 – 5.0 mm
<b>bordeaux</b> large		Ø 0.8 mm		Ø 5.0 mm

Article	Content	REF
I-Prox L, pink, xx-fine	6 pcs.	630 210
I-Prox L, yellow, x-fine	6 pcs.	630 211
I-Prox L, white, fine	6 pcs.	630 212
I-Prox L, green, medium	6 pcs.	630 213
I-Prox L, orange, conical	6 pcs.	630 214
I-Prox L, bordeaux, large	6 pcs.	630 215
I-Prox L, assorted	6 pcs.	630 216





## Pic-Brush® Set

### Interdental brush holder with one brush

- Connector system with conical neck for a safe fit
- Ergonomically shaped handle with 120° angle
- Flexible high-quality brushes, coated special wire, ultra-fine bristles
- Protection against injuries due to elaborate loop technique of wire end
- Holder end with storage compartment and clip-on function
- Also for cleaning of brackets, bridges and dentures

Article	Color	REF
Pic-Brush Set, holder with 1 brush	blue transparent	631 002
Pic-Brush Set, holder with 1 brush	pink transparent	631 003
Pic-Brush Set, holder with 1 brush	yellow	605 630
Pic-Brush Set, holder with 1 brush	dark blue	630 001

## Pic-Brush® Intro Kit

### Interdental brush holder with four brushes in four thicknesses

Article	Color	REF
Pic-Brush Intro Kit, holder with 4 brushes	blue transparent	630 005
Pic-Brush Intro Kit, holder with 4 brushes	pink transparent	630 006
Pic-Brush Intro Kit, holder with 4 brushes	yellow	605 728
Pic-Brush Intro Kit, holder with 4 brushes	dark blue	630 004

Design		Ø Coated wire	Cleaning cylinder	
<b>pink</b> xx-fine		ø 0.45 mm		ø 1.6 mm
<b>yellow</b> x-fine		ø 0.5 mm		ø 1.8 mm
<b>white</b> fine		ø 0.6 mm		ø 2.0 mm
<b>green</b> medium		ø 0.8 mm		ø 2.2 mm
<b>blue</b> large		ø 0.8 mm		ø 3.0 mm
<b>bordeaux</b> x-large		ø 0.8 mm		ø 6.5 mm
<b>orange</b> conical		ø 0.5 mm		ø 2.5 - 5.0 mm

## Pic-Brush® Replacement Brushes

### In practical hygienic storage box



Article	6 pcs.	12 pcs.	25 pcs.
Pink, xx-fine	630 013	605 748	607 060
Yellow, x-fine	630 014	605 713	607 061
White, fine	630 015	605 722	607 062
Green, medium	630 016	605 631	607 063
Blue, large	630 017	605 632	607 064
Bordeaux, x-large	630 050	605 789	607 065
Orange, conical	630 018	605 711	607 066
Assorted		605 633	

## I-Prox® P

### Pointed brush for precise use

- Efficient cleaning of gingival border and gingival pockets with tapered bristle tuft
- Ideal for the cleaning of orthodontic appliances, implants and interdental spaces
- Optimal application of preparations
- Finger-grip handle (14 cm) with two click-on angles (60° and 120°)
- Holder end with storage compartment for brushes



Gingival pocket      Implants      Brackets

Article	REF
I-Prox P, holder blue transparent incl. 4 tips	630 032
I-Prox P, holder pink transparent incl. 4 tips	630 033
I-Prox P, replacement brushes, 4 pcs.	630 034

**Switch-function**  
allows for two angles  
for various applications

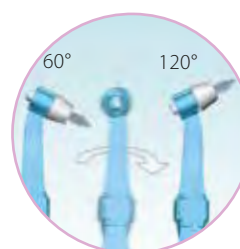
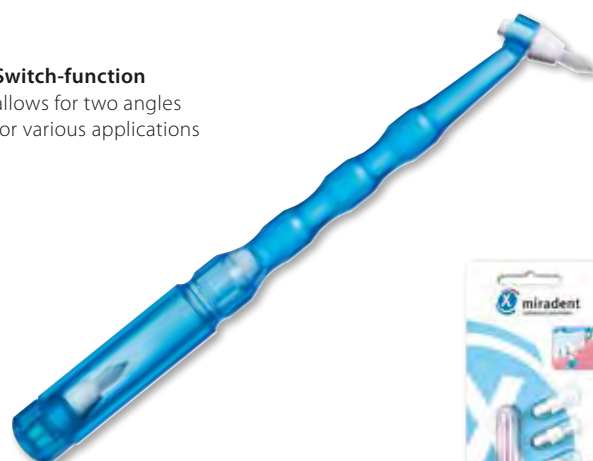

## I-Prox® Care Set

### Interdental care set

- For efficient cleaning of sulcus, interdental spaces and bridges
- Finger-grip handle allows for safe and precise use
- Holder end of sulcus brush with storage compartment for replacement brushes
- Anti-fog coated mouth mirror for immediate self control
- I-Prox C for persistent adherences, double-ended

**Set includes:**

miradent mouth mirror, I-Prox C (double-ended toothscaler/cleaner), I-Prox P Sulcus brush

Article	REF
I-Prox Care Set, blue transparent	630 160



## miradent® Mouth Mirror

### Disposable plastic anti-fog mouth mirror

- Flat angulated mirror head reaches all regions in the mouth
- Anti-fog coating
- Ergonomic finger form handle
- For domestic tooth control
- Diameter 23 mm/no. 5

Article	REF
miradent Mouth Mirror, blue transparent	630 065

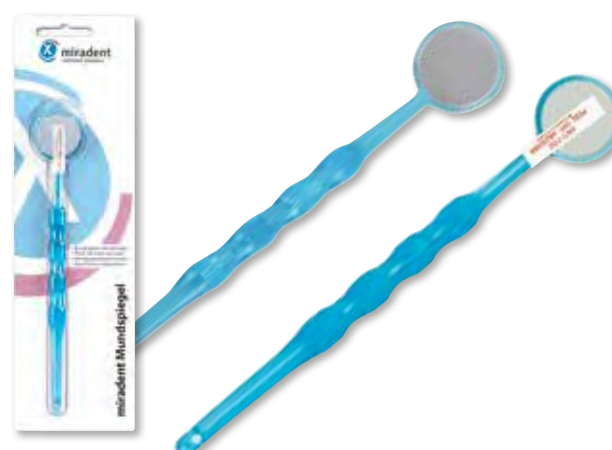

For mouth mirrors in practical economy pack see page 24.



Disclosing makes the PTC up to 3 times more effective !

## Mira-2-Ton®

### Plaque disclosing

- Older plaque is revealed in blue, newer plaque in pink
- Proven in the dental practice for years
- Motivating quality control for dental assistant and patient
- Erythrosine- and gluten-free
- Discolorations can be removed by brushing teeth

## Mira-2-Ton® Solution

### Plaque disclosing solution

Article	Content	REF
Mira-2-Ton solution	10 ml	605 659
Mira-2-Ton solution display	12 x 10 ml	605 660
Mira-2-Ton solution	60 ml	605 655
Mira-2-Ton Pellets (see page 38)	250 pcs.	605 662

## Mira-2-Ton® Tablets

### Plaque test tablets

Article	Content	REF
Mira-2-Ton Tablets	6 pcs.	630 027
Mira-2-Ton Tablets	5 x 10 pcs.	605 765
Mira-2-Ton Tablets	250 pcs. (loose)	605 768
Mouth Mirror (ø 23 mm) separately	blue transp.	630 065
Mira-2-Ton Tablets display	16 pack.	635 027

## Plaque Check

- Contains three plaque test tablets and one mouth mirror (with anti-fog coating) for self-control

Article	REF
Plaque Check with blue mirror	630 044

## halitosis spray

### Oral care spray for immediate fresh breath

- Eliminates mouth odor (halitosis)
- Dental care properties due to added Xylitol (10 %)
- Alcohol-free

Article	Content	REF
halitosis spray	15 ml	630 168
halitosis spray display	12 sprays	AK-1203GB



## Tong-Clin® De Luxe

### Tongue cleaner

- Dual function in one instrument:
  - Bristle field with short, rounded bristles lifts off tongue coatings
  - Tongue scraper removes the loosened coatings subsequently
- Angled, flat arched top reduces gag reflex
- Ergonomic finger-grip handle with protective cap

Article	REF
Tong-Clin De Luxe, blue transparent	630 029
Tong-Clin De Luxe, pink transparent	630 030
Tong-Clin De Luxe, blue	605 778



## Tong-Clin® Gel

### Tongue cleaning gel with a gentle and nurturing cleaning effect

- Removes tongue coatings gently
- Nurtures with camomile, sage and calendula
- Long-lasting feeling of freshness
- Alcohol-free

Article	Content	REF
Tong-Clin Gel	50 ml	630 059
Tong-Clin Set	Tong-Clin + 50 ml Gel	630 060
Tong-Clin Fresh	Tong-Clin + 15 ml Gel	630 179
Tong-Clin Fresh display	14 pack.	635 198



## Protho Brush® De Luxe

### Prosthesis brush

- With two brush heads: large brush field for cleansing of outer prosthesis surfaces and smaller brush field for the hard-to-reach inner sides
- Ergonomically shaped finger form-grip handle

Article	REF
Protho Brush De Luxe, blue transparent	630 024
Protho Brush De Luxe, pink transparent	630 025
Protho Brush De Luxe, dark blue	605 413



## Protho Box

### Waterproof, lockable prosthesis box

- For storage and cleaning of prosthesis
- Waterproof due to special locking
- Holds 2 prostheses and approx. 80 ml of liquid
- Also suitable for storage of removable braces
- Box contains double-sided cleaning brush, white bristles for basic surfaces, black bristles for prostheses indentations
- Brush compartment also for cleaning tablets
- With mirror in the lid

Article	REF
Protho Box incl. brush	605 900
Brush separately	605 901



Dimensions (W x H x D):  
11.5 x 4.5 x 8.5 cm



**Bristle field**

For a gentle massage of the gums and cleaning of the first milk teeth.



**Teething ring**

The handle, which also acts as a teething ring, promotes tooth eruption with the special nubs.

## Infant-O-Brush®

### Learner's toothbrush integrated in a teething ring

- Teaches regular dental care in a playful way
- Teething ring with extra soft bristle field
- Nubs enhance dentition
- Oval shape eliminates risk of swallowing and injury
- For infants from 3 months of age

Article	REF
Infant-O-Brush, red	630 026
Infant-O-Brush, yellow	605 617



## miradent® Hourglass

### Child-appropriate hourglass as timer for tooth brushing

- Ideal for observing the recommended minimum brushing time
- Running time: 2 minutes
- With suction cup, attachable to any smooth surface

Article	REF
miradent Hourglass	630 068



For Dento-Box without hang cord see page 62

## Dento-Box® I

### Solid transport and storage box

- For prosthesis, orthodontic works, etc.
- Impact-proof, safe snap lock and small ventilation holes
- With trendy hang cord

Article	REF
Dento-Box I, white	630 162
Dento-Box I, blue	630 161
Dento-Box I, pink	630 163



## Xylitol Chewing Gum

### Product description see page 84

**INGREDIENTS SPEARMINT, PEPPERMINT AND CINNAMON:** SWEETENER: XYLITOL, GUM BASE, FLAVOUR, THICKENING AGENT: GUM ARABIC, HUMECTANT: GLYCERIN, EMULSIFIER: LECITHIN (SUNFLOWER), COLOURING AGENT: CALCIUM CARBONATE, COATING AGENT: CARNAUBA WAX. **INGREDIENTS FRESH FRUIT AND CRANBERRY:** SWEETENER: XYLITOL, GUM BASE, FLAVOUR, THICKENING AGENT: GUM ARABIC, HUMECTANT: GLYCERIN, ACIDITY REGULATOR: MALIC ACID, EMULSIFIER: LECITHIN (SUNFLOWER), COLOURING AGENT: CALCIUM CARBONATE, COATING AGENT: CARNAUBA WAX. **INGREDIENTS GREEN TEA:** SWEETENER: XYLITOL, GUM BASE, FLAVOUR, THICKENING AGENT: GUM ARABIC, HUMECTANT: GLYCERIN, LEAF EXTRACT (GREEN TEA), EMULSIFIER: LECITHIN (SUNFLOWER), COLOURING AGENT: CALCIUM CARBONATE, COATING AGENT: CARNAUBA WAX. **INGREDIENTS WATERMELON:** SWEETENER: XYLITOL, GUM BASE, FLAVOUR, ACIDITY REGULATOR: MALIC ACID, CITRIC ACID, COLOURING AGENT: CALCIUM CARBONATE, THICKENING AGENT: GUM ARABIC, HUMECTANT: GLYCERIN, EMULSIFIER: LECITHIN (SUNFLOWER), COATING AGENT: CARNAUBA WAX. **INGREDIENTS APPLE AND STRAWBERRY:** SWEETENER: XYLITOL, CHEWING BASE, AROMA, ACIDITY REGULATOR: MALIC ACID, THICKENING AGENT: GUM ARABIC, HUMECTANT: GLYCERINE, COLOURANT: CALCIUM CARBONATE, EMULSIFIER: LECITHIN (SUNFLOWER), COATING: CARNAUBA WAX. **NUTRITIONAL INFORMATION PEPPERMINT, GREEN TEA, CRANBERRY PER 100 G:** ENERGY: 756 KJ/ 172,8 KCAL; FAT: 0 G; OF WHICH SATURATED FATTY ACIDS 0 G; CARBOHYDRATES: 72 G; OF WHICH SUGAR: 0 G; PROTEIN: 0 G; SALT: 0 G. **NUTRITIONAL INFORMATION CINNAMON, STRAWBERRY PER 100 G:** ENERGY: 746 KJ/170,4 KCAL; FAT: 0 G; OF WHICH SATURATED FATTY ACIDS 0 G; CARBOHYDRATES: 71 G; OF WHICH SUGAR: 0 G; PROTEIN: 0 G; SALT: 0 G. **NUTRITIONAL INFORMATION FRESH FRUIT, SPEARMINT PER 100 G:** ENERGY: 766 KJ/ 175,2 KCAL; FAT: 0 G; OF WHICH SATURATED FATTY ACIDS 0 G; CARBOHYDRATES: 73 G; OF WHICH SUGAR: 0 G; PROTEIN: 0 G; SALT: 0 G. **NUTRITIONAL INFORMATION APPLE PER 100 G:** ENERGY: 735 KJ/ 168 KCAL; FAT: 0 G; OF WHICH SATURATED FATTY ACIDS 0 G; CARBOHYDRATES: 70 G; OF WHICH SUGAR: 0 G; PROTEIN: 0 G; SALT: 0 G. **NUTRITIONAL INFORMATION WATERMELON PER 100 G:** ENERGY: 744 KJ/ 177,6 KCAL; FAT: 0 G; OF WHICH SATURATED FATTY ACIDS 0 G; CARBOHYDRATES: 74 G; OF WHICH SUGAR: 0 G; PROTEIN: 0 G; SALT: 0 G. **NOTES:** CHEWING GUM WITH SWEETENER. EXCESSIVE CONSUMPTION MAY HAVE LAXATIVE EFFECTS! PLEASE PAY ATTENTION TO A BALANCED AND VARIED DIET AND A HEALTHY LIFESTYLE. RECOMMENDED DAILY ALLOWANCE: ADULTS 1-10 PIECES. NOT FOR CHILDREN UNDER THREE YEARS (RISK OF SUFFOCATION IF SWALLOWED). LIFE-THREATENING FOR PETS.

## Plaque Agent®

### Plaque disclosing liquid

- Existing plaque is revealed in blue
- Pleasant "bubble gum" flavor
- Ready-to-use, motivating, child-friendly
- Coloring can be easily removed by brushing teeth
- Application: 1 – 2 x per day 10 ml, rinse for approx. 30 sec. prior to toothbrushing
- Erythrosine-free, alcohol-free
- Incl. dosing cap

Article	Content	REF
Plaque Agent	500 ml	631 096
Plaque Agent display	5 bottles	635 176



## Funny Animals

### Hygienic toothbrush holder

- Easy snapping in place and removal of toothbrush
- Patented snap lock
- With two suction cups, attachable to any smooth surface
- Ventilation slots ensure an ideal air exchange
- Fitting for any off-the-shelf toothbrush
- For children from the age of three

Article	REF
Funny Cow	630 099
Funny Giraffe	630 220
Funny Panda	630 222
Funny Lion	630 102
Funny Elephant	630 100
Funny Cat	630 226



**Suction cups**  
attachable to any  
smooth surface

## Kid's Brush

### Children's Toothbrush

- Small head with oval bristle field
- Plane tuft field with soft rounded nylon bristles
- "Upper body" is hinged and protects the bristle field
- Air circulation by opening in the protective cap
- Brush handle also serves as practical stand
- For children from the age of four

Article	REF
Kid's Brush Duck (2)	630 046
Kid's Brush Parrot (1)	630 047
Kid's Brush Bear (4)	630 048
Kid's Brush Dog (3)	630 049
Kid's Brush Set, 4 pcs. assorted	605 820





## Mirapont®

A pale, highly precise special acrylat for stumps, hard plastic models and single teeth

- Very thin and slightly fluent material
- Both liquids (components A and B, relation 1:1) are mixed within 30 sec.
- Can be poured into silicone, alginate, reversible hydrocolloid and thermoplastic
- After 90 min. it can be sawed, milled and polished

Article	Content	REF
Mirapont 500 g	250 g liquid A, 250 g liquid B, 2 dosage bottles A and B, 200 ml Agent Plus, 50 g Silifit, 5 measuring cups, 1 shaker with pouring spout, 2 big mixing spatulas, 5 small mixing spatulas, one-way gloves	203 010
Mirapont 1,000 g	2 x 250 g liquid A, 2 x 250 g of liquid B, 2 dosage bottles A and B, 200 ml agent plus, 50 g silifit, 5 measuring cubs, 1 shaker with pouring spout, 2 big mixing spatulas, 5 small mixing spatulas, one-way gloves	203 011



## Mirapont® Agent Plus

- Isolates Mirapont against waxes
- Isolates polyether and polysulfide materials against Mirapont

Article	Content	REF
Mirapont Agent Plus	200 ml	203 016

## Mirapont® Silifit

- Special block-out material, kneadable

Article	Content	REF
Mirapont Silifit	250 g	203 015



## Mirabol®

Green flexible mixing bowls

- Easy to clean
- For alginate, plaster, etc.
- Flexible material of first-class quality
- Available in three sizes/heights

Article		ø	Height	REF
Mirabol, No. 1	large	12 cm	9 cm	304 331
Mirabol, No. 2	x-large	13 cm	11 cm	304 332
Mirabol, No. 3	jumbo	17 cm	13 cm	304 333
Plaster Spatula RS				304 314



## Flex-O-Bol

Classic, dark green alginate mixing bowl

- Easy to clean, flexible
- For alginate, plaster etc.
- Available in four sizes

Article		ø	Height	REF
Flex-O-Bol, No. 1/4	small	8 cm	5.5 cm	304 320
Flex-O-Bol, No. 1/2	medium	10.5 cm	7.5 cm	304 321
Flex-O-Bol, No. 1	large	12 cm	9 cm	304 322
Flex-O-Bol, No. 2	x-large	14 cm	11 cm	304 323

## Dipol®

### Proven wetting agent for all phosphate and plaster investment materials

- For an exact and clean pour
- Wax-degreasing, reduces the surface tension of wax
- Dipol builds a molecular bridge between water-repellent wax and
- Investment compounds which can flow bubble-free and accurately adapting to the wax. Clean, smooth surfaces
- It contains no delaying chemicals which can lead to rough surfaces
- Dipol is also suited excellently as wetting agent on impressions of silicone, polyether, etc. for a trouble-free outpouring with plaster
- Free from formaldehyde and alcohol
- Without fuel gas, pumping atomizer with micro fine spray fog

Article	Content	REF
Dipol Set with 1 l bottle + 1 pump bottle (empty)	1000 ml	605 044
Dipol pump bottle, filled	100 ml	605 043
Dipol pump bottle, empty		605 045



## Mirapor®

### Isolates plaster from plaster

- Without any film build-up, not silicon binding
- Precise, very simple separation
- Plaster parts release without aid
- No discoloration of the models
- Surfaces are sealed against dirt and water
- Plaster surfaces can be polished brilliantly with a brush or a cloth
- Without fuel gas, formaldehyde-free

Article	Content	REF
Mirapor Set with 1 l bottle + 1 pump bottle (empty)	1000 ml	605 113
Mirapor pump bottle, filled	100 ml	605 119
Mirapor pump bottle, empty		605 114



## Mirawet®

### Disinfecting mixing liquid for all kinds of pumice powder

- Keeps the polishing compound creamy all day long
- Excellent bactericidal, fungicidal and tuberculocidal effect
- Virus-deactivating, effective against HBV and HIV viruses
- Skin-protecting, pH-neutral
- Biologically degradable and free from formaldehyde

Article	Content	REF
Mirawet	5000 ml	554 105





## Alminax

### Aluminum wax

- For absolutely precise bite registration
- Stable wax sheets (3 mm thick)
- High percentage of aluminum keeps the sheets warm very well
- Extremely hard after cooling off
- Just heat up with warm water

Article	Content	REF
Alminax	250 g/ 11 Lagen	101 301



## Alminax Rite-Bite

### Preformed bite indexes from special aluminum wax

- Very stable due to a reinforcing aluminum section
- Precise bite registration without interfering with the tongue
- Warmed up quickly in 50 °C hot water, Rite-Bite is individually mouldable, cooled off extremely hard and shape-retaining
- 2.5 mm thick bite index for optimal bite registration and precise working
- Also ideal for face bow registration

Article	REF
Alminax Rite-Bite, box of 24 reinforced and 6 plain indexes	101 302



## Corund SC

### Long-lasting finishing and grinding paper

- In the grain size 80 (very coarse) – 220 (fine)
- The pointed grain is preserved for a long time
- 15 mm wide

Article	Length	Grain	REF
Corund SC No. 80	25 m	80	605 016
Corund SC No. 100	30 m	100	605 017
Corund SC No. 120	30 m	120	605 018
Corund SC No. 150	30 m	150	605 019
Corund SC No. 180	50 m	180	605 020
Corund SC No. 220	50 m	220	605 021



## Non-Stick®

### Special silicone spray

- Isolation, protection and care spray
- Essential to ensure long service life of articulators
- Condyles, balls and all movable parts are gliding very easily
- For surface isolation against plaster of model holders (norm)
- Prevents sticking of plaster on trimmers, flasks and elastic layers, etc.
- Makes devices hinges smooth-running

Article	Content	REF
Non-Stick	400 ml	554 206

## Occlu® Spray Plus

### Green occlusion spray

- To mark contact points by spraying directly onto the occlusal surfaces or inside of crowns
- Micro powder layer for highest accuracy
- Plastic nozzle for fine spray mist
- Powder layer can easily be removed with water, economic consumption

Article	Content	REF
Occlu Spray Plus	75 ml	554 205
Occlu Spray Plus	50 ml	554 211



## Vernax® S/Vernax® G

### Insulating varnishes for stumps etc.

- Silver- and golden-colored
- Even film of approx. 10 µm
- Indissoluble against isolating means and evaporation
- Heat-proof during the deep drawing and by the use of diving wax
- Quick-drying

Article	Content	REF
Vernax S (silver), bottle with brush	20 ml	605 065
Vernax G (gold), bottle with brush	20 ml	605 066



## Vernax® Thinner

- Clear liquid to thin Vernax 100, Vernax S., Vernax G as well as Vernax Antagon

Article	Content	REF
Vernax thinner, bottle with brush	20 ml	605 068

## Vernax® 100

### Insulating varnish, 100 % of fine silver for stumps etc.

- Absolutely steady film of 8 – 10 µm (1 layer)
- Can also be applied in several layers
- Indissoluble against all isolating agents and evaporation
- Heat-proof during the deep drawing and by the use of diving wax
- Quick-drying
- Can be cleanly removed with acetone
- Recommended for full ceramic inlays and crowns, etc. (e.g. Empress, Ivoclar)

Article	Content	REF
Vernax 100, bottle with brush	20 ml	605 063



## Vernax® Colloidal Graphite

### Dark graphite in liquid form

- With integrated brush easy to apply
- Solder does not flow over the graphite limitation
- No lunker building within the joint
- Makes telescope and conical crowns move smoothly
- Diluteable with water

Article	Content	REF
Vernax Colloidal Graphite, bottle with brush	20 ml	605 069



All Vernax products come with an integrated brush at the inside of the sealing cap.



Button fixation

Screw fixation

## Orbatec® Prophyl

### Prophylaxis straight hand pieces and contra-angles

- For prophyl cups and brushes with screw and button fixation
- From 0 – 5,000 rpm
- Fit any standard micro motor with plane shaft
- Autoclavable

Article	REF
Orbatec Prophyl WST PK (button fixed)	452 152
Orbatec Prophyl WST PS (screw fixed)	452 153

Prophy-Angles and Prophy-Cups see page 39.



WST

HST

## Orbatec®

### Standard hand pieces and contra-angles

- Fit any standard micro motor with plane shaft
- Autoclavable

Article	REF
Orbatec WST (30 BL) 30.000 U/min	452 150
Orbatec HST (30 A) 40.000 U/min	452 158



## Miracast

### Model former

- With vertical retention marks inside
- Inexpensive, in three sizes

Article	Size	REF
Miracast UK small	80 x 60 x 15 mm	203 066
Miracast UK medium	85 x 65 x 15 mm	203 067
Miracast OK small	75 x 60 x 15 mm	203 065
Miracast OK medium	80 x 61 x 15 mm	203 068
Miracast OK large, fits for upper and lower impressions	100 x 80 x 15 mm	203 069



## Protho Clean®

### Cleansing and high-gloss polish of restorations

- Esthetically upgrades the presentation of your prosthetic works
- Removes polishing agent and monomer residues from prosthetic work
- Spray on and leave for a short while before wiping off with a soft cloth
- Pleasant mint flavor

Article	Content	REF
Protho Clean	75 ml	554 220



## Dentemp® Crown & Caps\*

### Repair kit for loose crowns and lost fillings

- Temporary repair of crowns and fillings
- Fast pain relief
- For home use and ideal when traveling
- For 12 applications

Article	Content	REF
Dentemp Crown & Caps	1 jar with 2.2 g ready-to-use paste, 1 x applicator	MARADOC01

\*This product should not be used when throbbing pain or swelling is experienced.



## Dentemp® Repair it\*

### Repair kit for dentures

- For denture fractures and loose denture teeth
- Reduces pain and pressure points
- For home use and ideal when traveling
- For 3 applications

Article	Content	REF
Dentemp Repair it	3 x 1 g powder, 3 x 1 g liquid, 3 x mixing bowls, 2 x abrasive paper, 1 x spatula	MARADOC02

\* Avoid skin contact with the product!



## Dentemp® Reline it\*

### Relining material for dentures

- Precise and secure fit of your denture
- Zinc-free material
- For home use
- For 2 adjustments

Article	Content	REF
Dentemp Reline it	2 x 3.1 g powder, 2 x 3.3 g liquid, 2 x mixing bowls, 1 x spatula	MARADOC03

\* Do not apply to an existing reline. Always remove the old relining first!



## XyliPOP® (see page 85)

**INGREDIENTS XYLIPOP STRAWBERRY:** SWEETENER: XYLITOL; STABILISER: ISOMALT; THICKENING AGENT: GUM ARABIC; FLAVOR; STRAWBERRY EXTRACT; ACIDITY REGULATOR: CALCIUM LACTATE; ACIDIFYING AGENT: CITRIC ACID; SEPARATING AGENT: MAGNESIUM STEARATE; COLOURING AGENT: BEETROOT RED.

**INGREDIENTS XYLIPOP BLUEBERRY:** SWEETENER: XYLITOL; STABILISER: ISOMALT; THICKENING AGENT: GUM ARABIC; FLAVOR; ACIDITY REGULATOR: CALCIUM LACTATE; BLUEBERRY POWDER; ACIDIFYING AGENT: CITRIC ACID, MALIC ACID; SEPARATING AGENT: MAGNESIUM STEARATE.

**INGREDIENTS XYLIPOP BANANA:** SWEETENER: XYLITOL, ISOMALT, GUM ARABIC, FLAVORS, CALCIUM LACTATE, BANANA POWDER, DL-MALIC ACID, MAGNESIUM STEARATE, BETA-CAROTENE.

**NUTRITIONAL INFORMATION PER 100 G STRAWBERRY:** ENERGY: 815 KJ/195 KCAL, FAT 0 G, OF WHICH SATURATED FATTY ACIDS 0 G, CARBOHYDRATES 87 G, OF WHICH SUGAR 0 G, PROTEIN 0 G, SALT 0 G.

**NUTRITIONAL INFORMATION PER 100 G BLUEBERRY:** ENERGY: 900KJ/216 KCAL, FAT 0 G, OF WHICH SATURATED FATTY ACIDS 0 G, CARBOHYDRATES 90 G, OF WHICH SUGAR 0 G, PROTEIN 0 G, SALT 0 G

**NUTRITIONAL INFORMATION PER 100 G BANANA:** ENERGY: 890KJ/213,6 KCAL, FAT 0 G, OF WHICH SATURATED FATTY ACIDS 0 G, CARBOHYDRATES 89 G, OF WHICH SUGAR 0 G, PROTEIN 0 G, SALT 0 G

## AQUAMED® Chewing Gum (see page 86)

**INGREDIENTS AQUAMED CHEWING GUM:** SWEETENER: XYLITOL, GUM BASE, FLAVOUR, ACIDITY REGULATOR: MALIC ACID, COLOURING AGENT: CALCIUM CARBONATE, THICKENING AGENT: GUM ARABIC, HUMECTANT: GLYCERIN, EMULSIFIER: LECITHIN (SUNFLOWER), COATING AGENT: CARNAUBA WAX

**NUTRITIONAL INFORMATION PER 100 G:** ENERGY 744 KJ/177,6 KCAL, FAT 0 G, OF WHICH SATURATED FATTY ACIDS 0 G, CARBOHYDRATES 74 G, OF WHICH SUGAR 0 G, PROTEIN 0 G, SALT 0 G.



## Mara® Expert Floss sticks

- Dental floss sticks with special coating: fluoride, xylitol, CHX and mint
- Extra strong, tear-resistant dental floss
- With toothpick function
- Ideal for on the go (in a zip bag)

Article	Content	REF
Mara Expert Floss sticks	48 pcs.	MARAZS01



## Mara® Expert Interdental brushes „basic“

- Soft premium bristles with mint flavor
- Soft grip for secure hold
- Ideal for on the go (in a zip pouch)
- Without protective cap

Article	ISO	Ø Wire	Passage Hole Diameter	Content	REF
Mara Expert „basic“, pink	ISO 0 (extra fine)	0.4 mm	< 0.6 mm	24 pcs.	MARAIDS00
Mara Expert „basic“, red	ISO 2 (medium fine)	0.5 mm	0.9 – 1.0 mm	24 pcs.	MARAIDS02
Mara Expert „basic“, blue	ISO 3	0.6 mm	1.1 – 1.2 mm	24 pcs.	MARAIDS03
Mara Expert „basic“, yellow	ISO 4	0.7 mm	1.3 – 1.5 mm	24 pcs.	MARAIDS04



100 pcs.

12 pcs.

**Each brush with protective cap!**

## Mara® Expert Interdental Brushes „Premium Line“

- Soft premium bristles coated with fluoride, CHX and mint flavour
- Plastic-coated, medical stainless steel wire
- Hygienic protective cap, also serves as handle extension
- Soft handle for a secure hold, colour-coded in accordance with ISO norm

Article	ISO	Ø Wire	Passage Hole Diameter	Content	REF
Mara Expert „Premium Line“ pink	ISO 0 (extra fein)	0.4 mm	< 0.6 mm	12 pcs.	MARAID00
Mara Expert „Premium Line“, orange	ISO 1 (fine)	0.45 mm	0.7 – 0.8 mm	12 pcs.	MARAID01
Mara Expert „Premium Line“, red	ISO 2 (medium fine)	0.5 mm	0.9 – 1.0 mm	12 pcs.	MARAID02
Mara Expert „Premium Line“, blue	ISO 3	0.6 mm	1.1 – 1.2 mm	12 pcs.	MARAID03
Mara Expert „Premium Line“, yellow	ISO 4 (medium wide)	0.7 mm	1.3 – 1.5 mm	12 pcs.	MARAID04
Mara Expert „Premium Line“, green	ISO 5 (wide)	0.8 mm	1.6 – 1.8 mm	12 pcs.	MARAID05

Article	ISO	Ø Wire	Passage Hole Diameter	Content	REF
Mara Expert „Premium Line“, pink	ISO 0 (extra fine)	0.4 mm	< 0.6 mm	100 pcs.	MARAIDZ0
Mara Expert „Premium Line“, orange	ISO 1 (fine)	0.45 mm	0.7 – 0.8 mm	100 pcs.	MARAIDZ1
Mara Expert „Premium Line“, red	ISO 2 (medium fine)	0.5 mm	0.9 – 1.0 mm	100 pcs.	MARAIDZ2
Mara Expert „Premium Line“, blue	ISO 3	0.6 mm	1.1 – 1.2 mm	100 pcs.	MARAIDZ3
Mara Expert „Premium Line“, yellow	ISO 4	0.7 mm	1.3 – 1.5 mm	100 pcs.	MARAIDZ4
Mara Expert „Premium Line“, green	ISO 5	0.8 mm	1.6 – 1.8 mm	100 pcs.	MARAIDZ5

## Mara® Expert Charcoal Intensive

Dental care jelly for pearly-white teeth

- Charcoal cleans thoroughly
- Aloe vera soothes and cares for the gums
- Himalayan mint provides fresh breath
- Sodium fluoride (1,450 ppm) protects against tooth decay

Article	Content	REF
Mara expert Charcoal Intensive, jelly	50 ml	MARAAK03



## Mara® Expert Charcoal Plus Sensitive

Special toothpaste: natural whiteness and protection for sensitive teeth

- Trendy product with charcoal plus formula
- With double-acting formula: black stripe – charcoal formula for naturally white teeth, white stripe – protection against pain sensitivity
- Calming of the tooth nerve with potassium ions
- Fresh and mild mint aroma for fresh breath
- Sodium fluoride 1.450 ppm

Article	Content	REF
Mara Expert Charcoal Plus Sensitive	75 ml	MARAAK02



## Mara® Expert ecosmile

Interdental brushes

- Environmentally friendly, vegan alternative for your daily dental care
- Bristles made of organic plastic
- Ergonomic handle made of 100 % birch wood
- Suitable for bridges, brackets and implants
- With protective cap made of bio-based plastic
- Ecological packaging with 8 pieces



Article	ISO	Ø Wire	Passage Hole Diameter	Content	REF
Mara Expert Ecosmile, pink	ISO 0 (extra fine)	0.4 mm	<0.6 mm	8 pcs.	MARAES00
Mara Expert Ecosmile, orange	ISO 1 (fine)	0.45 mm	0.7 – 0.8 mm	8 pcs.	MARAES01
Mara Expert Ecosmile, red	ISO 2 (medium fine)	0.5 mm	0.9 – 1.0 mm	8 pcs.	MARAES02
Mara Expert Ecosmile, blue	ISO 3 (medium)	0.6 mm	1.1 – 1.2 mm	8 pcs.	MARAES03
Mara Expert Ecosmile, yellow	ISO 4 (medium wide)	0.7 mm	1.3 – 1.5 mm	8 pcs.	MARAES04



facebook



Instagram Nametag – scan directly in the app



YouTube



More special offers

Subscribe to newsletter now



Hager & Werken GmbH & Co. KG  
 Ackerstraße 1, 47269 Duisburg, Germany  
 Tel. +49 (203) 99269-0  
 Fax +49 (203) 299283  
 E-Mail info@hagerwerken.de  
 Website www.hagerwerken.de

Please see our general terms and conditions at [www.hagerwerken.de](http://www.hagerwerken.de).  
 ©2023 by Hager & Werken. Mistakes and printing errors are non-binding.