

**Hammacher**  
Instrumente



# DENTAL

98

CATALOGUE

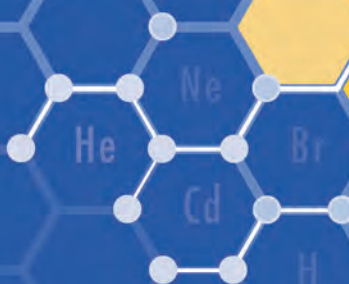

Mg

Pb



**Solingen**



# Hammacher Instrumente

1922 gegründet verfügt die Karl Hammacher GmbH über fast 100 Jahre Erfahrung und Tradition

Founded in 1922 Karl Hammacher GmbH disposes of nearly 100 years of experience and tradition

Wir über uns

About us



Internet: [www.hammacher.de](http://www.hammacher.de)  
em@il: [post@hammacher.de](mailto:post@hammacher.de)

Solingen

# Instrumentenpflege

Für die Herstellung unserer Instrumente verwenden unsere qualifizierten Chirurgiemechaniker hochwertige Edelstähle, die sorgfältig be- und verarbeitet werden. Dennoch ist eine sorgfältige Pflege der Instrumente überaus wichtig.

## Pflegetipps

- Vor dem ersten Gebrauch müssen die Instrumente gereinigt, getrocknet und sterilisiert werden.
- Das Instrumentarium sollte auf schonende Weise gehandhabt werden.
- Die Instrumente sollten nach Gebrauch gereinigt werden.
- Es ist auf die richtige Eignung und Dosierung der Reinigungs- bzw. Desinfektionsmittel zu achten.
- Instrumente mit Gelenken sollten in geöffnetem Zustand gereinigt bzw. desinfiziert werden.
- Die schonendste Behandlung ist die Reinigung per Hand – dabei sollten weder Metallbürsten noch Scheuermittel verwendet werden.
- Feine und empfindliche Instrumente – auch Mundspiegel – sollten nur von Hand gereinigt werden.
- Bei einer maschinellen Reinigung muss unbedingt auf eine sichere Verankerung der Instrumente und die Einhaltung der Gebrauchsanweisung der Gerätehersteller geachtet werden.
- Rostfreie Instrumente sind unbedingt getrennt von nicht rostfreien, alten, beschädigten, vernickelten und verchromten Instrumenten zu reinigen, da sonst die Gefahr von Flugrost besteht.
- Bei scharfen Reinigungsmitteln (z.B. Zemententferner) muss auf die genaue Dosierung und Einwirkzeit geachtet werden, da sonst – insbesondere bei der Ultraschallreinigung – die Instrumente sehr stark angeheizt werden.
- Nach jedem Reinigungsvorgang müssen die Instrumente mehrmals gründlich mit destilliertem oder vollentsalztem Wasser abgespült, danach getrocknet sowie auf Sauberkeit und Funktion geprüft werden.
- Nasse Instrumente dürfen nicht in den Autoklaven oder den Heißluftsterilisator gegeben werden.
- Bei chemischen Produkten und Geräten ist genau auf die Herstellerhinweise zu achten.

**Diese Tipps werden Ihr hochwertiges Instrumentarium lange Zeit erhalten !!**

# Maintenance of instruments

For the manufacturing of our instruments our high qualified surgical mechanics use high quality stainless steels which will be carefully worked at. Nevertheless a conscientious maintenance of the instruments is particularly important.

## Maintenance tips

- Prior to the first use the instruments should be cleaned, dried and sterilized.
- The instruments should be handled with care.
- After use the instruments should be cleaned.
- The correct suitability and dosage of the detergent or disinfectant solutions must be considered.
- Instruments with joints have to be opened before cleaning and disinfection.
- The most careful treatment is the manual cleaning – do not use wire brushes or abrasive cleaners.
- Delicate instruments – also mouth mirrors – should be cleaned by hand
- When using ultrasonic machines or thermodisinfector it is imperative to ensure a secure anchoring of the instruments and compliance with the instructions for use of the equipment manufacturers.
- Do not mix up stainless, carbon steel, old, damaged, nickel or chrome plated instruments for cleaning as this may cause corrosion.
- In the case of strong cleaning agents (f. e. cement remover) the exact dosage and exposure time must be taken into consideration, as otherwise the instruments are heated very strongly – especially during ultrasonic cleaning.
- After each cleaning process the instruments have to be rinsed thoroughly with distilled or deionized water, then dried and checked for cleanliness and function.
- Wet instruments must not be placed in the autoclave or hot-air sterilizer.
- For chemical products and devices the manufacturer's instructions have to be observed.

**These tips will help you to keep your high quality instrument for a long time !!**

# SERVICE

wird bei uns groß geschrieben!

We consider SERVICE one of the main aspects of our philosophy!

Zu unseren Leistungen gehört selbstverständlich auch ein Reparaturservice,  
der unter anderem folgende Arbeiten umfaßt:

As part of our service, we offer our customers a repair service,  
including the following work processes:



1  
Diamantierung und Nachdiamantierung von  
Zahnzangen, Pinzetten, Teleskopzangen, etc., ...  
Diamond coating and re-coating of  
extracting forceps, telescope crown pliers, etc.,...

**Diamantierung**  
**Diamond coating**

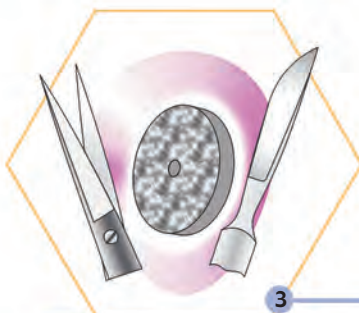

3  
Schärfen und Nachschleifen von Scheren, Skalpell  
und sonstigen schneidenden Instrumenten  
Sharpening and regrinding of scissors, scalpels  
and other cutting instruments

**Schärfen**  
**Tool sharpening**



5  
Oberflächenbearbeitung der Instrumente, wie:  
Mattieren, Polieren, Verchromen und Vergolden  
Surface finishing of instruments, such as  
matt finishing, polishing, chrome and gold plating

**Oberflächenbearbeitung**  
**Surface finishing**



7  
Wir produzieren für Sie in Sonderanfertigung Instrumente  
nach Muster, Skizze oder ähnlichem  
For our customers, we manufacture custom-made instruments  
to specification from your samples, drawings etc.

**Sonderanfertigung**  
**Customised Instruments**



2  
Erneuerung von Hartmetall-Einlagen für  
Nadelhalter und technische Zangen  
Replacement of tungsten carbide inserts for  
needle holders and technical pliers

**TC-Einsätze**  
**TC-inserts**



4  
Komplettes Nacharbeiten älterer Instrumente, wie:  
Nachpolieren, Richten, gängig machen und Entrosten  
Complete refinishing of old instruments, such as  
surface redressing, alignment, rust removal and making instruments patent

**Nacharbeit**  
**Refinishing**

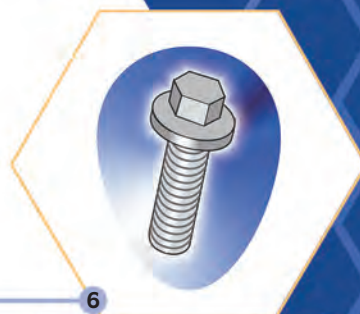

6  
Ersatz von Schrauben, Stiften oder Nieten  
Replacement of screws, pins and rivets

**Ersatz**  
**Replacement of parts**



## Zertifikat

### Die Zertifizierungsstelle

**MEDCERT Zertifizierungs- und Prüfungsgesellschaft für die Medizin GmbH  
Pilatuspool 2 – 20355 Hamburg – Deutschland**

bescheinigt hiermit, dass das Unternehmen

**Karl Hammacher GmbH  
Steinendorfer Straße 27  
42699 Solingen  
Deutschland**

in den folgenden Bereichen ein Qualitätssicherungssystem eingeführt hat, anwendet und aufrechterhält:

**Herstellung, Reparatur, Endprüfung und Vertrieb von  
wiederverwendbaren zahnärztlichen und chirurgischen Instrumenten**

**Handel mit Instrumenten und Verbrauchsmaterialien**

Durch ein Audit wurde der Nachweis erbracht, dass das Qualitätsmanagementsystem die Forderungen der unten genannten Norm erfüllt:

### **EN ISO 13485:2016**

Dies wird von MEDCERT überwacht.

**Gültig ab: 2021-02-08**  
**Gültig bis: 2024-02-07**

Berichts-Nr.: 3141FS17F  
Verfahrens-Nr.: QS – 3141  
Zertifikats-Nr.: 3141DE445210208A

Hamburg, 2021-02-08

  
\_\_\_\_\_  
MEDCERT Zertifizierungsstelle  
(Lorenz Runge)

Das Zertifikat ist nur gültig, wenn es mit allen Seiten vollständig vorliegt. Bitte wenden Sie sich an [info@medcert.de](mailto:info@medcert.de), um die Gültigkeit des Zertifikats zu überprüfen.

MEDCERT ist eine von der DAkkS akkreditierte  
Zertifizierungsstelle für Managementsysteme.

Form F10010017 DE / Rev. 9 / 2019.11.14

## Certificate

### The certification body

**MEDCERT Zertifizierungs- und Prüfungsgesellschaft für die Medizin GmbH  
Pilatuspool 2 – 20355 Hamburg – Germany**

herewith certifies that the company

**Karl Hammacher GmbH  
Steinendorfer Straße 27  
42699 Solingen  
Germany**

has introduced, applies and maintains a quality management system in the area of:

**Purchase, manufacture, final inspection, storage and  
distribution of reusable dental and surgical instruments**

**Distribution of instruments and disposables**

The conformity of this quality management system to the requirements of the below mentioned standard was verified by an audit:

### **EN ISO 13485:2016**

This certification is subject to surveillance by MEDCERT.

**Effective date: 2021-02-08**

**Expiry date: 2024-02-07**

Report No.: 3141FS17F

Procedure No.: QS – 3141

Certificate No.: 3141GB445210208A

Hamburg, 2021-02-08

  
\_\_\_\_\_  
MEDCERT Certification Body  
(Lorenz Runge)

The certificate is only valid when provided entirely with all of its pages.  
To verify the validity of this certificate, contact [info@medcert.de](mailto:info@medcert.de).

MEDCERT is a DAkkS accredited management systems  
certification body

Form F10010017e EN / Rev. 9 / 2019.11.14



## STAINLESS STEEL

**Instrumente aus rostfreiem Stahl** sind rost sicher jedoch nicht rostfrei wie die Wironit Instrumente.

**Instruments made of stainless steel** are rust proof but not rust-free like the Wironit instruments.

---



## TITANIUM

**Titan Instrumente** sind 40 % leichter als Instrumente aus rostfreiem Stahl – sie sind absolut rost sicher und geeignet für alle gängigen Reinigungs- und Sterilisationsarten.

**Titanium instruments** are 40% lighter than instruments made of stainless steel - they are absolutely rust-proof and suitable for all common types of cleaning and sterilization.

---



## WIRONIT

*Wironit*

**Wironit Instrumente** sind aus einer Speziallegierung gefertigt und weisen folgende Vorteile auf:

- ✓ nichtrostend
- ✓ antimagnetisch
- ✓ säurebeständig

Sie sind formschön, liegen leicht in der Hand und sind von langer Lebensdauer.

**Wironit instruments** are made of a special alloy and show the following advantages:

- ✓ rust resistant
- ✓ anti-magnetic
- ✓ acid resistant

They are beautifully designed and of unlimited durability.

---

Alle mit CE gekennzeichneten Produkten sind Medizinprodukte  
Alle nicht mit CE gekennzeichneten Produkten sind keine Medizinprodukte

All products marked with CE are medical devices  
All products not marked with CE are no medical devices



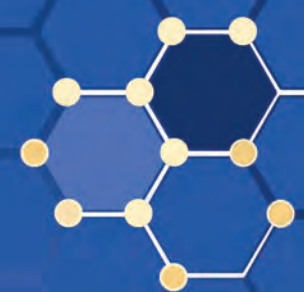

Seiten / Pages

Kapitel / Chapter

<b>Diagnostik</b> Diagnostics	1	1
<b>Extraktion</b> Extraction	15	2
<b>Chirurgie</b> Surgery	45	3
<b>Parodontologie</b> Periodontology	104	4
<b>Endodontie</b> Endodontics	121	5
<b>Implantologie</b> Implantology	131	6
<b>Konservierende Behandlung</b> Conservative treatment	157	7
<b>Prothetik</b> Prosthetics	195	8
<b>Dental Labor</b> Dental laboratory	215	9
<b>Reinigung &amp; Pflege</b> Cleaning & care	226	10
<b>Instrumentensätze</b> Instruments sets	230	11
<b>Solingen Classics</b>	247	12



Solingen



**Das Hammacher Bestell-Nummern-System**  
**The Hammacher order-number-system**

Bestellbeispiel  
 Ordering example

## HSJ 001-06

H	S	J	001	06
Hammacher	<b>STAINLESS</b>	Gruppe section	laufende Nummer current number	Figur oder Länge shape or size
		Sonden Probes	Zahnsonden, einendig mit Rundgriff Probes and explorers, single ended with round handle	fig. 6 fig. 6

## HTC 090-11

H	T	C	090	11
Hammacher	<b>TITAN</b>	Gruppe section	laufende Nummer current number	Figur oder Länge shape or size
		Pinzetten Forceps	Titan-Präparierpinzette, einfache Ausführung Titanium dissecting forceps, simple type	110 mm 110 mm

## HWC 110-10

H	W	C	110	10
Hammacher	<i>Wironit</i>	Gruppe section	laufende Nummer current number	Figur oder Länge shape or size
		Pinzetten Forceps	Mikro-Pinzetten, sehr fein, gerade Micro-forceps, very delicates, straight	105 mm 105 mm



**Solingen**



**HSJ 001-06**  
*fig. 6*

CE



**HSJ 002-17**  
*fig. 17*

CE



**HSJ 003-23**  
*fig. 23*

CE



**HSJ 004-42**  
*fig. 42*

CE



**HSJ 005-43**  
*fig. 43*

CE



**HSJ 006-44**  
*fig. 44*

CE

**Zahnsonden, einendig, mit Rundgriff**  
**Probes and explorers, single ended, with round handle**



Solingen



**HSJ 030-09**

*fig. 9*

**Ash**

**CE**

**Zahnsonden, einendig,  
mit Achteckgriff  
Probes and explorers, single  
ended, with octagonal handle**



**HSJ 053-05**

*fig. 5*

**White**

**CE**

**Zahnsonden, doppelendig, mit Achteckgriff  
Probes and explorers, double ended, with octagonal handle**



**HSJ 058-01**

*fig. 1*

**Lange**

Cavitherber / Cavit lifter

**CE**

*wironit*

- |                          |                        |
|--------------------------|------------------------|
| ✓ nichtrostend           | ✓ rust resistant       |
| ✓ antimagnetisch         | ✓ anti-magnetic        |
| ✓ säurebeständig         | ✓ acid resistant       |
| ✓ formschön              | ✓ beautifully designed |
| ✓ leicht in der Hand     | ✓ light in the hand    |
| ✓ von langer Lebensdauer | ✓ unlimited durability |

Griffstärke: Ø 4,5 mm  
Handle thickness: Ø 4,5 mm

Griffstärke: Ø 5,5 mm  
Handle thickness: Ø 5,5 mm

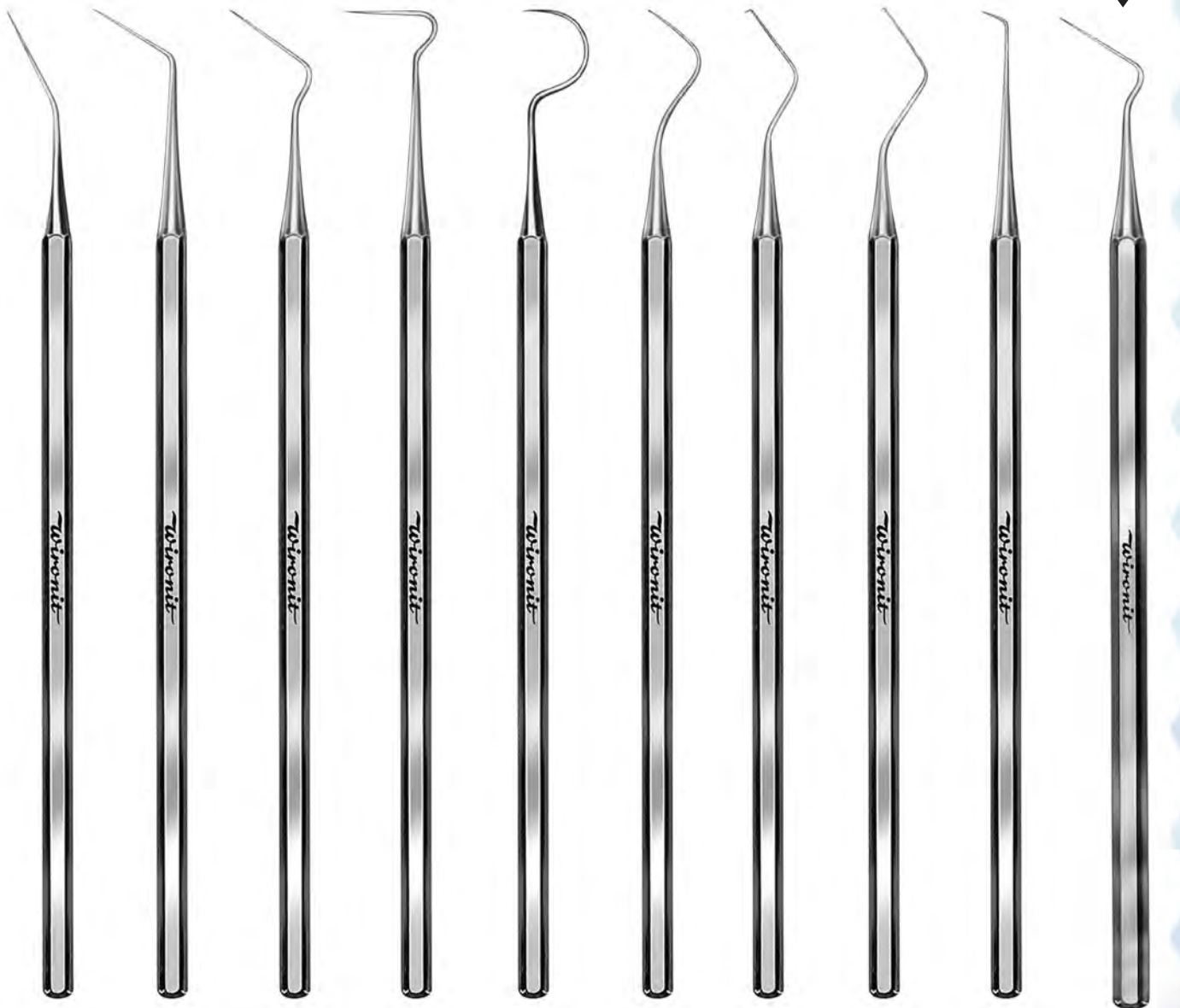

HWJ 001-05 CE    HWJ 002-06 CE    HWJ 003-09 CE    HWJ 004-08 CE    HWJ 006-23 CE    HWJ 007-43 CE    HWJ 008-17 CE    HWJ 009-18 CE    HWJ 011-16 CE    HWJ 012-09 CE

Zahnsonden, einendig, mit Achtkantgriff, aus WIRONIT  
Probes and explorers, single ended, with octagonal handle, from WIRONIT

Alle mit CE gekennzeichneten Produkte sind Medizinprodukte. | All products marked with CE are medical devices.

*wironit*

- |                          |                        |
|--------------------------|------------------------|
| ✓ nichtrostend           | ✓ rust resistant       |
| ✓ antimagnetisch         | ✓ anti-magnetic        |
| ✓ säurebeständig         | ✓ acid resistant       |
| ✓ formschön              | ✓ beautifully designed |
| ✓ leicht in der Hand     | ✓ light in the hand    |
| ✓ von langer Lebensdauer | ✓ unlimited durability |

**HWJ 015-09**  
**CE**
**HWJ 020-05**  
**CE**
**HWJ 024-00**  
 Doppelendig, mit Achtkantgriffen  
 Double-ended, with octagonal handles  
**CE**
**HWJ 030-00**  
**CE**
**HWJ 031-00**  
**CE**
**Endodontie-Sonde**  
**aus WIRONIT**  
**Endodontic explorer**  
**from WIRONIT**
**HSR 002-06**  
**CE**
**HSR 006-23**  
**CE**
**Zahnsonden aus WIRONIT**  
**Probes and explorers from WIRONIT**
**Zahnsonden mit PPSU-Griff,**  
**sterilisierbar**  
**Probes and explorers with PPSU**  
**handle, sterilizable**



**HSJ 064-42**  
*fig. 5*  
Auswechselbarer Sondeneinsatz  
für Mundspiegelgriffe  
Interchangeable probe insert  
for mouth mirror handles  
CE



**HSJ 069-09**  
*fig. 9*  
Sondenspitze mit Gewinde, passend für alle  
gängigen Griffe mit metrischem Gewinde  
Probe tips with thread, suitable for all  
standard handles with metric thread  
CE



**HWJ 090-00**  
massiv  
solid  
CE



**HWJ 091-00**  
hohl  
hollow  
CE



**HWJ 093-00**  
doppelendig  
double ended  
CE

Mundspiegelgriffe aus WIRONIT  
Mouth mirror handles from WIRONIT



**HSR 550-00**  
CE  
Mundspiegelgriff mit  
PPSU-Griff, sterilisierbar  
Mouth mirror handle with  
PPSU handle, sterilizable



**HSJ 160-00**  
Serviettenhalter – Länge verstellbar  
Napkin holder – length adjustable

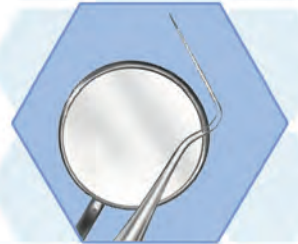

Solingen



**HSJ 102-00**  
massiv  
solid  
CE

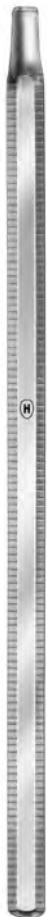

**HSJ 103-00**  
massiv  
solid  
CE



**HSJ 104-00**  
massiv  
solid  
CE



**HSJ 106-00**  
hohl  
hollow  
CE



**HSJ 108-00**  
hohl, matt  
hollow, satin-finished  
CE



**HSJ 109-01**  
hohl, matt  
hollow, satin-finished  
CE



**HSJ 116-00**  
130 mm

Griff für Spiegel und Sondeneinsätze  
für Studenten mit der Möglichkeit zur  
Aufbewahrung von Bohrern, Feilen  
usw. im Ende des Griffes  
Handle for mirrors and probe inserts  
for students with the possibility of  
storing drills, files etc. in the end of  
the handle

**Mundspiegelgriffe aus rostfreiem Stahl**  
**Mouth mirror handles from stainless steel**



**ERGO**  
*line*



**HSJ 090-01**  
graublau  
grey blue  
CE



**HSJ 091-02**  
weiss  
white  
CE



**HSJ 092-03**  
türkisgrün  
green turquoise  
CE



**HSJ 093-04**  
pastellblau  
pastel blue  
CE



**HSJ 094-05**  
rosa  
pink  
CE

**ERGO**  
*line*

#### Mundspiegelgriffe

- ✓ ergonomische Griffe mit größerem Durchmesser, Griffmulden und schlankem Griffende für ein entspanntes Zugreifen und Arbeiten
- ✓ seidenmattierte Oberfläche und abgerundete Kanten für eine angenehme Haptik sowie zur Vermeidung von Lichtreflexionen
- ✓ form- und farbbeständig sowie sterilisierbar bis 210°C

#### Mouth mirror handles

- ✓ ergonomic handles with larger diameter and slim grip end for a relaxed accessing and working
- ✓ satin mat surface and rounded edges for a comfortable haptic as well as to avoid light reflection
- ✓ form and color stable as well as sterilisable up to 210°C



### HSJ 131-04

fig. 4  
22 mm

CE

### HSJ 132-05

fig. 5  
24 mm  
hohl, vergrößernd  
magnifying

CE

### HSJ 140-04

fig. 4  
22 mm

CE

### HSJ 141-05

fig. 5  
24 mm

CE

### HSJ 142-06

fig. 6  
26 mm

plan  
plane

CE

### „HAMSO“-Mundspiegel

- ✓ (1 Verpackungseinheit = 12 Stück)
- ✓ absolut rostsicher, geeignet für alle Reinigungs- und Sterilisationsarten

### „HAMSO“ mouth mirrors

- ✓ (1 package = 12 pcs.)
- ✓ absolutely non-rusting, suitable for all kinds of cleaning and sterilization

### HSJ 150-04

fig. 4  
22 mm

CE

### HSJ 151-05

fig. 5  
24 mm  
Rhodium Front, plan, nicht  
vergrößernd  
Front surface, plane, not  
magnifying

CE



### HSJ 135-04

fig. 4  
22 mm

CE

### HSJ 136-05

fig. 5  
24 mm

CE

### „HAMSO“ Front-Mundspiegel frontverspiegelt, plan

- ✓ (1 VE = 12 Stück)
- ✓ Sehr helles, klares Bild – lichtstark
- ✓ Reflexion über 90 %
- ✓ Farbtreu
- ✓ Hohe Kratzfestigkeit
- ✓ Für alle gängigen Desinfektionen und Sterilisationsarten geeignet
- ✓ Temperaturbeständig bis 200°C / 390°F

### „HAMSO“ Front Mouth Mirrors Front surface, plane

- ✓ (1 package = 12 pieces)
- ✓ Very bright and clear picture
- ✓ Reflection over 90 %
- ✓ Colour fidelity
- ✓ Highly scratch-resistant
- ✓ Suitable for all usual kinds of disinfection and sterilisation
- ✓ Temperature-resistant up to 200°C/390°F

### Kombinierter Mundspiegel und Wangenabhalter Combined mouth mirror and cheek retractor

#### ULTRAretract FS

ULTRA FS – weltweit der hellste und schärfste Spiegel – der neue einzigartige Aufbau der reflektierenden Schichten bietet ein unübertroffen helles Spiegelbild

ULTRA FS – the brightest and sharpest mirror in the world – the new unique design of the reflective layers offers an unsurpassed bright reflection



### HSJ 125-04

Fig. 4  
plan / plane

(1 VE = 6 Stück)

(1 package = 6 pieces)

CE



### HSJ 126-05

Fig. 5  
plan / plane

(1 VE = 6 Stück)

(1 package = 6 pieces)

CE

#### Die ULTRA FS Qualitätsmerkmale sind:

- ✓ Höchste Reflexion für brillante Helligkeit
- ✓ Überlegene Farbgenauigkeit, ohne jegliche Farbverfälschung
- ✓ Exakt scharfes Spiegelbild
- ✓ Kratzfest
- ✓ Optimierte Abhalten der Wange

#### The ULTRA FS quality features are:

- ✓ Highest reflection for a brilliant brightness
- ✓ Superior colour accuracy without any colour distortion
- ✓ Exactly sharp mirror image
- ✓ Scratch-resistant
- ✓ Optimized holding of the cheek

**Spiegel aus Glas mit Rhodium verspiegelt**

- ✓ PP-Kunststoff Griff, mit Glasfaser verstärkt

**Mirrors from glass rhodium coated**

- ✓ PP plastic handle reinforced with glass fiber

134°C

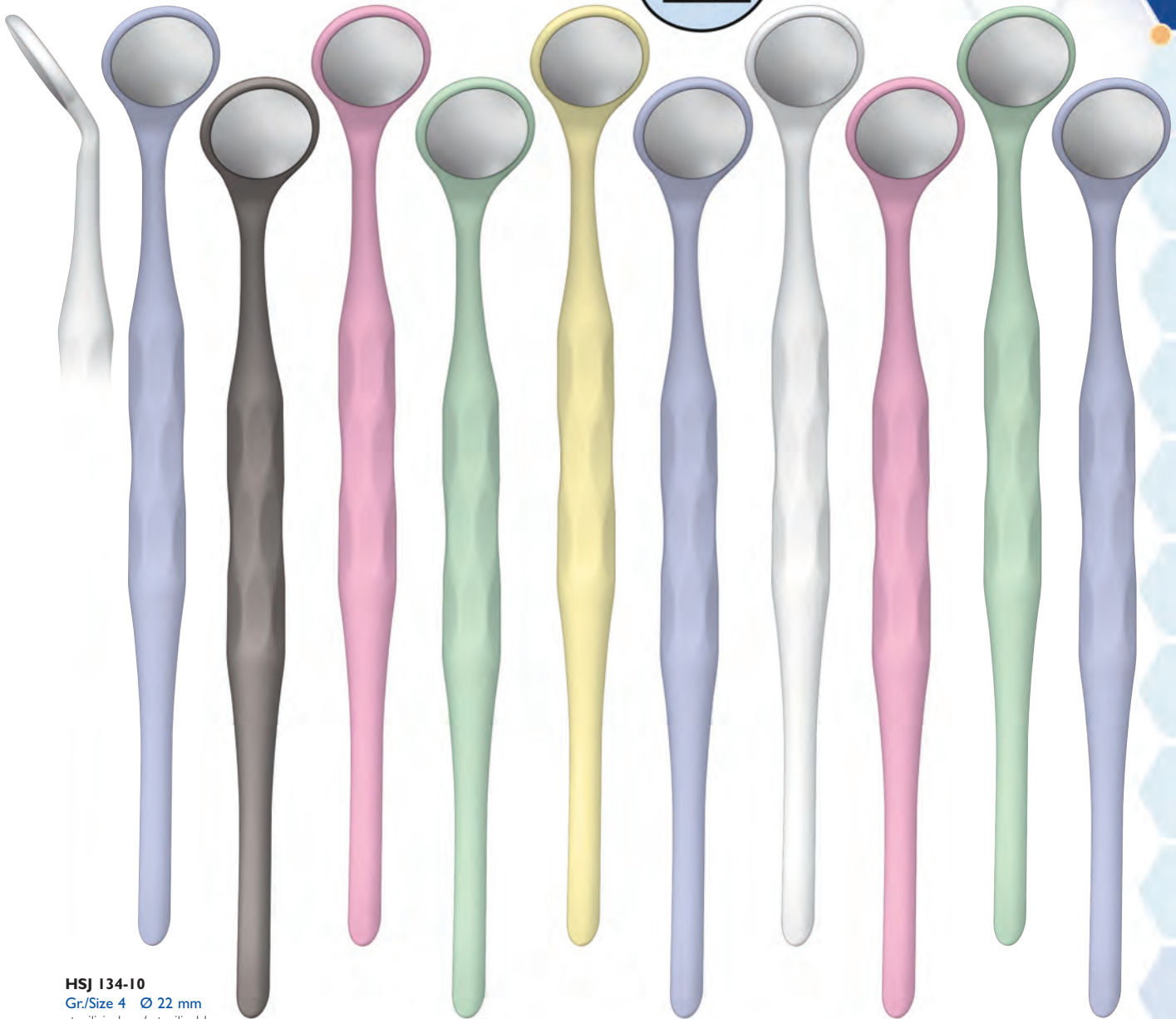

**HSJ 134-10**

Gr./Size 4 Ø 22 mm

sterilisierbar / sterilizable

RELAX | Mundspiegel | 1 VE = 10 Stück | verschiedene Farben (willkürlich)

RELAX | Mouth Mirrors | 1 pack = 10 pcs. | different colors (arbitrarily) CE

**RELAX | Mundspiegel**

Die Vorteile eines Front Surface Spiegels in Kombination mit der »lite« Konstruktion des Glasfibers, bieten Ihnen und Ihrem Patienten höchsten Komfort bei der Behandlung. Das Instrument ist autoklavierbar, säurebeständig und für den Thermodesinfektor geeignet.

- ✓ **Angenehm leicht** - für ein entspanntes Arbeiten
- ✓ **Optimiertes Halten** - durch den breit geformten Griff mit Mulden
- ✓ **Qualitätsbeständig**, farbstabil, säurefest und resistent gegenüber Plaque-Indikatoren
- ✓ **Patientenfreundlich** - durch die gerundeten Formen
- ✓ **Hygienisch** - durch den planen Übergang von Spiegel zur Fassung
- ✓ **Seidenmatte**, reflexionsfreie Oberfläche

**RELAX | Mouth Mirrors**

The benefits of a front surface mirror in combination with the "lite" construction of the fibre optic provide you and your patient with the highest level of comfort during the treatment. The instrument is autoclavable, acid-resistant and suitable for the thermal disinfectant.

- ✓ **Pleasantly light** - for a relaxed work
- ✓ **Optimized holding** - thanks to the wide handle with hollows
- ✓ **Quality resistant**, colour stable, acid resistant and resistant to plaque indicators
- ✓ **Patient friendly** - thanks to the rounded shapes
- ✓ **Hygienic** - thanks to the smooth transition from mirror to frame
- ✓ **silk mat**, non-reflecting surface

## Fotospiegel aus Metall

### Photo mirrors from metal

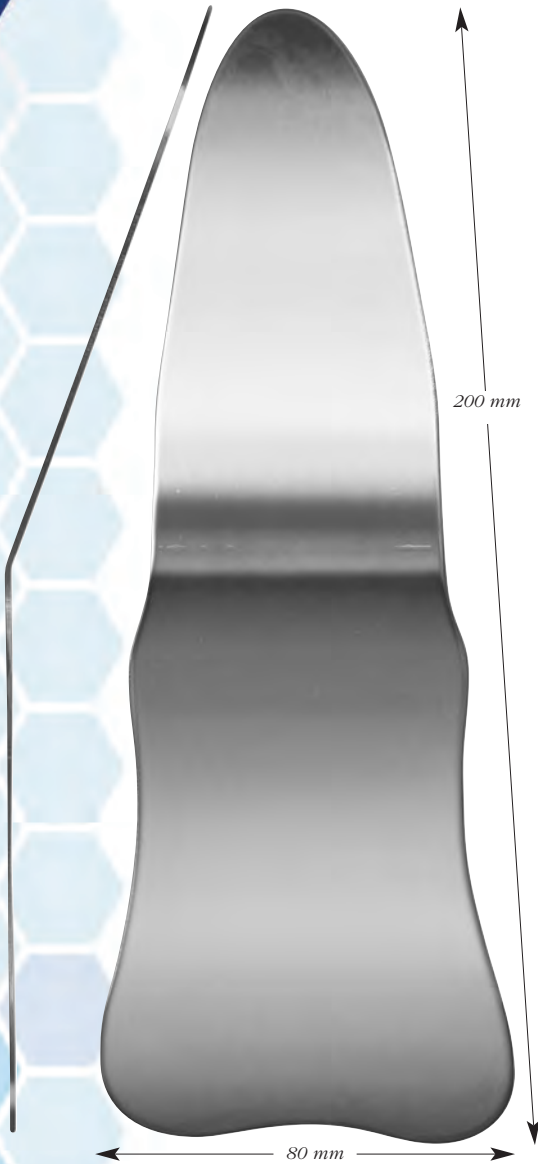

**HSJ 123-00**  
sterilisierbar / sterilizable

**Intraoraler Spiegel aus Metall**  
**Intraoral mirrors from metal**  
CE



**HSJ 154-01**  
40 x 163 mm  
sterilisierbar / sterilizable  
CE



**HSJ 155-02**  
69 x 163 mm  
sterilisierbar / sterilizable  
CE



**HSJ 157-00**  
sterilisierbar / sterilizable



**HSJ 156-03**  
79 x 163 mm  
sterilisierbar / sterilizable  
CE

Griffhülle aus Silikon, einzeln, blau, für Fotospiegel HSJ 154-01 bis HSJ 156-03  
Silicone handle, single, blue, for photo mirrors HSJ 154-01 to HSJ 156-03

- ☑ Fotospiegel aus Metall mit aufwendiger Rhodiumbeschichtung
  - ☑ ideal für verzerrungsfreie intraorale Aufnahmen
  - ☑ langlebig und robust
  - ☑ bei 134° C sterilisierbar
  - ☑ mit abnehmbarer Griffhülle aus Silikon
- ☑ Photo mirror from metal with elaborate rhodium coating
  - ☑ ideal for distortion-free intraoral images
  - ☑ durable and robust
  - ☑ sterilizable at 134° C
  - ☑ with removable silicone handle

Alle mit CE gekennzeichneten Produkte sind Medizinprodukte. | All products marked with CE are medical devices.

**Doppelseitiger Fotospiegel aus Glas, 3mm stark**

- ✓ Die Spiegel können im Heißluftsterilisator bis 180° C, im Autoklav bis 130° C oder im Thermodesinfektor bis 105° C behandelt werden.
- ✓ Der abnehmbare Silikongriff ist autoklavierbar.
- ✓ Die Beschichtung ist aus einem extrem glänzenden Floatglas.
- ✓ Die Spiegel bieten eine nahezu 100 %ige Reflexionsfarbtreue und sind korrosionsbeständig.

**Double-sided photo mirror from glass, 3mm thick**

- ✓ The mirrors can be treated in a hot air sterilizer up to 180° C, in an autoclave up to 130° C or in a thermo disinfecter up to 105° C.
- ✓ The removable silicone handle is autoclavable.
- ✓ The coating is made from an extremely glossy float glass.
- ✓ The mirrors provide almost 100% reflection colour fidelity and are corrosion resistant.



**HSM 114-18**  
18,6 x 8,5 x 1,3 cm  
CE

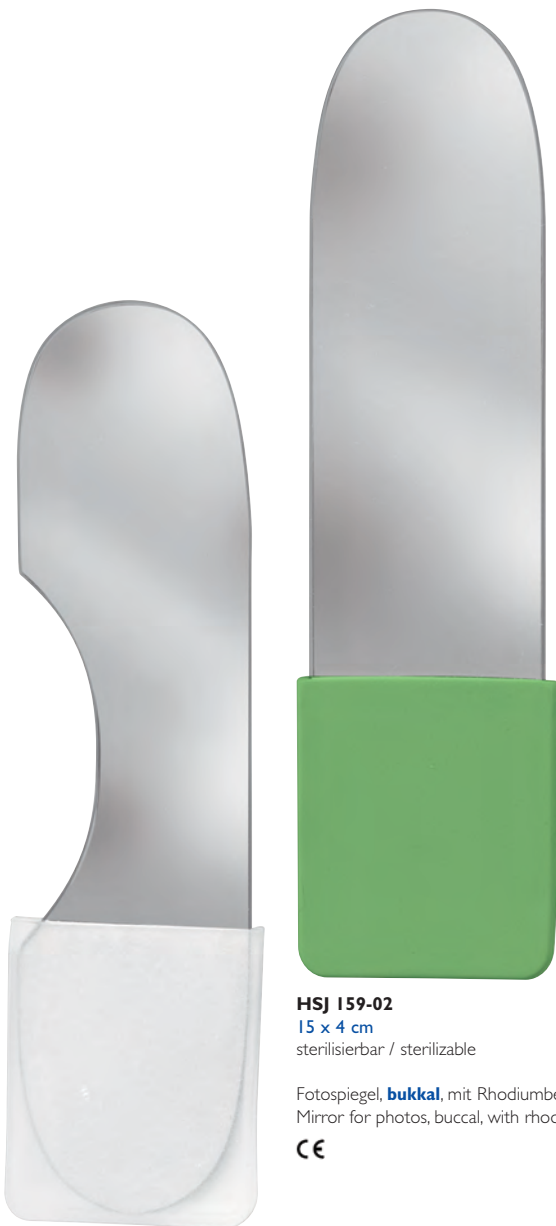

**HSJ 159-02**  
15 x 4 cm  
sterilisierbar / sterilizable

Fotospiegel, **bukkal**, mit Rhodiumbeschichtung  
Mirror for photos, buccal, with rhodium coating

CE



**HSJ 159-03**  
7,5 x 10,5 cm  
sterilisierbar / sterilizable

Fotospiegel, **okklusal**, mit Rhodiumbeschichtung  
Mirror for photos, occlusal, with rhodium coating

CE

**HSJ 159-01**  
7,5 x 6 cm  
sterilisierbar / sterilizable

Fotospiegel, **lingual**, mit Rhodiumbeschichtung  
Mirror for photos, lingual, with rhodium coating

CE

- ✓ Die inneren Silikonstreifen üben keinen Druck auf die Spiegel aus, was ein vollständiges Eindringen der Wasch- und Desinfektionslösungen ermöglicht.
- ✓ Diese Kassetten sind aus hochwertigen Materialien gefertigt (Edelstahl und Silikon).
- ✓ Diese Kassetten wurden für die Verwendung mit allen Desinfektions- und Reinigungslösungen sowie in Ultraschallbädern oder Reinigungs- und Desinfektionsgeräten entwickelt.
- ✓ Autoklavierbar bis 134 ° C
- ✓ Da sie sehr dünn sind (1,3 cm), nehmen diese Kassetten bei jedem Reinigungsprozess sehr wenig Platz.
- ✓ The internal silicone strips put no pressure on the mirrors which allow complete penetration by the washing and disinfection solutions.
- ✓ These cassettes are made of high performance materials (stainless steel and silicone).
- ✓ These cassettes have been designed for use with all disinfection and cleaning solutions such as ultrasonic baths or washer disinfectors.
- ✓ Autoclavable up to 134°C
- ✓ Because they are very thin (1,3cm) these cassettes take up very little room in any process.

*wironit*

- ✓ nichtrostend
- ✓ antimagnetisch
- ✓ säurebeständig
- ✓ formschön
- ✓ leicht in der Hand
- ✓ von langer Lebensdauer
- ✓ rust resistant
- ✓ anti-magnetic
- ✓ acid resistant
- ✓ beautifully designed
- ✓ light in the hand
- ✓ unlimited durability



**HWC 016-04  
College**  
150 mm  
glatt  
smooth

CE



**HWC 017-05  
College**  
150 mm  
gerieft  
serrated

CE



**HWC 019-12  
Meriam**  
150 mm  
gerieft  
serrated

CE

Zahnpinzetten aus WIRONIT  
Tweezers from WIRONIT



**HSC 012-05  
fig. 5  
London-College**  
gerieft  
serrated

CE

**HSC 020-05  
London-College**  
einfache Ausführung, gerieft  
simple pattern, serrated

CE

**HSC 021-09  
Meriam**  
einfache Ausführung, gerieft  
simple pattern, serrated

CE

**HSC 024-09  
Meriam**  
160 mm  
gerieft  
serrated

CE

Zahnpinzetten aus rostfreiem Stahl  
Tweezers from stainless steel

**ARQUATUS** line



**HWC 030-54**  
College  
150 mm

CE

Zahnpinzetten mit diamantierten Spitzen  
Cotton tweezers with diamond tips

**HWC 031-54**  
Meriam  
150 mm

CE



**HSJ 101-00**

Mundspiegelgriff, hohl  
Mouth mirror handle, hollow

CE



**HSC 025-05**

Pinzette, College  
Tweezers, College  
CE



**HSJ 008-42**

Zahnsonde  
Probe  
CE



**HSJ 100-03**

Diagnostik-Set, 3-teilig, im Etui  
Diagnostic set, 3 pieces, in a box  
CE

**HSJ 100-03**

Diagnostik Set, bestehend aus:  
Diagnostics set, consisting of:

**SET**

**HSJ 101-00**

Mundspiegelgriff, hohl  
Mouth mirror handle, hollow

**HSC 025-05**

Pinzette, College  
Tweezers, College

**HSJ 008-42**

Zahnsonde  
Probe



**HSJ 140-04**  
fig. 4  
22 mm  
plan  
plane  
CE



**HWJ 091-00**  
hohl  
hollow  
CE



**HSJ 004-42**  
fig. 42  
CE



**HSC 012-05**  
fig. 5  
London-College  
CE



**HWM 107-05**  
180 x 60 x 25 mm  
CE



**HSJ 160-00**

**HSJ 100-05**  
Diagnostik Set, bestehend aus:  
Diagnostics set, consisting of:

**HSJ 140-04**  
fig. 4  
22 mm  
"HAMSÖ"-Mundspiegel  
(1 Verpackungseinheit = 1 Stück)  
absolut rostsicher, geeignet für alle Reinigungs-  
und Sterilisationsarten  
"HAMSÖ" mouth mirrors  
(1 package = 1 pcs.)  
absolutely non-rusting, suitable for all kinds of  
cleaning and sterilization

**HWJ 091-00**  
Mundspiegelgriffe aus WIRONIT, hohl  
Mouth mirror handles from WIRONIT, hollow

**HSJ 004-42**  
fig. 42  
Zahnsonden, einendig, mit Rundgriff  
Probes and explorers, single ended, with round handle

**HSJ 160-00**  
Serviettenhalter; Länge verstellbar  
Napkin holder; length adjustable

**HSC 012-05**  
fig. 5  
London-College  
Zahnpinzetten, gerieft  
Tweezers, serrated

**HWM 107-05**  
180 x 60 x 25 mm  
Sterilisier- und Waschkassetten  
(für 5 Instrumente - mit blauem Silikon -  
sterilisierbar)  
Sterilising and washing cassettes  
(for 5 instruments - with blue silicone -  
sterilizable)

**SET**



**Zahnzangen, englische Form, mit Teflonscheibe im Schloss für ein dauerhaft leichtes und gleichmäßiges Öffnen und Schließen**  
**Extracting forceps, English pattern, with Teflon disc in the lock for a permanent easy and smooth opening and closing**

FDI 11-13 21-23  
321 | 123



**HSA 001-01**  
fig. 1  
obere Schneide- u. Eckzähne  
upper centrals and canines  
CE

FDI 14,15 24,25  
54 | 45



**HSA 004-07**  
fig. 7  
obere Prämolaren  
upper premolars  
CE

FDI 16, 17, 18  
876

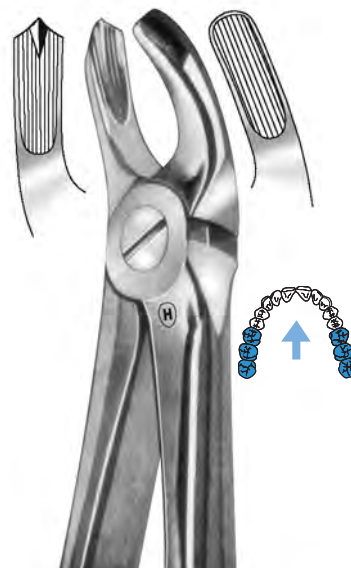

**HSA 005-17**  
fig. 17  
obere Molaren, rechts  
upper molars, right  
CE

FDI 26, 27, 28  
678

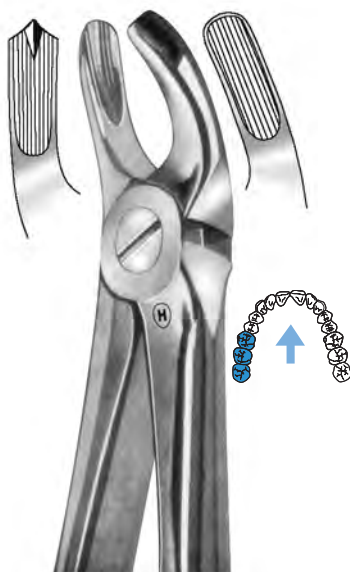

**HSA 006-18**  
fig. 18  
obere Molaren, links  
upper molars, left  
CE



**HSA 010-29**  
fig. 29  
obere Wurzeln  
upper roots  
CE



**HSA 014-49**  
fig. 49  
obere Wurzeln  
upper roots  
CE

**Extraktion**  
**Extraction**

**Zahnzangen, englische Form, mit Teflonscheibe im Schloss für ein dauerhaft leichtes und gleichmäßiges Öffnen und Schließen**  
**Extracting forceps, English pattern, with Teflon disc in the lock for a permanent easy and smooth opening and closing**



**HSA 016-51**  
*fig. 51*  
obere Wurzeln  
upper roots

CE



**HSA 017-51**  
*fig. 51A*  
obere Wurzeln  
upper roots

CE



**HSA 019-52**  
*fig. 52*  
obere Wurzeln  
upper roots

CE

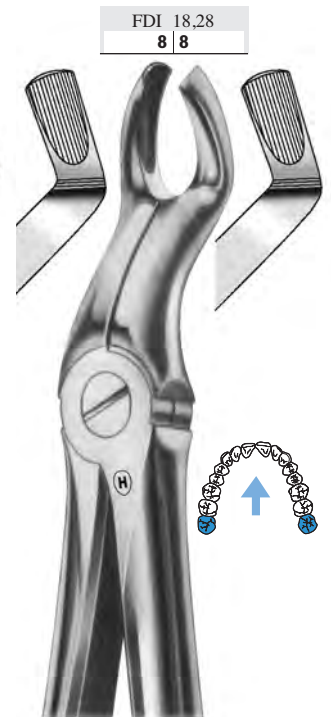

FDI 18,28  
8 | 8

**HSA 023-67**  
*fig. 67A*  
obere dritte Molaren  
upper third molars

CE

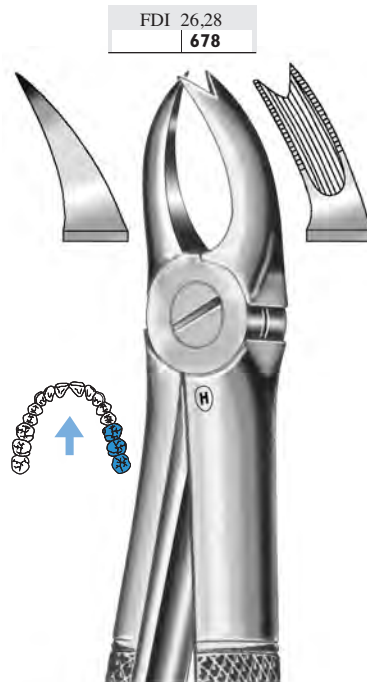

FDI 26,28  
678

**HSA 026-89**  
*fig. 89*  
obere Molarena, rechts  
upper molars right

CE

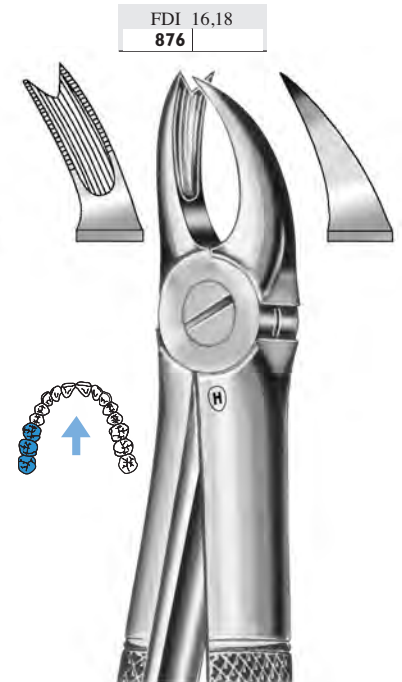

FDI 16,18  
876

**HSA 027-90**  
*fig. 90*  
obere Molaren, links  
upper molars, left

CE

**Zahnzangen, englische Form, mit Teflonscheibe im Schloss für ein dauerhaft leichtes und gleichmäßiges Öffnen und Schließen**  
**Extracting forceps, English pattern, with Teflon disc in the lock for a permanent easy and smooth opening and closing**



**HSA 050-04**  
*fig. 4*  
 untere Schneide- u. Eckzähne  
 lower incisors and canines  
**CE**



**54 | 45**  
 FDI 34,35 44,45

**HSA 052-13**  
*fig. 13*  
 untere Prämolaren  
 lower premolars  
**CE**



**76 | 67**  
 FDI 36,37 46,47

**HSA 056-22**  
*fig. 22*  
 untere Molaren  
 lower molars  
**CE**

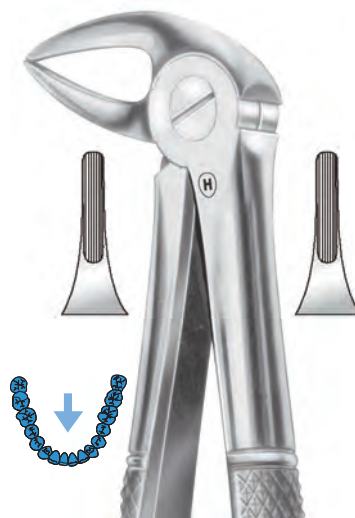

**HSA 060-33**  
*fig. 33*  
 untere Wurzeln  
 lower roots  
**CE**

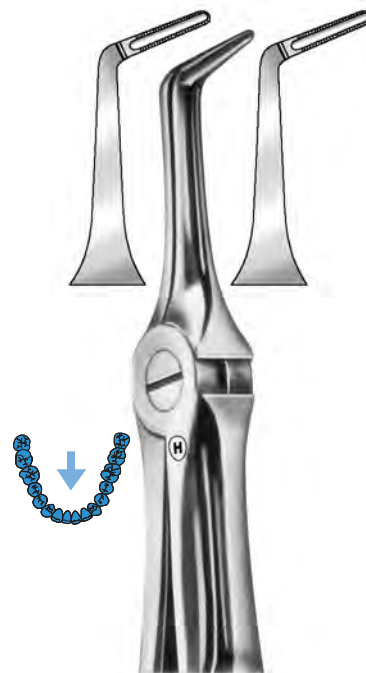

**HSA 065-46**  
*fig. 46*  
 untere Wurzeln  
 lower roots  
**CE**

**Extraktion**  
**Extraction**

**Zahnzangen, englische Form**, mit Teflonscheibe im Schloss für ein dauerhaft leichtes und gleichmäßiges Öffnen und Schließen  
**Extracting forceps, English pattern**, with Teflon disc in the lock for a permanent easy and smooth opening and closing

**76 | 67**  
FDI 36,37 46,47



**HSA 067-73**  
*fig. 73*  
untere Molaren  
lower molars  
CE

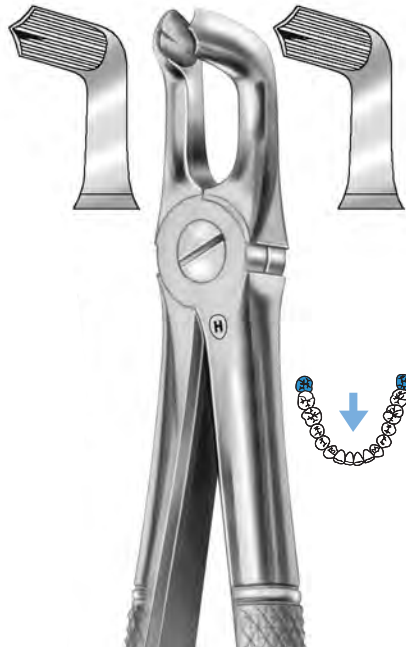

**HSA 071-79**  
*fig. 79*  
untere dritte Molaren  
lower third molars  
CE

**76 | 67**  
FDI 36,37 46,47



**HSA 073-86**  
*fig. 86A*  
untere Molaren  
lower molars  
CE

**876**  
FDI 46-48

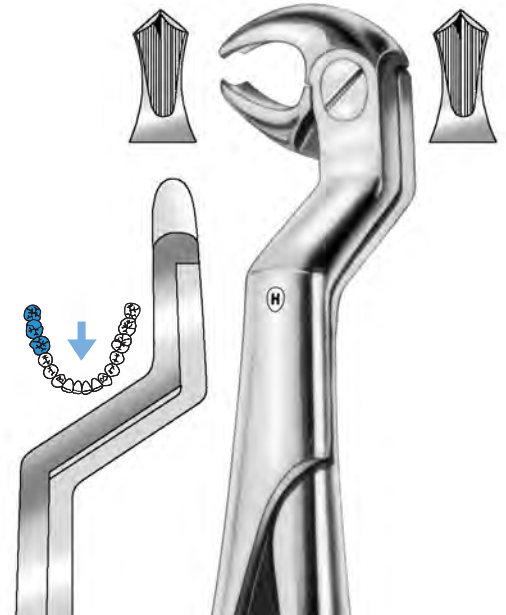

**HSA 080-22**  
**Routurier** *fig. 22 1/2 L*  
untere Molaren u. Weisheitszähne, links  
lower molars and wisdoms, left  
CE

**678**  
FDI 36-38

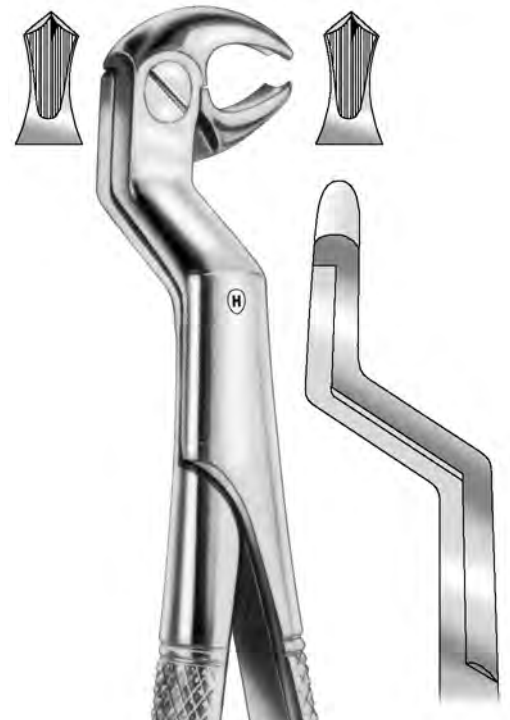

**HSA 081-22**  
**Routurier** *fig. 22 1/2 R*  
untere Molaren u. Weisheitszähne, rechts  
lower molars and wisdoms, right  
CE

**Zahnzangen, englische Form, mit Haftprofil, mit Teflonscheibe im Schloss für ein dauerhaft leichtes und gleichmäßiges Öffnen und Schließen**  
**Extracting forceps, English pattern, with nonslip jaws, with Teflon disc in the lock for a permanent easy and smooth opening and closing**



**NONSLIP**

FDI 11-13 21-23  
321 | 123



**HSA 100-01**  
fig. 1  
obere Schneide u. Eckzähne  
upper centrals and canines  
CE

FDI 11,12 21,22  
21 | 12



**HSA 101-02**  
fig. 2  
obere Schneide u. Eckzähne  
upper laterals and canines  
CE

FDI 14,15 24,25  
54 | 45



**HSA 102-07**  
fig. 7  
obere Prämolaren  
upper premolars  
CE

FDI 26,28  
678



**HSA 103-17**  
fig. 17  
obere Molaren, rechts  
upper molars, right  
CE

FDI 16,18  
876

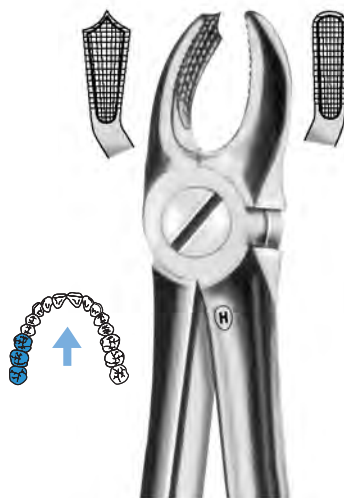

**HSA 104-18**  
fig. 18  
obere Molaren, links  
upper molars, left  
CE



**HSA 105-51**  
fig. 51  
obere Wurzeln  
upper roots  
CE

Alle mit CE gekennzeichneten Produkte sind Medizinprodukte. | All products marked with CE are medical devices.

**Extraktion  
Extraction**

**Zahnzangen, englische Form, mit Haftprofil, mit Teflonscheibe im Schloss für ein dauerhaft leichtes und gleichmäßiges Öffnen und Schließen**  
**Extracting forceps, English pattern, with nonslip jaws, with Teflon disc in the lock for a permanent easy and smooth opening and closing**



**NONSLIP**



**HSA 106-51**  
*fig. 51A*  
 obere Wurzeln  
 upper roots  
 CE

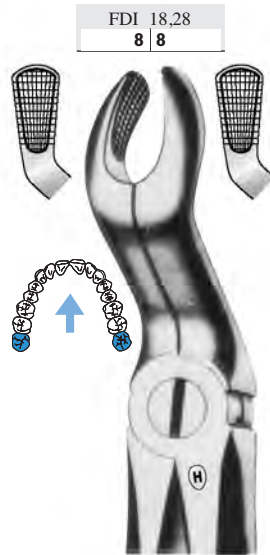

FDI 18,28  
 8 | 8

**HSA 107-67**  
*fig. 67*  
 obere dritte Molaren  
 upper third molars  
 CE



54 | 45  
 FDI 34,35 44,45

**HSA 111-13**  
*fig. 13*  
 untere Prämolaren  
 lower premolars  
 CE



**HSA 113-22**  
*fig. 22*  
 untere Molaren  
 lower molars  
 CE



**HSA 114-33**  
*fig. 33*  
 untere Wurzeln  
 lower roots  
 CE



**HSA 115-33**  
*fig. 33 A*  
 untere Wurzeln  
 lower roots  
 CE

Alle mit CE gekennzeichneten Produkte sind Medizinprodukte. | All products marked with CE are medical devices.

**Zahnzangen, englische Form, mit Haftprofil**, mit Teflonscheibe im Schloss für ein dauerhaft leichtes und gleichmäßiges Öffnen und Schließen  
**Extracting forceps, English pattern, with nonslip jaws**, with Teflon disc in the lock for a permanent easy and smooth opening and closing

**Spezialzahnzangen**

Die sehr schlank gearbeiteten Branchen erlauben ein sicheres und tieferes Greifen am Zahnhals. Zur Unterstützung einer guten Rotationsbewegung – auch beim Eingreifen bis ins Knochenfach – sind die Branchen zu jeder Seite stark abgeflacht.

**Special extracting forceps**

The very delicate jaws permit a safer and deeper seize at the dental neck. For the support of a good rotation – also when seizing down to the bone – the jaws are extremely flattened at each side.



**NONSLIP**

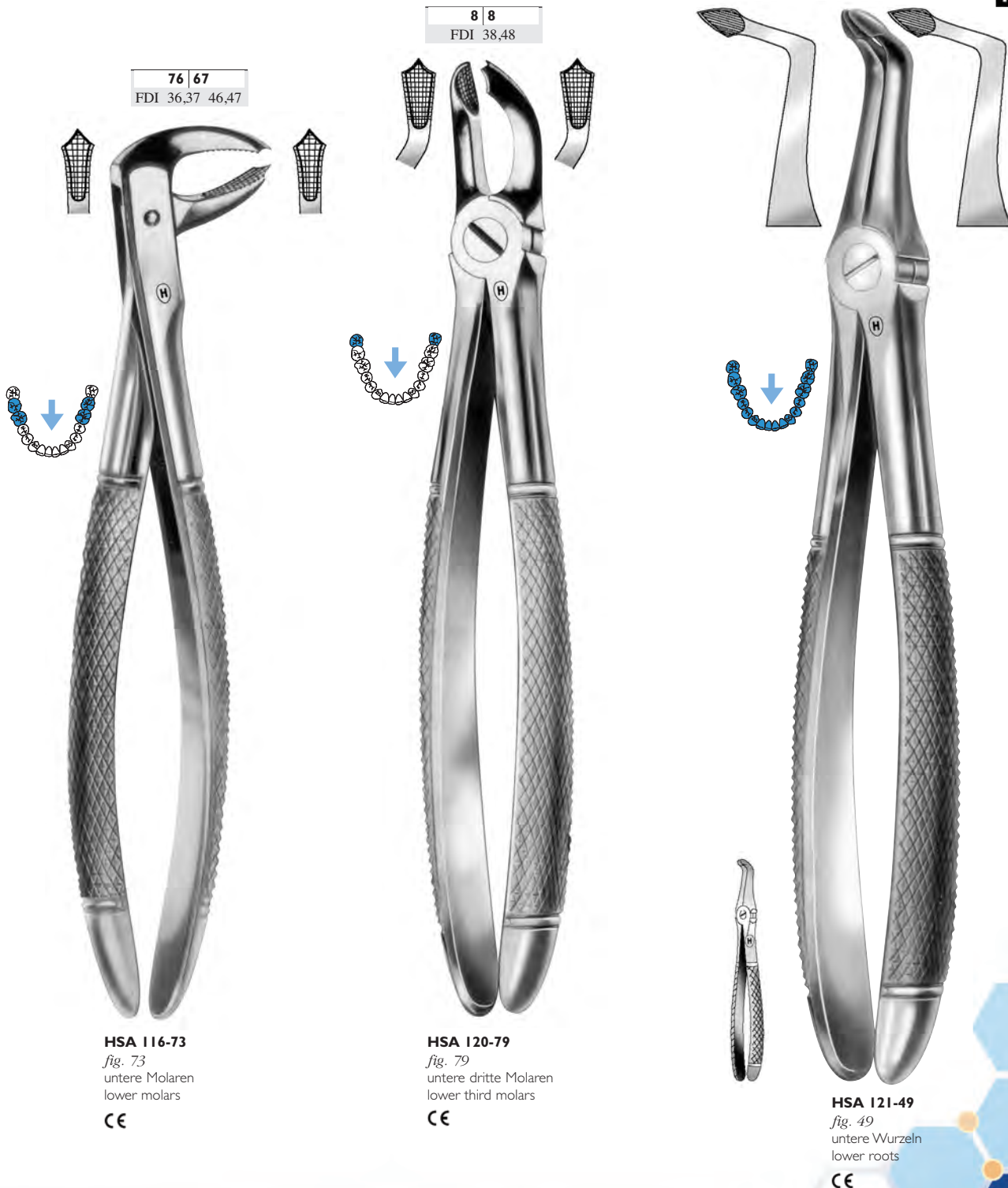

**HSA 116-73**  
fig. 73  
untere Molaren  
lower molars  
CE

**HSA 120-79**  
fig. 79  
untere dritte Molaren  
lower third molars  
CE

**HSA 121-49**  
fig. 49  
untere Wurzeln  
lower roots  
CE

Alle mit CE gekennzeichneten Produkte sind Medizinprodukte. | All products marked with CE are medical devices.

## Extraktion Extraction

**Zahnzangen, englische Form, mit Haftprofil,** mit Teflonscheibe im Schloss für ein dauerhaft leichtes und gleichmäßiges Öffnen und Schließen  
**Extracting forceps, English pattern, with nonslip jaws,** with Teflon disc in the lock for a permanent easy and smooth opening and closing

### HSA 125-15

Extraktions-Set für Einsteiger, komplett, bestehend aus 2 Sets **für Ober- und Unterkiefer**  
 (HSA 126-08 + HSA 127-07) im Aluminium-Tray  
 Inhalt: 10 Zahnzangen englische Form mit Haftprofil-Maul und 5 Wurzelheber

Extraction set for beginners, complete, consisting of 2 sets **for upper and lower jaws**  
 (HSA 126-08 + HSA 127-07) in an Aluminium-tray  
 Contents: 10 extracting forceps English pattern with non-slip jaws and 5 root elevators

CE

SET



NONSLIP



Alle mit CE gekennzeichneten Produkte sind Medizinprodukte. | All products marked with CE are medical devices.



Zahnzangen, englische Form, mit Haftprofil, mit Teflonscheibe im Schloss für ein dauerhaft leichtes und gleichmäßiges Öffnen und Schließen  
 Extracting forceps, English pattern, with nonslip jaws, with Teflon disc in the lock for a permanent easy and smooth opening and closing

FDI 11-13 21-23  
321 | 123



**HSA 100-01**  
fig. 1  
obere Schneide- und Eckzähne  
upper centrals and canines

CE

FDI 14,15 24,25  
54 | 45

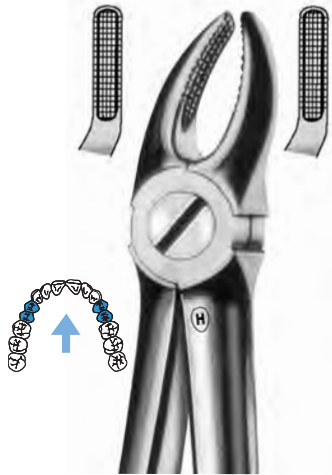

**HSA 102-07**  
fig. 7  
obere Prämolaren  
upper premolars

CE

FDI 26,28  
678

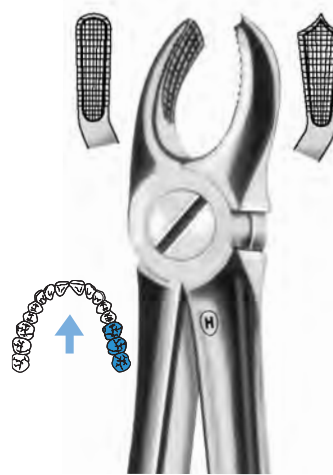

**HSA 103-17**  
fig. 17  
obere Molaren, rechts  
upper molars, right

CE

FDI 16,18  
876

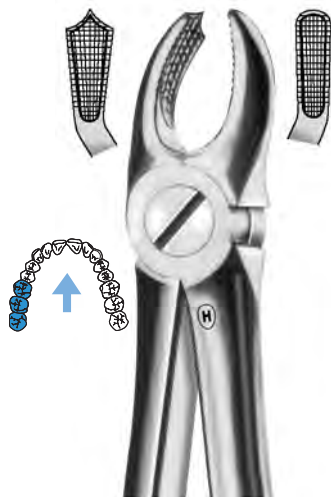

**HSA 104-18**  
fig. 18  
obere Molaren, links  
upper molars, left

CE

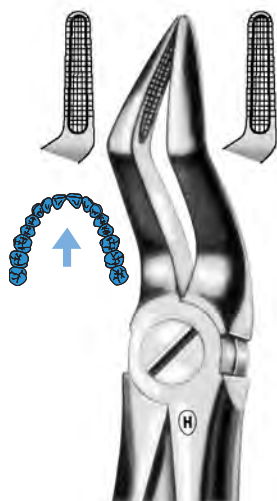

**HSA 105-51**  
fig. 51  
obere Wurzeln  
upper roots

CE

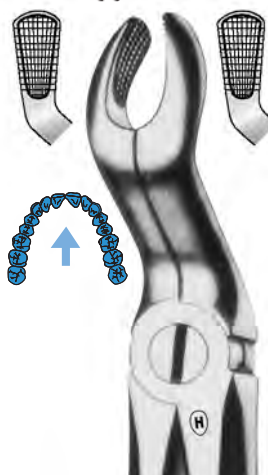

**HSA 107-67**  
fig. 67  
dritte Molaren  
third molars

CE



**HSA 648-39**  
fig. 39  
**Cryer**  
Wurzelheber  
untere Wurzeln, links  
Root elevator  
lower roots, left

CE



**HSA 648-40**  
fig. 40  
**Cryer**  
Wurzelheber  
untere Wurzeln, rechts  
Root elevator  
lower roots, right

CE

**HSA 126-08**

Extraktions-Set für Einsteiger für Oberkiefer im Aluminium-Tray  
 Inhalt: 6 Zahnzangen englische Form mit Haftprofil-Maul und 2 Wurzelheber  
 Extraction set for beginners for upper jaws in an Aluminium-tray  
 Contents: 6 extracting forceps English pattern with non-slip jaws and 2 root elevators

CE

Alle mit CE gekennzeichneten Produkte sind Medizinprodukte. | All products marked with CE are medical devices.

**Zahnzangen, englische Form, mit Haftprofil**, mit Teflonscheibe im Schloss für ein dauerhaft leichtes und gleichmäßiges Öffnen und Schließen  
**Extracting forceps, English pattern, with nonslip jaws**, with Teflon disc in the lock for a permanent easy and smooth opening and closing

HSA 127-07

Extraktions-Set für Einsteiger **für Unterkiefer** im Aluminium-Tray  
 Inhalt: 4 Zahnzangen englische Form mit Haftprofil-Maul und 3 Wurzelheber  
 Extraction set for beginners **for lower jaws** in an Aluminium-tray  
 Contents: 4 extracting forceps English pattern with non-slip jaws and 3 root elevators

SET



NONSLIP

54 | 45  
FDI 34,35 44,45

**HSA 111-13**  
 fig. 13  
 untere Prämolaren  
 lower premolars

CE

76 | 67  
FDI 36,37 46,47

**HSA 113-22**  
 fig. 22  
 untere Molaren  
 lower molars

CE

8 | 8  
FDI 38,48

**HSA 114-33**  
 fig. 33  
 untere Wurzeln  
 lower roots

CE

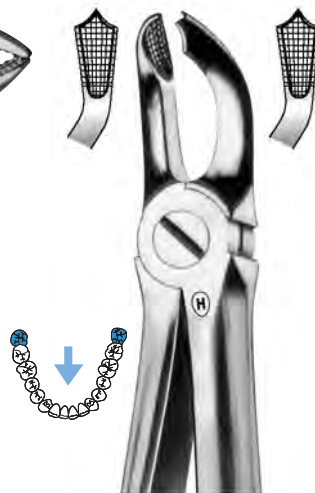

**HSA 120-79**  
 fig. 79  
 untere dritte Molaren  
 lower third molars

CE



**HSA 628-02**  
 fig. 2/3 (L/R)  
**Lindenblatt**  
 kombinierter Zahn- und Wurzelheber;  
 rechts und links in einem Instrument  
 combined tooth and root elevator;  
 right and left with one instrument

CE

**HSA 648-39**  
 fig. 39  
**Cryer**  
 untere Wurzeln, links  
 lower roots, left

CE

**HSA 648-40**  
 fig. 40  
**Cryer**  
 untere Wurzeln, rechts  
 lower roots, right

CE

Zahnzangen, englische Form, mit Haftprofil, mit Teflonscheibe im Schloss für ein dauerhaft leichtes und gleichmäßiges Öffnen und Schließen  
 Extracting forceps, English pattern, with nonslip jaws, with Teflon disc in the lock for a permanent easy and smooth opening and closing



**NONSLIP**



**HSA 208-06**  
 Deve 606D  
 untere Wurzeln und Stifte  
**diamantiert**  
 lower roots and pins  
**diamond coated**

CE



**HSA 138-51**  
 fig. 51A  
 obere Wurzeln  
 upper roots

CE



**76 | 67**  
 FDI 36,37 46,47

**HSA 161-86**  
 fig. 86A  
 untere Molaren  
 lower molars  
 CE

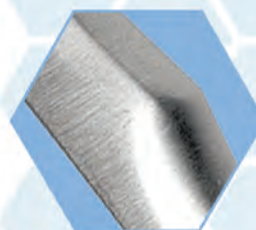

## GRIFFI

- ✓ die griffigen, handgerechten Zahnzangen von HAMMACHER
- ✓ perfekt in der Hygiene

## GRIFFI

- ✓ the handy extracting forceps of HAMMACHER
- ✓ perfect for the hygiene

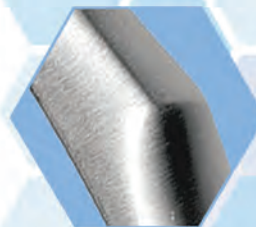

**Extraktion  
Extraction**

**Zahnzangen für Kinder, englische Form, mit Haftprofil, mit Teflonscheibe im Schloss für ein dauerhaft leichtes und gleichmäßiges Öffnen und Schließen**  
**Extracting forceps for children, English pattern, with nonslip jaws, with Teflon disc in the lock for a permanent easy and smooth opening and closing**

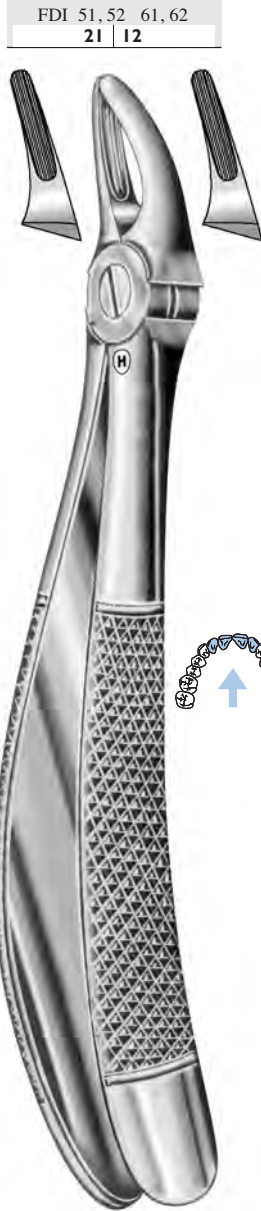

**HSA 321-30**  
fig. 30S  
obere Prämolaren u. Wurzeln  
upper bicuspids and roots  
CE



**HSA 320-29**  
fig. 29S  
obere Wurzeln  
upper roots  
CE



**HSA 322-37**  
fig. 37  
obere Schneide- u. Eckzähne  
upper centrals and canines  
CE

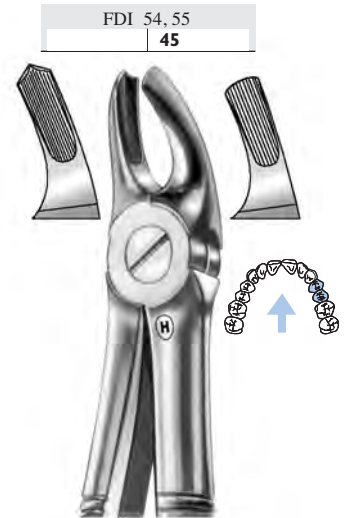

**HSA 325-39**  
fig. 39R  
obere Molaren, rechts  
upper molars, right  
CE

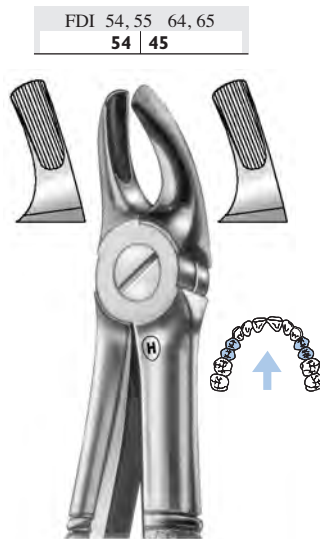

**HSA 323-39**  
fig. 39  
obere Molaren  
upper molars  
CE



**HSA 324-39**  
fig. 39A  
obere Molaren  
upper molars  
CE

**Zahnzangen für Kinder, englische Form, mit Haftprofil, mit Teflonscheibe im Schloss für ein dauerhaft leichtes und gleichmäßiges Öffnen und Schließen**  
**Extracting forceps for children, English pattern, with nonslip jaws, with Teflon disc in the lock for a permanent easy and smooth opening and closing**

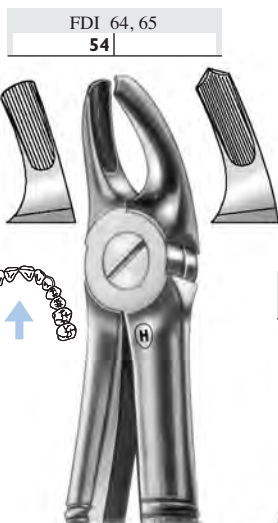

FDI 64, 65  
54 | 45



FDI 51, 52, 53, 54, 55 61, 62, 63, 64, 65  
54321 | 12345

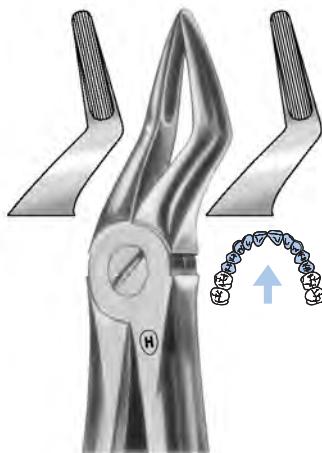

**HSA 327-51**  
fig. 51S  
obere Wurzeln  
upper roots  
CE



FDI 74, 75 84, 85  
54 | 45



**HSA 331-22**  
fig. 22S  
untere Molaren  
lower molars  
CE



for  
Children



- ✓ mit Haftprofil
- ✓ with nonslip jaws



**HSA 330-13**  
fig. 13S  
untere Prämolaren  
lower premolars  
CE

FDI 71, 72, 73, 74, 75 81, 82, 83, 84, 85  
54321 | 12345



**HSA 332-33**  
fig. 33S  
untere Wurzeln  
lower roots  
CE

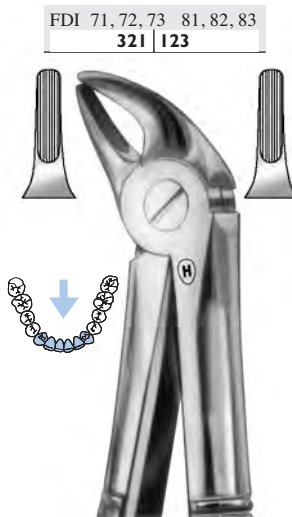

FDI 71, 72, 73 81, 82, 83  
321 | 123

**HSA 333-38**  
fig. 38  
untere Schneide- u. Eckzähne  
lower centrals and canines  
CE

## Zahnzangen für Kinder nach Klein mit Feder Extracting forceps for children according to Klein with spring

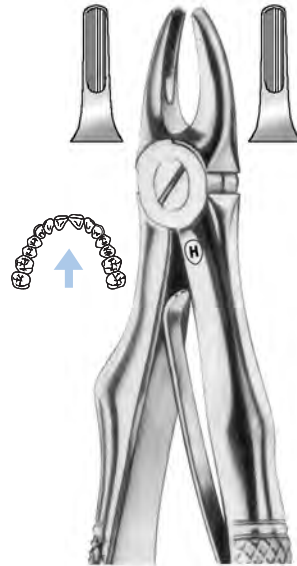

**HSA 340-01**  
*fig. 1*  
obere Schneidezähne  
upper incisors  
CE

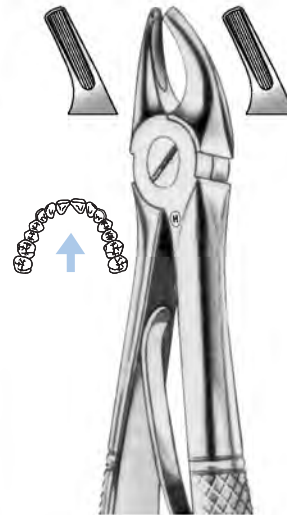

**HSA 341-02**  
*fig. 2*  
obere Prämolaren  
upper premolars  
CE

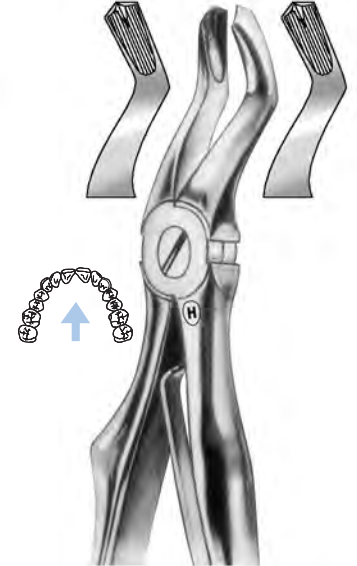

**HSA 342-03**  
*fig. 3*  
obere Molaren  
upper molars  
CE

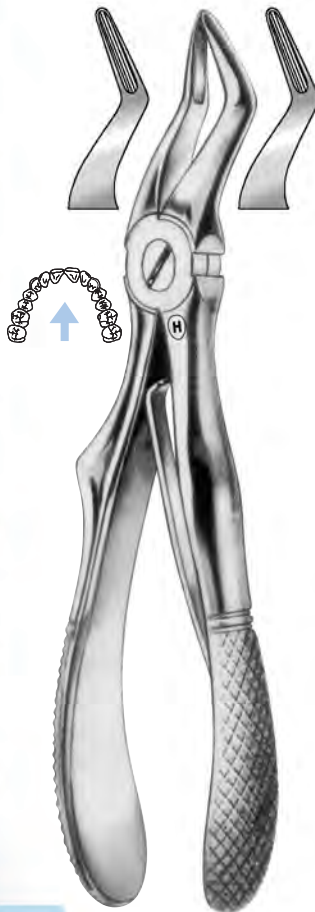

**HSA 343-04**  
*fig. 4*  
obere Wurzeln  
upper roots  
CE



**HSA 344-05**  
*fig. 5*  
untere Schneidezähne  
lower incisors  
CE



**HSA 345-06**  
*fig. 6*  
untere Molaren  
lower molars  
CE



**HSA 346-07**  
*fig. 7*  
untere Wurzeln  
lower roots  
CE

Zahnzangen für Kinder nach Klein mit Feder  
Extracting forceps for children according to Klein with spring

**ARQUATUS** line



**HSA 350-01**  
*fig. 1*

obere Schneidezähne  
upper incisors

CE



**HSA 351-02**  
*fig. 2*

obere Prämolaren  
upper premolars

CE



**HSA 352-03**  
*fig. 3*

obere Molaren  
upper molars

CE

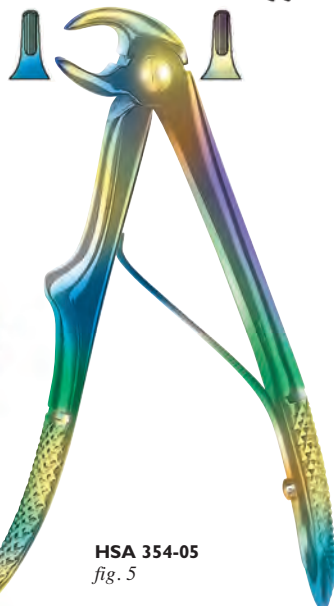

**HSA 354-05**  
*fig. 5*

untere Schneidezähne  
lower incisors

CE



**HSA 355-06**  
*fig. 6*

untere Molaren  
lower molars

CE



**HSA 353-04**  
*fig. 4*

obere Wurzeln  
upper roots

CE

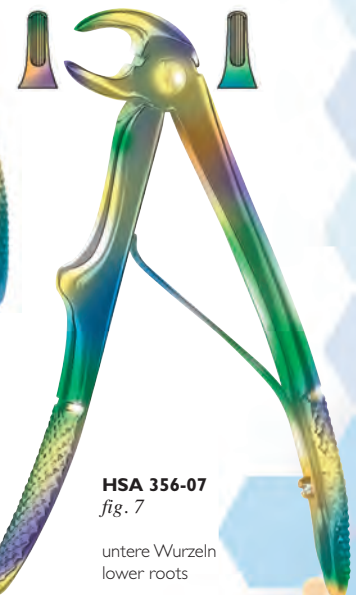

**HSA 356-07**  
*fig. 7*

untere Wurzeln  
lower roots

CE

Kinderzahnzangen nach Klein mit Feder  
Extracting forceps for children according to Klein with spring

Alle mit CE gekennzeichneten Produkte sind Medizinprodukte. | All products marked with CE are medical devices.

# SERVICE

## wird bei uns groß geschrieben!

We consider SERVICE one of the main aspects of our philosophy!

Zu unseren Leistungen gehört selbstverständlich auch ein Reparaturservice,

der unter anderem folgende Arbeiten umfaßt:

As part of our service, we offer our customers a repair service,  
including the following work processes:



**Diamantierung**  
Diamond coating

Diamantierung und Nachdiamantierung von  
Zahnzangen, Pinzetten, Teleskopzangen, etc., ...  
Diamond coating and re-coating of  
extracting forceps, telescope crown pliers, etc.,...



**Schärfen**  
Tool sharpening

Schärfen und Nachschleifen von Scheren, Skalpelln  
und sonstigen schneidenden Instrumenten  
Sharpening and regrinding of scissors, scalpels  
and other cutting instruments



**Oberflächenbearbeitung**  
Surface finishing

Oberflächenbearbeitung der Instrumente, wie:  
Mattieren, Polieren, Verchromen und Vergolden  
Surface finishing of instruments, such as  
matt finishing, polishing, chrome and gold plating



**Sonderanfertigung**  
Customised Instruments

Wir produzieren für Sie in Sonderanfertigung Instrumente  
nach Muster, Skizze oder ähnlichem  
For our customers, we manufacture custom-made instruments  
to specification from your samples, drawings etc.

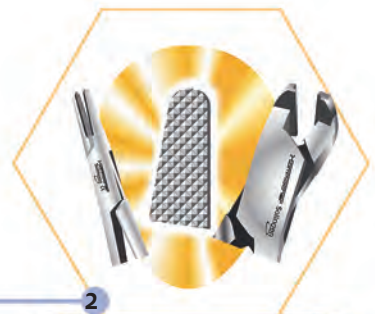

**TC-Einsätze**  
TC-inserts

Erneuerung von Hartmetall-Einlagen für  
Nadelhalter und technische Zangen  
Replacement of tungsten carbide inserts for  
needle holders and technical pliers



**Nacharbeit**  
Refinishing

Komplettes Nacharbeiten älterer Instrumente, wie:  
Nachpolieren, Richten, gängig machen und Entrosten  
Complete refinishing of old instruments, such as  
surface redressing, alignment, rust removal and making instruments patent

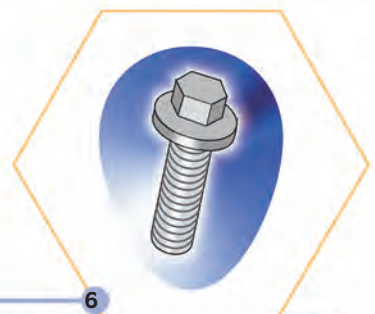

**Ersatz**  
Replacement of parts

Ersatz von Schrauben, Stiften oder Nieten  
Replacement of screws, pins and rivets



Zahnzangen, englische Form, mit Haftprofil, mit Teflonscheibe im Schloss für ein dauerhaft leichtes und gleichmäßiges Öffnen und Schließen  
 Extracting forceps, English pattern, with nonslip jaws, with Teflon disc in the lock for a permanent easy and smooth opening and closing

FDI 11-13 21-23  
321 | 123



**HSA 550-01**  
fig. 1  
obere mittlere Schneide- u. Eckzähne  
upper centrals and canines

CE

FDI 12,14 22,24  
42 | 24



**HSA 551-02**  
fig. 2  
obere seitliche Schneidezähne u. Prämolaren  
upper centrals and bicuspidis

CE

FDI 14,15 24,25  
54 | 45

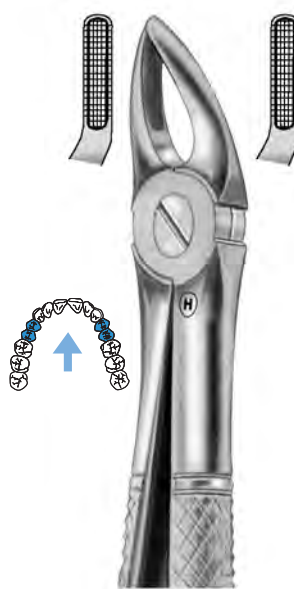

**HSA 552-07**  
fig. 7  
obere Prämolaren, beide Seiten  
upper bicuspidis, either side

CE

FDI 16-18  
678



**HSA 553-17**  
fig. 17  
obere Molaren, rechts  
upper molars, right

CE

FDI 26,28  
876



**HSA 554-18**  
fig. 18  
obere Molaren, links  
upper molars, left

CE

TOP  
HANDY

- ✓ kleiner und leichter
- ✓ smaller and lighter

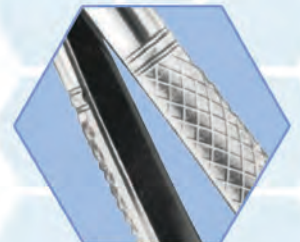

- ✓ mit Haftprofil
- ✓ with nonslip jaws

Zahnzangen, englische Form, mit Haftprofil, mit Teflonscheibe im Schloss für ein dauerhaft leichtes und gleichmäßiges Öffnen und Schließen  
 Extracting forceps, English pattern, with nonslip jaws, with Teflon disc in the lock for a permanent easy and smooth opening and closing

TOP  
HANDY

- ✓ kleiner und leichter
- ✓ smaller and lighter

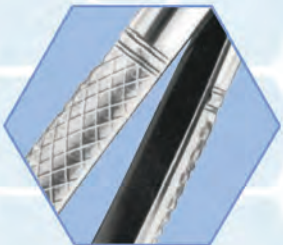

- ✓ mit Haftprofil
- ✓ with nonslip jaws



**HSA 555-29**  
fig. 29  
obere Wurzeln  
upper roots

CE

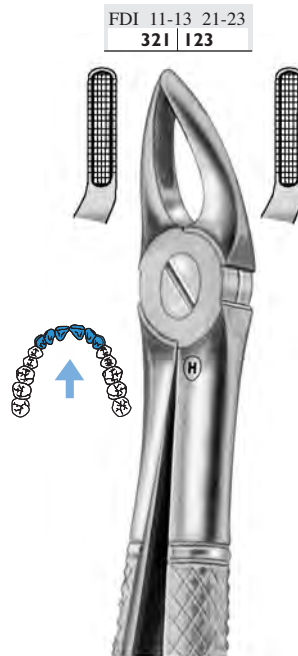

**HSA 556-30**  
fig. 30  
obere Schneidezähne u. Wurzeln, beide Seiten  
upper roots and incisors, either side

CE

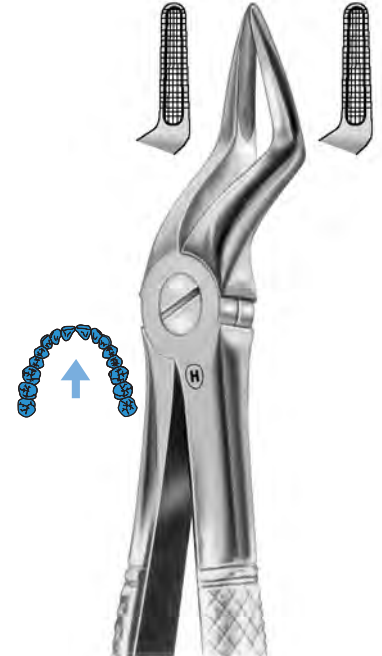

**HSA 557-51**  
fig. 51  
obere Wurzeln  
upper roots

CE



**HSA 558-51**  
fig. 51A  
obere Wurzeln mit extra schmalen Schnabel  
upper roots, very narrow beak

CE

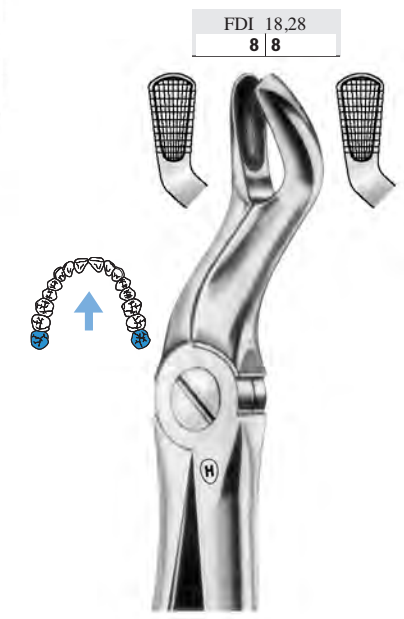

**HSA 559-67**  
fig. 67A  
obere Weisheitszähne, beide Seiten  
upper wisdoms, either side

CE

**Zahnzangen, englische Form, mit Haftprofil, mit Teflonscheibe im Schloss für ein dauerhaft leichtes und gleichmäßiges Öffnen und Schließen**  
**Extracting forceps, English pattern, with nonslip jaws, with Teflon disc in the lock for a permanent easy and smooth opening and closing**



**54 | 45**  
FDI 34,35 44,45

**HSA 572-13**  
*fig. 13*  
untere Prämolaren, beide Seiten  
lower premolars, either side

CE

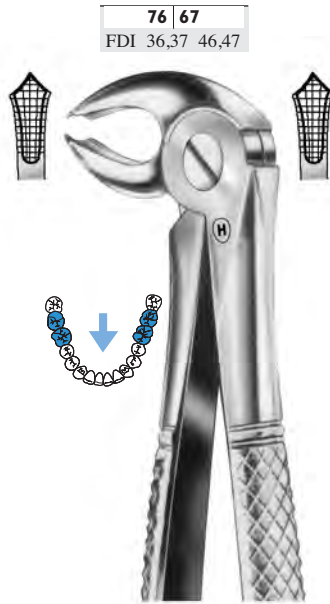

**76 | 67**  
FDI 36,37 46,47

**HSA 573-22**  
*fig. 22*  
untere Molaren, beide Seiten  
lower molars, either side

CE



**321 | 123**  
FDI 31-33 41 43

**HSA 577-74**  
*fig. 74*  
untere Schneidezähne u. Wurzeln, beide Seiten  
lower incisors and roots, either side

CE

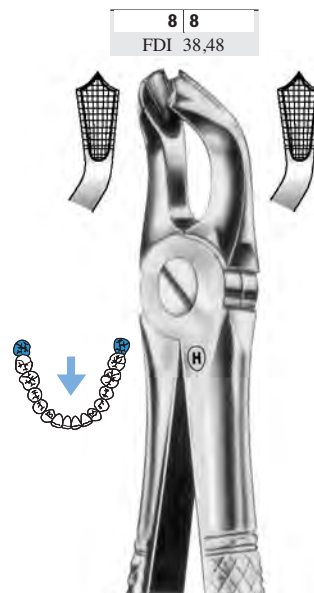

**8 | 8**  
FDI 38,48

**HSA 580-79**  
*fig. 79*  
untere Weisheitszähne, beide Seiten  
lower wisdoms, either side

CE

**TOP  
HANDY**

- ✓ kleiner und leichter
- ✓ smaller and lighter

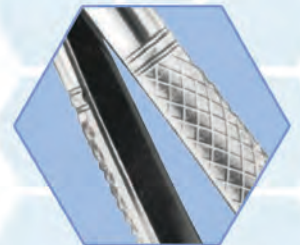

- ✓ mit Haftprofil
- ✓ with nonslip jaws

Wurzelheber • Syndesmotome • Luxationsinstrumente  
 Root elevators • Syndesmotomes • Luxation instruments



**HSA 600-01**  
*fig. 1*  
**Bein**  
 2 mm  
 obere Wurzeln  
 upper roots

CE



**HSA 601-02**  
*fig. 2*  
**Bein**  
 3 mm  
 obere Wurzeln  
 upper roots

CE



**HSA 602-03**  
*fig. 3*  
**Bein**  
 4 mm  
 obere Wurzeln  
 upper roots

CE



**HSA 605-01**  
*fig. 1*  
**Bein**  
 2 mm  
 obere Wurzeln  
 upper roots

CE



**HSA 606-02**  
*fig. 2*  
**Bein**  
 3 mm  
 obere Wurzeln  
 upper roots

CE



**HSA 607-03**  
*fig. 3*  
**Bein**  
 4 mm  
 obere Wurzeln  
 upper roots

CE



**HSA 622-02**  
*fig. 2(L)*  
**Flohr**  
 3 mm  
 untere Wurzeln  
 lower roots

CE



**HSA 623-03**  
*fig. 3(R)*  
**Flohr**  
 3 mm  
 untere Wurzeln  
 lower roots

CE

Kombination des rechten und linken gebogenen Zahn- und Wurzelhebbers in einem Instrument durch beidseitige hohlkehlförmige Aussparung an der Hebberspitze.

- Mesiale als auch distale Luxationen der Zahnwurzel mit nur einem Zahn- und Wurzelheber möglich.
- Dadurch Einsparung des rechten und linken Zahn- und Wurzelhebbers. Der ständige Wechsel der Instrumente entfällt.
- Zeitlicher Aufwand für Zahnarzt und Patienten werden erheblich verkürzt. Psychische Belastung für Patienten ist geringer.
- Es müssen weniger Instrumente sterilisiert werden.
- Abrutschgefahr beim Extraktionsvorgang ist deutlich gemindert durch grazile Gestaltung der Hebberspitze und bessere Haftung des Hebbers in der Alveole.
- Gerader Zahn- und Wurzelheber mit beidseitiger Hohlkehle für den Gebrauch im Oberkieferbereich.

### Kombinierter Zahn- und Wurzelheber nach Lindenblatt

Mit einem Wurzelheber, egal welcher Art und Form, kann ein behandelnder Zahnarzt bei unsachgemäßem Anwendung und zu starker Kräfteinwirkung immer Schäden in Form von Weichteilverletzungen und Knochenbrüchen setzen. Erfahrung und Feingefühl spielen in jedem Falle eine Rolle.

Nun zunächst zum abgewinkelten Hebel für den Unterkiefer. Der Vorteil der rechten und linken Hebelwirkung bzw. nach vorn und hinten ist sicher unbestreitbar. Betrachtet man die anatomischen Verhältnisse der Zahnwurzel, schmiegt sich die Form der herkömmlichen Wurzelheber (Bein und Flohr) höchstens bis zu den Prämolaren (erster bis fünfter Zahn von der Mitte aus gesehen) den Zahnwurzeln an. Die Kräfte beim Hebeln wirken gleichmäßig auf die der Wurzel gegenüberliegenden Knochenwand ein.

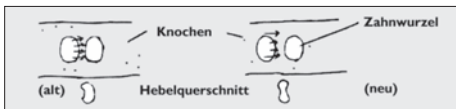

Die dünne Wand zwischen den Zähnen bzw. Wurzeln kann bei zu großer Hebelwirkung brechen. Bei dem Gebrauch des neuen Hebbers liegt die Hauptkräfteinwirkung außen an den stärkeren, dickeren Knochenanteilen. Die Knochenwand wird nur indirekt belastet und kann nach Überschreitung der Elastizitätsgrenze ebenso brechen, aber keinesfalls schneller. Hauptprobleme bei der Extraktion von Zähnen im Unterkiefer liegen aber zumeist im Molarenbereich (Zähne 6 bis 8, Mahlzähne), die zwei Wurzeln besitzen. Vergleicht man die Breite der Knochenwand mit der Hebelbreite (bitte selbst einmal in den Mund schauen), nimmt die Größe der Hebberspitze höchstens die Hälfte bis 1/3 ein. Die Form der herkömmlichen Hebel paßt sich in keinsten Weise, wie immer vermutet, der Knochenwandform an.

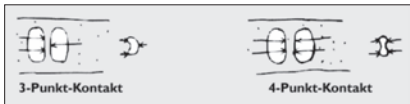

Geht man zwischen der vorderen und hinteren Wurzel mit dem Wurzelheber in das Zahnfach ein, kann die abgerundete Seite nur an einem Punkt Kontakt zur benachbarten Zahnwurzel haben, was oftmals beim Gebrauch zum Abrutschen führt, entweder in das angrenzende Zahnfleisch des Patienten oder in die Hand des Operateurs. Der modifizierte Hebel bietet mindestens vier Angriffs- und Abstützpunkte und die Abrutschgefahr ist deutlich gemindert!

Der beidseitig konkave Querschnitt der Hebberspitze bietet den Vorteil bei Serienextraktionen (Entfernung mehrerer Zähne nebeneinander):

- Gleichzeitige Lockerung des rechten und linken Zahnes und kein Abrutschen durch Angleichung an die anatomische Form.

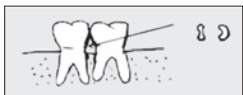

Vor der Entfernung eines Zahnes empfiehlt es sich, das Zahnfleisch vom Knochenverband zu lösen. Bei, natürlich vorausgesetzt, vorsichtiger Verwendung des Hebbers kommt es zu keinen zusätzlichen Verletzungen am Zahnfleisch (getestet!), denn durch die zweite Hohlkehle sind keine zusätzlichen scharfen Kanten gesetzt worden.

Nun zu dem geraden Hebel für den Oberkiefer:

Bei Serienextraktionen s.o. leistet er gute Dienste, und betrachtet man die Lage der oberen Zahnwurzeln, liegen schon anhand der Skizze aufgrund der anatomischen Verhältnisse die Vorteile auf der Hand, denn jeweils zwei Wurzeln können gleichzeitig luxiert werden.

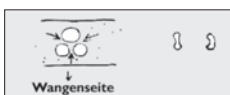

Hervorheben möchten wir auch noch die grazile Gestaltung der Hebberspitze, die ein leichteres Eindringen zwischen Knochen und Zahn ermöglicht.

Combination of the right-hand and left-hand bent tooth and root elevator in one instrument by means of a two-sided channel-shaped recess at the elevator tip.

- Both mesial and distal dislocations of the tooth root possible with only one tooth and root elevator.
- Thus saving of the right-hand and left-hand tooth and root elevators.
- Constant changing of instruments can be dispensed with.
- Time consumed by dentist and patients is considerably reduced.
- Psychological stress for the patient is reduced.
- Fewer instruments have to be sterilised.
- Danger of slipping off during the extraction process is considerably reduced by graceful design of the elevator tip and better adhesion of the elevator in the alveolus.
- Straight tooth and root elevator with channels on both sides for the use in the upper jaw area.

### Combined tooth- and root elevator acc. to Lindenblatt

With a root elevator of any kind and form an attending dentist can cause damages by an improper application and too much strength and force, namely soft part injuries and fractures of bones. Experience and sensitiveness are an object in any case.

Now at first, the bent elevator for the lower jaw. The advantages of the right and left leverage effect respectively forward and back are certainly incontestable. Considering the anatomical conditions of the root of a tooth, the form of the conventional root elevator nestles to the roots of the tooth at the best only up to the premolars (first up to fifth tooth - seen from the middle). The forces of the elevator act steadily upon the bony wall lying opposite to the root.

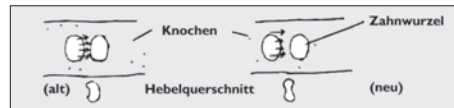

The thin wall between the teeth respectively the roots can break when the leverage effect is too strong. When using the new elevator the main influence is outside where the stronger and thicker parts of the bones are. The bony wall will be affected only indirectly and can also break when exceeding the limits of the elasticity, but by no means faster. The main problems in connection with the extraction of teeth in the lower jaw are lying in the area of the molars (teeth 6 to 8 - grinding teeth) which have 2 roots. Comparing the width of the bony wall with the width of the elevator (please look into the mouth by your own) the size of the elevator tip takes only the half or a third of it. The form of the conventional elevator does not fit in any way - as often supposed - to the form of the bony wall.

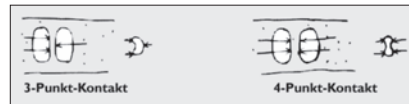

If you put the root elevator between the front and the back root in the dental alveolus, the rounded side can have contact to the neighboured root of a tooth at only one point, which is often leading to a slipping off either in the adjoining gums of the patient or in the hand of the medical attendant. The modified elevator offers at least 4 points of attack and support and the danger of slipping off is considerably reduced!

The on both sides concave cross-section of the elevator tip offers the advantage in connection with serial extractions (removal of several teeth side by side):

- Loosening of the right and left tooth at the same time and no slipping off by adjustment to the anatomical form.



Before the removal of the tooth it is recommended to loosen the gums from the teeth. When using the elevator of course carefully no additional injuries will occur to the gums (tested!) since because of the second channel no additional sharp edges exist.

Now, the straight elevator for the upper jaw:

On serial extractions as above the elevator does a good turn, and considering the situation of the upper roots of the teeth the advantages are quite obvious due to the anatomical conditions which can be seen on the sketch, since each 2 roots can be dislocated at the same time.

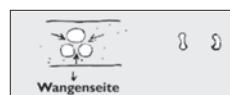

We would like to emphasise the graceful design of the elevator tip which makes a better penetration between bone and tooth possible.

Pat. Nr.:

P 198 16 242.1



**HSA 628-02**  
fig. 2/3  
**Lindenblatt**  
sterilisierbar /  
sterilizable

CE

**HSA 627-01**  
fig. 1

**Lindenblatt**  
sterilisierbar / sterilizable

CE

Kombinierter Zahn- und Wurzelheber  
Combined tooth and root elevator

Wurzelheber • Syndesmotome • Luxationsinstrumente  
 Root elevators • Syndesmotomes • Luxation instruments



**HSA 647-27**  
*fig. 27*  
**Cryer**  
 untere Wurzeln, links  
 lower roots, left

CE



**HSA 647-28**  
*fig. 28*  
**Cryer**  
 untere Wurzeln, rechts  
 lower roots, right

CE



**HSA 648-39**  
*fig. 39*  
**Cryer**  
 untere Wurzeln, links  
 lower roots, left

CE



**HSA 648-40**  
*fig. 40*  
**Cryer**  
 untere Wurzeln, rechts  
 lower roots, right

CE



**HSA 650-01**  
*fig. 1 / 301*  
**Apical**  
 obere Wurzeln  
 upper roots

CE



**HSA 651-02**  
*fig. 2 / 304*  
**Apical**  
 obere Wurzeln  
 upper roots

CE

**Wurzelheber • Syndesmotome • Luxationsinstrumente  
Root elevators • Syndesmotomes • Luxation instruments**



**HSA 605-11**  
*fig. 0*  
**Bein**  
2 mm  
CE

**HSA 606-12**  
*fig. 1*  
**Bein**  
3 mm  
CE

**HSA 607-13**  
*fig. 2*  
**Bein**  
4 mm  
CE

**HSA 675-71**  
*fig. 71*  
**Miller-Apexo**  
2 mm  
CE

**HSA 676-72**  
*fig. 72*  
**Miller-Apexo**  
2 mm  
CE

**HSA 677-73**  
*fig. 73*  
**Miller-Apexo**  
2 mm  
CE

**HSA 678-74**  
*fig. 74*  
**Miller-Apexo**  
2 mm  
CE

Zur Entfernung von gebrochenen oder tiefsitzenden Wurzelspitzen.  
For the removal of ruptured or deep-seated root apices.

Wurzelheber • Syndesmotome • Luxationsinstrumente  
Root elevators • Syndesmotomes • Luxation instruments



**HSA 700-00**  
*fig. 1*  
**Bernard**  
4 mm  
CE

**HSA 702-02**  
*fig. 2*  
**Bernard**  
4 mm  
CE

**HSA 703-03**  
*fig. 3L*  
**Bernard**  
4 mm  
CE

**HSA 704-04**  
*fig. 4R*  
**Bernard**  
4 mm  
CE

**HSA 701-01**  
**Lindo-Levin**  
3 mm  
CE

**HSA 701-02**  
**Lindo-Levin**  
3,5 mm  
CE

- ✓ schlanke und grazile Arbeitsenden
- ✓ die Spitze ermöglicht einen optimalen Zugang in den Alveolarspalt, auch interdental
- ✓ die Pfeilspitze mit leichter Vertiefung begünstigt eine gute Rotation des Hebels im Alveolarspalt
- ✓ die abgewinkelte Form ist sehr gut für den distalen Bereich geeignet
- ✓ delicate working ends
- ✓ the tip makes an optimal entrance in the alveolar cleft possible, also interdental
- ✓ the head of the arrow with a small cavity favours a good rotation of the lever in the alveolar cleft
- ✓ the bent form is very suitable for the distal area

Diese Wurzelheber haben die Vorzüge, gefahrlos die Wurzeln mit Gefühl und wenig Druck zu extrahieren. Mit einer leichten Drehbewegung wird der Lindo-Levin zwischen Alveole und Wurzel geschoben, bis sich die Fräsung an den Wurzeln festsetzt. Durch das gerade Herunterziehen entsteht die Widerhaken-Situation, die die Wurzel ohne Hebelwirkung extrahiert. Es sollte nicht gehiebelt werden, da die Fräsung Bruchgefahr in sich birgt.

These root elevators have the advantage that, with cautiousness and little pressure extracting the roots without risk. With a slight rotary movement the Lindo-Levin is pushed between alveolus and root until the groove becomes lodged in the roots. As a result of the straight pulling-down the barb situation arises in which the root is extracted without leverage. No levering should be done as the groove entails the danger of rupture.

Alle mit CE gekennzeichneten Produkte sind Medizinprodukte. | All products marked with CE are medical devices.



**Wurzelheber • Syndesmotome • Luxationsinstrumente  
Root elevators • Syndesmotomes • Luxation instruments**



**HSA 705-01**  
3,0 mm  
sterilisierbar , gerade  
sterilizable , straight  
**CE**

**HSA 705-02**  
3,0 mm  
sterilisierbar , gebogen  
sterilizable , curved  
**CE**

**HSA 705-03**  
5,0 mm  
sterilisierbar , gerade  
sterilizable , straight  
**CE**

**HSA 705-04**  
5,0 mm  
sterilisierbar , gebogen  
sterilizable , curved  
**CE**

**Luxationsinstrumente**

- ☑ haben ein sehr flaches und scharfkantiges Arbeitsende
- ☑ durch eine leicht rotierende und zugleich schneidende Drehbewegung werden die zahnfixierenden Ligamente sauber durchtrennt und die Alveole schonend erweitert

**Instruments for luxation**

- ☑ have an extremely flat and sharp-edged working tip
- ☑ by the slight rotating as well as cutting movement the tooth-fixed ligaments will be cut precisely and the alveolus will be carefully enlarged



**Solingen**

Wurzelheber • Syndesmotome • Luxationsinstrumente  
Root elevators • Syndesmotomes • Luxation instruments*bobl  
bollow**bobl  
bollow**bobl  
bollow**bobl  
bollow***HSA 706-01**  
sterilisierbar / sterilizable3mm, gerade  
3mm, straight

CE

**HSA 706-02**  
sterilisierbar / sterilizable3mm, gebogen  
3mm, curved

CE

**HSA 707-01**  
sterilisierbar / sterilizable5mm, gerade  
5mm, straight

CE

**HSA 707-02**  
sterilisierbar / sterilizable5mm, gebogen  
5mm, curved

CE

**HSA 708-01**  
4mm  
sterilisierbar / sterilizableWurzelheber; **hohl**  
Root lifter; **hollow**

CE

**HSA 708-02**  
4mm  
sterilisierbar / sterilizableWurzelheber; **hohl**  
Root lifter; **hollow**

CE

**Luxationsinstrumente**

- ✓ haben ein sehr flaches und scharfkantiges Arbeitsende
- ✓ durch eine leicht rotierende und zugleich schneidende Drehbewegung werden die zahnfixierenden Ligamente sauber durchtrennt und die Alveole schonend erweitert

**Instruments for luxation**

- ✓ have an extremely flat and sharp-edged working tip
- ✓ by the slight rotating as well as cutting movement the tooth-fixed ligaments will be cut precisely and the alveolus will be carefully enlarged

Wurzelheber • Syndesmotome • Luxationsinstrumente  
Root elevators • Syndesmotomes • Luxation instruments



**HSA 726-01**  
*fig. 1*  
**Heidbrink**  
obere Wurzeln  
upper roots

CE



**HSA 727-02**  
*fig. 2(L)*  
**Heidbrink**  
untere Wurzeln  
lower roots

CE



**HSA 728-03**  
*fig. 3(R)*  
**Heidbrink**  
untere Wurzeln  
lower roots

CE



**HSA 735-01**  
*fig. 1*  
**Heidbrink**  
1,2 mm

CE



**HSA 736-02**  
*fig. 2*  
**Heidbrink**  
1,5 mm

CE



**HSA 737-03**  
*fig. 3*  
**Heidbrink**  
1,8 mm

CE

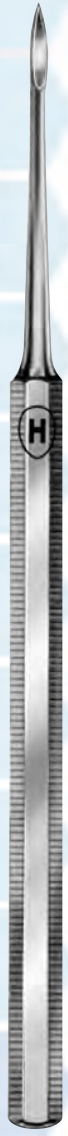
**Wurzelheber • Syndesmotome • Luxationsinstrumente**  
**Root elevators • Syndesmotomes • Luxation instruments**

**HSA 731-01**  
*fig. 1*  
**Heidbrink**  
 obere Wurzeln  
 upper roots

CE



**HSA 732-02**  
*fig. 2(L)*  
**Heidbrink**  
 untere Wurzeln  
 lower roots

CE

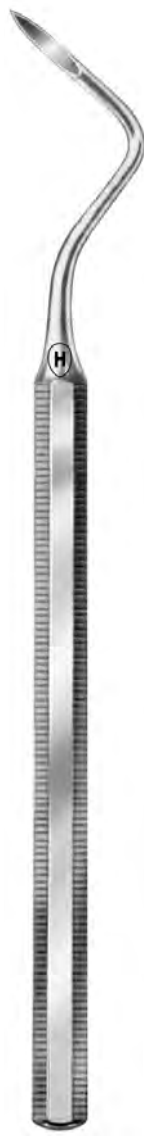

**HSA 733-03**  
*fig. 3(R)*  
**Heidbrink**  
 untere Wurzeln  
 lower roots

CE



**HSA 750-01**  
*fig. 1*  
**Coupland**  
 3 mm

CE



**HSA 751-02**  
*fig. 2*  
**Coupland**  
 3,5 mm

CE



**HSA 752-03**  
*fig. 3*  
**Coupland**  
 4 mm

CE

**HSA 7500-01**  
*fig. 1*  
**Coupland**  
 3 mm

 mit Haarzahnung  
 with micro tothing

CE

**HSA 7510-02**  
*fig. 2*  
**Coupland**  
 3,5 mm

 mit Haarzahnung  
 with micro tothing

CE

**HSA 7520-03**  
*fig. 3*  
**Coupland**  
 4 mm

 mit Haarzahnung  
 with micro tothing

CE



**HSA 755-01**  
*fig. 1*  
**Warwick-James**

CE



**HSA 756-02**  
*fig. 2*  
**Warwick-James**

CE



**HSA 757-03**  
*fig. 3*  
**Warwick-James**

CE

Wurzelheber • Syndesmotome • Luxationsinstrumente  
Root elevators • Syndesmotomes • Luxation instruments

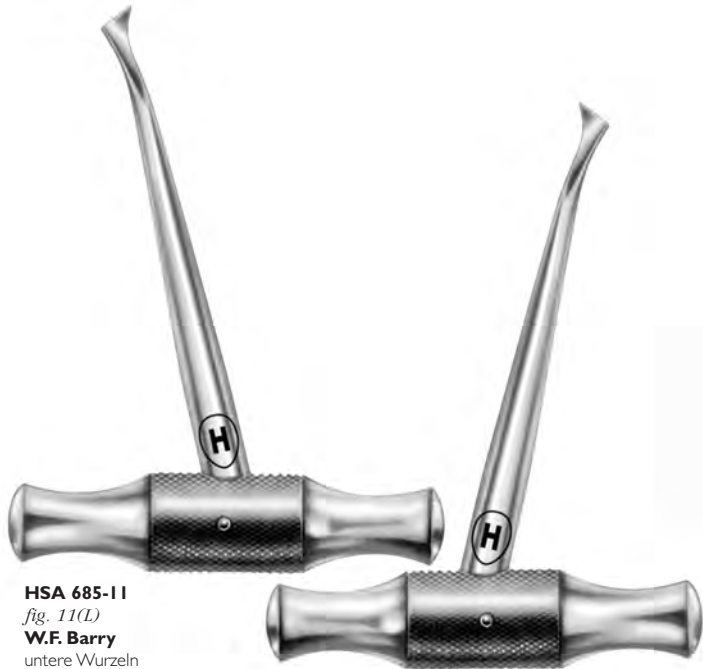

**HSA 685-11**  
fig. 11(L)  
**W.F. Barry**  
untere Wurzeln  
lower roots

CE



**HSA 686-12**  
fig. 12(R)  
**W.F. Barry**  
untere Wurzeln  
lower roots

CE

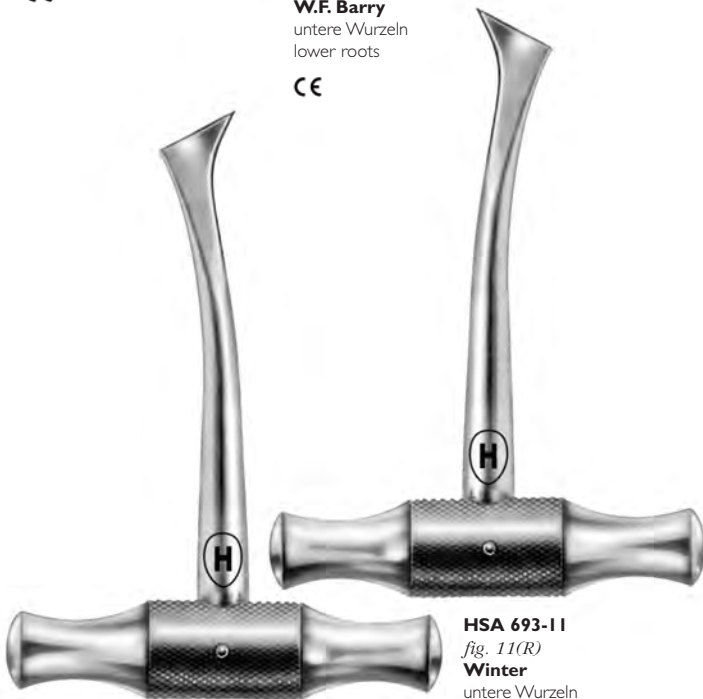

**HSA 692-11**  
fig. 11(L)  
**Winter**  
untere Wurzeln  
lower roots

CE

**HSA 693-11**  
fig. 11(R)  
**Winter**  
untere Wurzeln  
lower roots

CE



**HSA 710-28**  
2,8 mm  
**ZA M. Beck**  
CE

**HSA 710-35**  
3,5 mm  
**ZA M. Beck**  
CE

**Hypomochlion:**

Drehpunkt, Abstützungspunkt eines Hebels  
Fulcrum, point of support of an elevator

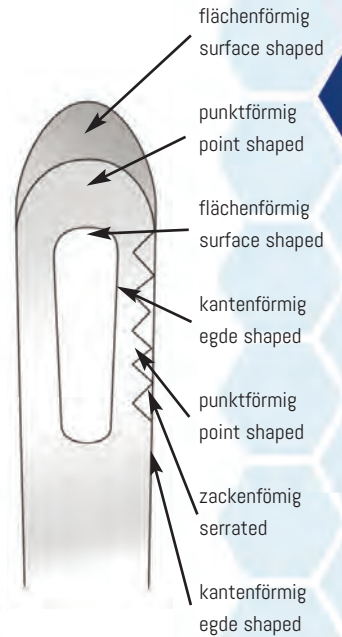

Durch den Parabelschliff am Instrumentenende und der konkavförmigen Fläche ist ein schonendes Eindringen in den Interdentalraum bzw. Periodontalspalt optimal gewährleistet.

Aufgrund dieser Formgebung sind durch 180° Drehung 4 Luxationsbewegungen möglich, je 2 x mesial und 2 x distal. Der Hebel arbeitet während des Luxationsvorganges mit 6 – 7 Hypomochlien, dadurch ist er jedem herkömmlichen Hebel deutlich überlegen (maximal 1 – 2 Hypomochlien).

By the parabola cross section at the end of the instrument and the concave shaped surface a careful penetration in the interdental space respectively periodontal interstice is optimally ensured. Due to this shaping 4 luxator movements are possible by a 180° turn, 2 x mesial and 2 x distal. The elevator works during the luxator procedure with 6 – 7 "Hypomochlion", therefore it is clearly superior to each conventional elevator (maximum 1 – 2 "Hypomochlion").

**Modifizierte Hebel nach Schemmel**

Der modifizierte Hebel nach Schemmel vereint die Vorteile eines Hebels mit denen eines Wurzelspitzenhebers. Der entscheidende Vorteil ist die V-förmige Einkerbung in der Mitte des Hebels mit den außenliegenden scharfen Spitzen am Arbeitsende. Das Instrument wird parallel zur Längsachse des zu entfernenden Zahnes oder Wurzelrestes zwischen Knochen und Zahnwurzel zirkulär rotierend eingeführt. Dabei wird das Arbeitsende mit dem Pinzettengriff der freien Hand am Zahn fixiert, so dass die Spitzen des Arbeitsendes an der Wurzel entlanggleiten. Wichtig bei der Luxationsbewegung ist die ausreichende Abstützung des alveolären Bereichs durch den Behandler. Durch die Zweipunktführung der Spitzen an der Wurzel wird das Abrutschen in den Knochen, im Vergleich zu den herkömmlichen Hebeln mit abgerundetem Arbeitsenden erschwert. Dadurch wird der zu extrahierende Zahn oder Wurzelrest wesentlich aktiver und sicherer luxiert, so dass eine operative Entfernung (sog. Aufklappung) vermieden werden kann. Die Form der Luxationsbewegung ist bei jedem Zahn sehr individuell und ist insbesondere von der anatomischen Wurzelform abhängig. Eine Orientierung am präoperativen Röntgenbild kann als Hinweis auf die günstigste Luxationsrichtung dienen. Dennoch bestehen immer wieder individuelle Unterschiede, daher ist vor allem das Gefühl des Behandlers gefragt, die jeweils leichteste Luxationsrichtung zu erspüren. Nur so lassen sich Gewebeschäden und Drucknekrosen des alveolären Knochens reduzieren.

**Vorteile:**

- ✓ geringeres Risiko für Nachbarzähne und Zahnersatz, da eine Abstützung nicht notwendig ist
- ✓ geringeres Risiko einer perforierenden Weichteilverletzung durch Abgleiten des Instruments
- ✓ Vermeidung einer operativen Entfernung (Aufklappung)
- ✓ geringeres Trauma
- ✓ geringere Nebenwirkungen
- ✓ Zeitersparnis

**Modified lever according to Schemmel**

The modified lever according to Schemmel combines the advantages of a lever with those of a root tip elevator. The key advantage is the V-shaped indentation in the center of the lever with the outward-facing sharp tips at the working end. The instrument is inserted in a circular rotating manner parallel to the longitudinal axis of the tooth or root rest to be removed between the bone and the tooth root. In doing so, the working end is fixed to the tooth with the tweezer handle of the free hand so that the tips of the working end slide along the root. Important for the luxation movement is the sufficient support of the alveolar area by the practitioner. The two-point guidance of the tips at the root makes the slipping into the bone, compared to the conventional levers with a rounded working end, more difficult. As a result, the tooth or root residue to be extracted is significantly more actively and safely luxated so that an operative removal (so-called fold-open) can be avoided.

The form of the luxation movement is very individual in each tooth and depends in particular on the anatomical root shape. An orientation to the preoperative X-ray image can serve as a reference to the most favorable dislocation direction. Nevertheless, there are always individual differences, so the feeling of the practitioner is in particular required to find the easiest direction of dislocation. Only in this way tissue damage and pressure necrosis of the alveolar bone can be reduced.

**Advantages:**

- ✓ less risk for adjacent teeth and dental prosthesis, since support is not necessary
- ✓ less risk of perforating soft tissue injury by sliding down the instrument
- ✓ avoidance of an operative removal (so-called fold-open)
- ✓ less severe trauma
- ✓ minor side effects
- ✓ time savings



**HSA 7060-03  
Dr. Schemmel**  
3 mm

**CE**  
**Luxationsinstrument,**  
gebogen, 3 mm, mit Rille,  
nach Dr. Schemmel  
**Luxation instrument,**  
curved, 3 mm, with groove,  
acc. to Dr. Schemmel

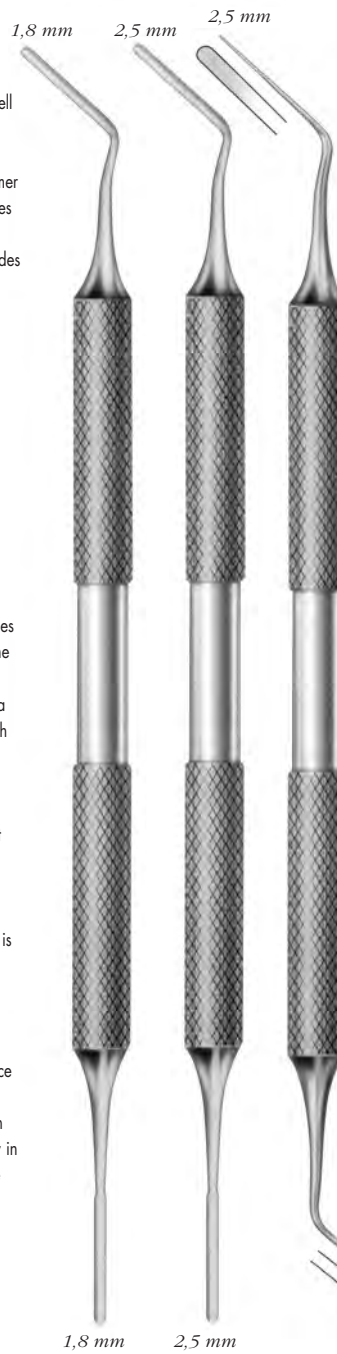

**HSK 380-01** 170 mm **HSK 381-02** 170 mm **HSK 382-03** 170 mm  
**Periotom** **Periotom** **Periotom**  
**Periotome** **Periotome** **Periotome**  
**CE** **CE** **CE**



**HSK 3810-01** **HSK 3830-03**  
*Fig. 1* *Fig. 3*  
**CE** **CE**  
**HSK 3820-02** **HSK 3840-04**  
*Fig. 2* *Fig. 4*  
**CE** **CE**  
**Flexi Periotom**  
**Flexi Periotome**

Spritzen  
Syringes

Zylinderampullenspritze mit Aspiration (CW Typ)  
Cartridge syringes with aspiration (CW Type)

- ↙ seitliche Beladung
  - ↙ metrisches Gewinde
  - ↙ für alle handelsüblichen Zylinderampullen
  - ↙ Handstück und Ziehring frei drehbar
  - ↙ Vorderteil nicht abnehmbar
  - ↙ zuverlässige Aspiration mit Pfeilspitze
  - ↙ sichere Handhabung und leichte Reinigung
  - ↙ autoklavierbar bei 134°C / 273°F
- ↙ side loading
  - ↙ metric thread
  - ↙ for all standard cartridges
  - ↙ hand piece and pull ring can rotate freely
  - ↙ the front part cannot be removed
  - ↙ reliable aspiration with arrow head
  - ↙ safe handling and easy cleaning
  - ↙ autoclavable at 134°C / 273°F



HSA 842-18  
= 1,8 ml

CE

HSA 843-22  
= 2,2 ml

Zylinderampullen-Spritzen mit Aspiration  
cartridge syringe, with aspiration

CE



HSA 836-18  
1,8 ml

Zylinderampullenspritze mit Aspiration (CW Typ)  
Cartridge syringes with aspiration (CW Type)

CE



HSA 829-00  
1,8 ml

Intraligamentäre Spritze  
Intraligamentary syringe

CE

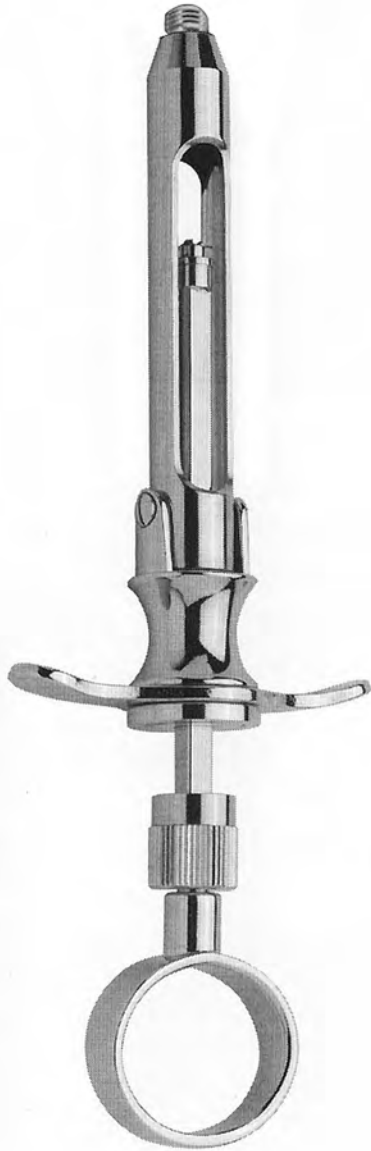
Spritzen  
Syringes

**HSA 830-18**  
1,8 ml  
mit 3 Aspirationshäkchen und Selbstaspiration  
with 3 aspiration hooks and self-aspiration

**Dental-Zylinderampullenspritze mit Klappmechanik**  
Dental cartridge syringe with hinged retainer  
CE



**HSA 831-18**  
1,8 ml  
mit Pfeilspitze  
with arrow tip  
CE

Für Zylinderampullen 1,8 ml, mit aufgeschraubtem Ansatzstück und Daumenring  
For cylindric cartridges 1,8 ml, with screw-on attachment and thumb ring



Wangenhalter  
Cheek retractors

Wangenhalter / Cheek retractor

- ✓ besonders gut geeignet für intraorale Fotoaufnahmen
- ✓ particularly well suitable for intraoral photographs

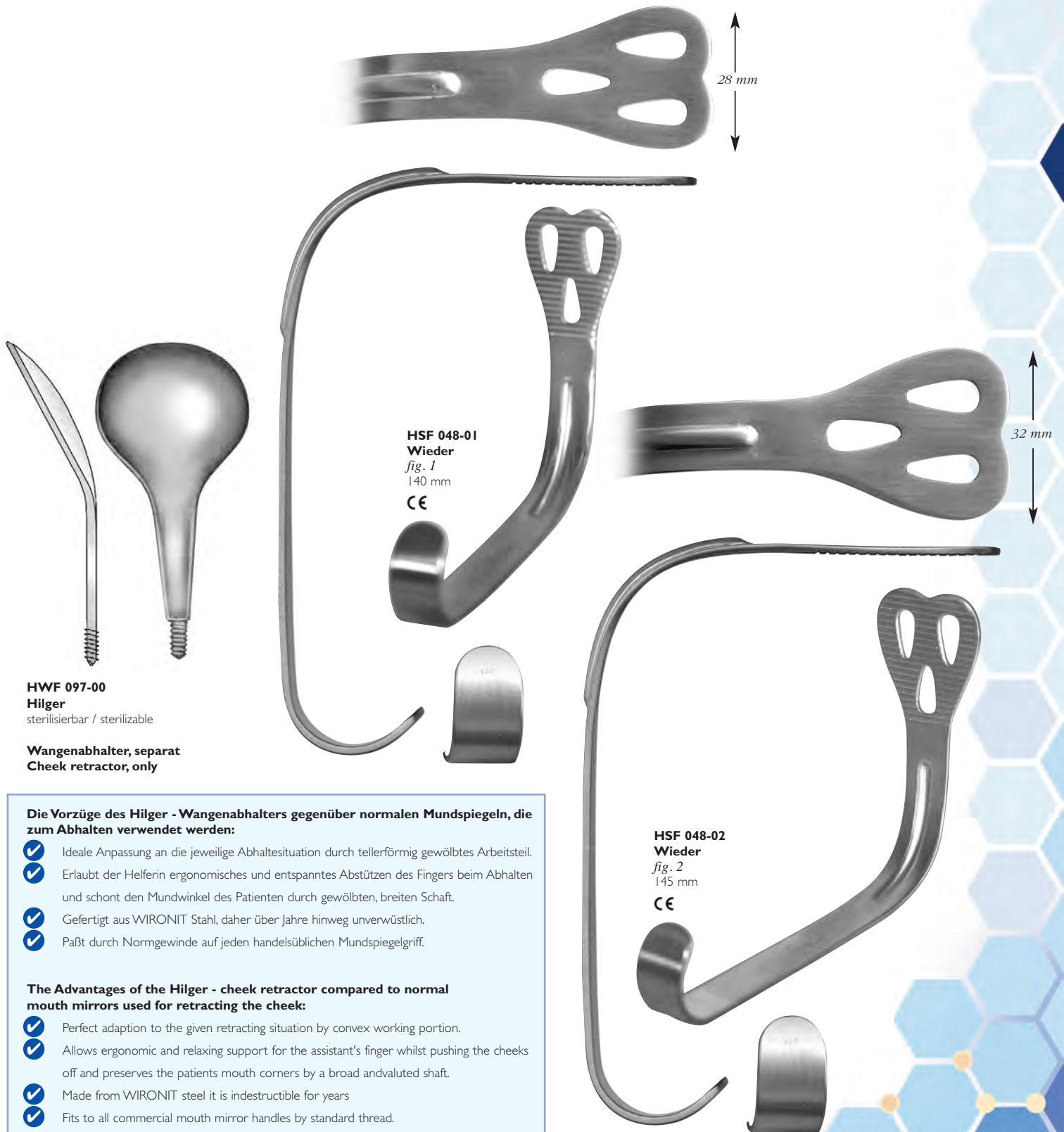

**HWF 097-00**  
Hilger  
sterilisierbar / sterilizable

Wangenabhalter, separat  
Cheek retractor, only

**HSF 048-01**  
Wieder  
fig. 1  
140 mm  
CE

**HSF 048-02**  
Wieder  
fig. 2  
145 mm  
CE

**Die Vorzüge des Hilger -Wangenabhalters gegenüber normalen Mundspiegeln, die zum Abhalten verwendet werden:**

- ✓ Ideale Anpassung an die jeweilige Abhaltesituation durch tellerförmig gewölbtes Arbeitsteil.
- ✓ Erlaubt der HelferIn ergonomisches und entspanntes Abstützen des Fingers beim Abhalten und schont den Mundwinkel des Patienten durch gewölbten, breiten Schaft.
- ✓ Gefertigt aus WIRONIT Stahl, daher über Jahre hinweg unverwüstlich.
- ✓ Paßt durch Normgewinde auf jeden handelsüblichen Mundspiegelgriff.

**The Advantages of the Hilger - cheek retractor compared to normal mouth mirrors used for retracting the cheek:**

- ✓ Perfect adaption to the given retracting situation by convex working portion.
- ✓ Allows ergonomic and relaxing support for the assistant's finger whilst pushing the cheeks off and preserves the patients mouth corners by a broad andvaluted shaft.
- ✓ Made from WIRONIT steel it is indestructible for years
- ✓ Fits to all commercial mouth mirror handles by standard thread.

Alle mit CE gekennzeichneten Produkte sind Medizinprodukte. | All products marked with CE are medical devices.

Wangenhalter  
Cheek retractorsWangenhalter nach Prof. Dr. Günay  
Cheek retractor acc. to Prof. Dr. Günay

- ✓ besonders gut geeignet für intraorale Fotoaufnahmen
- ✓ particularly well suitable for intraoral photographs



**HWF 033-01**  
nach Prof. Dr. Günay  
fig. 1  
90 x 40 x 40 mm

- für Kinder (1 – 7 Jahre)
- for children (1 – 7 years)

CE

**HWF 033-11**  
nach Prof. Dr. Günay  
fig. 1  
90 x 40 x 40 mm

Set bestehend aus 2  
Wangenhaltern HWF 033-01  
Set consisting of 2 cheek  
retractors HWF 033-01

CE

**HWF 034-02**  
nach Prof. Dr. Günay  
fig. 2  
105 x 50 x 45 mm

- für Jugendliche (8 – 14 Jahre)
- for adolescent (8 – 14 years)

CE

**HWF 034-12**  
nach Prof. Dr. Günay  
fig. 2  
105 x 50 x 45 mm

Set bestehend aus 2 Wangenhaltern HWF 034-02  
Set consisting of 2 cheek retractors HWF 034-02

CE

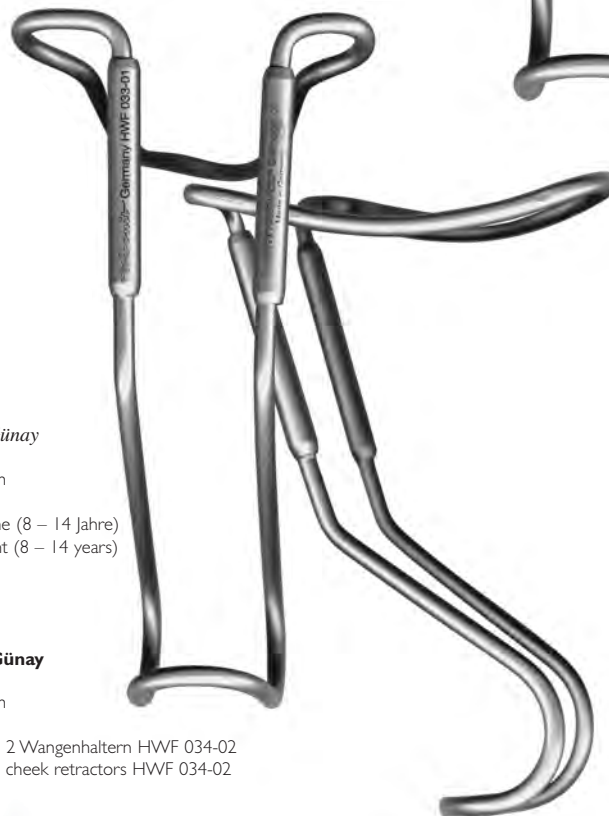

**HWF 035-03**  
nach Prof. Dr. Günay  
fig. 3  
120 x 55 x 65 mm

- für Erwachsene
- for adults

CE

**HWF 035-13**  
nach Prof. Dr. Günay  
fig. 3  
120 x 55 x 65 mm

Set bestehend aus 2 Wangenhaltern HWF 035-03  
Set consisting of 2 cheek retractors HWF 035-03

CE

Chirurgische Scheren  
Operating scissors



*spitz - spitz  
sharp - sharp*

**HSB 010-10**  
105 mm  
gerade  
straight  
CE



*spitz - spitz  
sharp - sharp*

**HSB 011-10**  
105 mm  
gebogen  
curved  
CE



*spitz - spitz  
sharp - sharp*

**HSB 014-11**  
115 mm  
gerade  
straight  
CE



*spitz - spitz  
sharp - sharp*

**HSB 015-11**  
115 mm  
gebogen  
curved  
CE



*spitz - spitz  
sharp - sharp*

**HSB 028-15**  
**Joseph**  
140 mm  
gerade  
straight  
CE



*spitz - spitz  
sharp - sharp*

**HSB 029-15**  
**Joseph**  
140 mm  
gebogen  
curved  
CE



*spitz - spitz  
sharp - sharp*

**HSB 030-16**  
**Kelly**  
160 mm  
gerade  
straight  
CE

Alle mit CE gekennzeichneten Produkte sind Medizinprodukte. | All products marked with CE are medical devices.

Chirurgische Scheren  
Operating scissors

*spitz - spitz  
sharp - sharp*

**HSB 031-16**  
**Kelly**  
160 mm  
gebogen  
curved  
CE



*spitz - spitz  
sharp - sharp*

**HSB 039-16**  
**Locklin**  
160 mm  
gezahnt  
sawedged  
CE



**HSB 041-17**  
**Dean**  
170 mm  
Zahnfleischschere gezahnt, gebogen  
Gum scissors sawedged, curved  
CE

Solingen



*spitz - rund  
sharp - round*

**HSB 046-11**  
115 mm  
Coronar-Schere, gerade  
Coronary scissors, straight  
CE



*spitz - spitz  
sharp - sharp*

**HSB 047-11**  
**La Grange**  
115 mm  
gebogen  
curved  
CE



**HSB 048-13**  
**Goldman-Fox**  
130 mm  
Gingivektomie-Schere gezahnt, gerade  
Gingivectomy scissors sawedged, straight  
CE



**HSB 049-13**  
**Goldman-Fox**  
130 mm  
Gingivektomie-Schere gezahnt, gebogen  
Gingivectomy scissors sawedged, curved  
CE

Alle mit CE gekennzeichneten Produkte sind Medizinprodukte. | All products marked with CE are medical devices.

**ARQUATUS** line

Chirurgische Scheren  
Operating scissors



*spitz - spitz  
sharp - sharp*

**HSB 036-10**  
105 mm  
Zahnfleischschere, gerade  
Gum Scissors, straight  
CE



*spitz - spitz  
sharp - sharp*

**HSB 019-11**  
115 mm  
abgewinkelt  
angled  
CE



*spitz - spitz  
sharp - sharp*

**HSB 020-11**  
115 mm  
gerade, sehr fein  
straight, very delicate  
CE

Solingen

**SCHEREN  
SCISSORS**



*spitz - spitz  
sharp - sharp*

**HSB 021-11**  
115 mm  
gebogen, sehr fein  
curved, very delicate  
CE

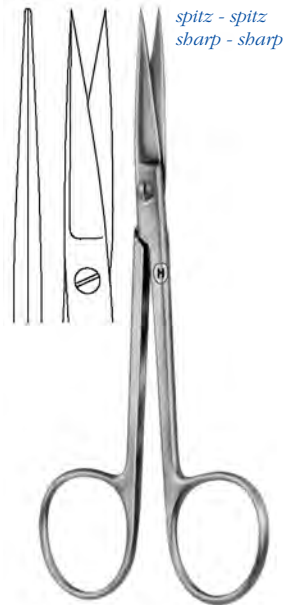

*spitz - spitz  
sharp - sharp*

**HSB 022-12  
Wagner**  
120 mm  
gerade  
straight  
CE



*spitz - spitz  
sharp - sharp*

**HSB 023-12  
Wagner**  
120 mm  
gebogen  
curved  
CE

Chirurgische Scheren  
Operating scissors

**HSB 070-11**  
Standard  
115 mm

**HSB 072-13**  
Standard  
130 mm

**HSB 074-14**  
Standard  
145 mm

**HSB 076-15**  
Standard  
155 mm

**HSB 078-16**  
Standard  
165 mm

**HSB 080-18**  
Standard  
185 mm  
gerade  
straight

CE

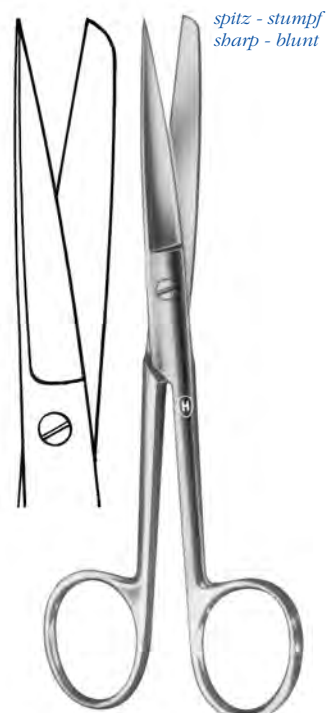

**HSB 084-11**  
Standard  
115 mm

**HSB 086-13**  
Standard  
130 mm

**HSB 088-14**  
Standard  
145 mm

**HSB 090-15**  
Standard  
155 mm

**HSB 092-16**  
Standard  
165 mm

**HSB 094-18**  
Standard  
185 mm  
gerade  
straight

CE

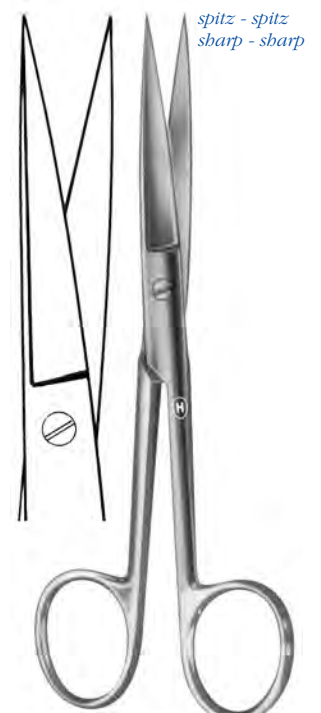

**HSB 098-11**  
Standard  
115 mm

**HSB 100-13**  
Standard  
130 mm

**HSB 102-14**  
Standard  
145 mm

**HSB 104-15**  
Standard  
155 mm

**HSB 106-16**  
Standard  
165 mm

**HSB 108-18**  
Standard  
185 mm  
gerade  
straight

CE

Solingen

Chirurgische Scheren  
Operating scissors

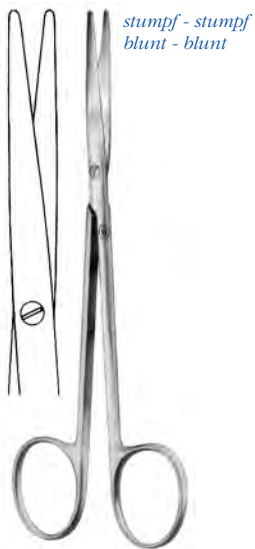

*stumpf - stumpf  
blunt - blunt*

**HSB 120-14**  
**Baby Metzenbaum**  
145 mm  
Präparierscheren, gerade  
Dissecting scissors, straight  
CE

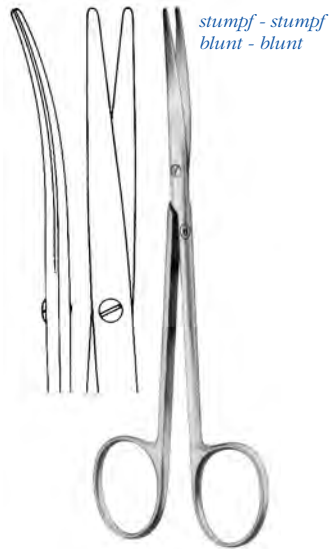

*stumpf - stumpf  
blunt - blunt*

**HSB 121-14**  
**Baby Metzenbaum**  
145 mm  
Präparierscheren, gebogen  
Dissecting scissors, curved  
CE

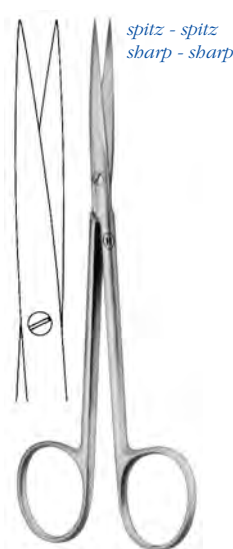

*spitz - spitz  
sharp - sharp*

**HSB 126-14**  
**Metzenbaum fino**  
145 mm  
**HSB 128-18**  
**Metzenbaum fino**  
180 mm  
Besonders feine Präparier- und Nahtscheren, gerade  
Very delicate scissors for dissecting and suture, straight  
CE

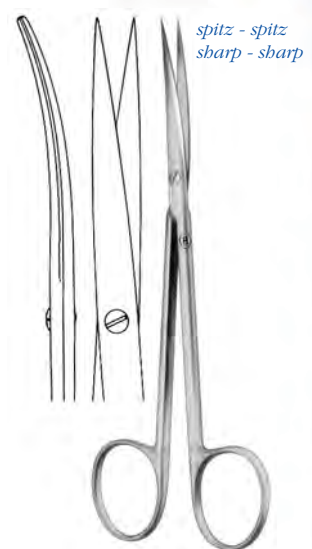

*spitz - spitz  
sharp - sharp*

**HSB 127-14**  
**Metzenbaum fino**  
145 mm  
Besonders feine Präparier- und Nahtscheren, gebogen  
Very delicate scissors for dissecting and suture, curved  
CE

Scheren mit Hartmetalleinlagen  
Scissors with tungsten carbide inserts



*spitz - spitz  
sharp - sharp*

**HSB 300-11**  
115 mm  
Zahnfleischscheren, gerade  
Gum scissors, straight  
CE



*spitz - spitz  
sharp - sharp*

**HSB 301-11**  
115 mm  
Zahnfleischscheren, gebogen  
Gum scissors, curved  
CE



*spitz - stumpf  
sharp - blunt*

**HSB 310-14**  
**Standard**  
145 mm  
Chirurgische Scheren  
Operating scissors  
CE



*spitz - spitz  
sharp - sharp*

**HSB 314-14**  
**Standard**  
145 mm  
Chirurgische Scheren, gerade  
Operating scissors, straight  
CE

OP-Spezial-Scheren  
Scissors OP-special

## SUPER-CUT

Hammachers  
OP-Spezial-Scheren

- ✓ Mikroschliff
- ✓ Die Extrascharfe für jeden Bereich in Klinik und Praxis.

Hammacher's  
OP-special scissors

- ✓ Micro section
- ✓ Extra sharp for all surgical uses in the hospital and the private practice



*spitz - spitz  
sharp - sharp*

**HSB 390-10**  
105 mm  
Zahnfleissscheren, gerade  
Gum scissors, straight

CE



*spitz - spitz  
sharp - sharp*

**HSB 391-10**  
105 mm  
Zahnfleissscheren, gebogen  
Gum scissors, curved

CE



*spitz - spitz  
sharp - sharp*

**HSB 392-11  
La Grange**  
115 mm  
S-förmig gebogen  
curved like a S

CE



*spitz - spitz  
sharp - sharp*

**HSB 394-13  
Goldman-Fox**  
130 mm  
Gingivektomie-Schere, gezahnt, S-förmig gebogen  
Gingivectomy scissors, saw edge, curved like a S

CE



*spitz - stumpf  
sharp - blunt*

**HSB 396-13  
Standard Grazil**  
130 mm  
Feine Chirurgische Scheren, gerade  
Delicate operating scissors, straight

CE



*spitz - spitz  
sharp - sharp*

**HSB 0140-11**  
115 mm  
gerade, große Griffringe  
straight, big grip rings

CE



*spitz - spitz  
sharp - sharp*

**HSB 0141-11**  
115 mm  
gebogen, große Griffringe  
curved, big grip rings

CE



OP-Spezial-Scheren  
Scissors OP-special

**SUPER-CUT**

**Hammachers  
OP-Spezial-Scheren**

- ✓✓ Mikroschliff
- ✓ Die Extrascharfe für jeden Bereich in Klinik und Praxis.

**Hammacher's  
OP-special scissors**

- ✓✓ Micro section
- ✓ Extra sharp for all surgical uses in the hospital and the private practice



Alle mit CE gekennzeichneten Produkte sind Medizinprodukte. | All products marked with CE are medical devices.



**HSB 300-00**  
**Kling-EX**

Skalpellklingen-Abnehmer  
Scalpel-blade remover

CE



**HSB 805-03**  
**Standard**  
125 mm  
No. 3

CE

Skalpellgriffe, für Klingen HSB 815-10 bis HSB 819-15  
Scalpel handles, for blades HSB 815-10 to HSB 819-15

**HSB 808-16**  
160 mm

CE

**HSB 809-16**  
160 mm

CE



**HSB 815-10**  
*fig. 10*  
steril  
sterile



**HSB 816-11**  
*fig. 11*  
steril  
sterile



**HSB 817-12**  
*fig. 12*  
steril  
sterile

CE



**HSB 818-15**  
*fig. 15*  
steril  
sterile

CE



**HSB 819-15**  
*fig. 15c*  
steril  
sterile

CE

Skalpellklingen, in Packungen zu 100 Stück, für Griffe HSB 805-03 bis HSB 809-16  
Scalpel blades, in packages of 100 pieces, for handles HSB 805-03 to HSB 809-16



**HSB 803-03**

CE

**Sicherheits-Skalpellgriff**  
**Safety scalpel handle**

Dieser Skalpellgriff reduziert das Verletzungsrisiko beim Einsetzen und Entfernen der Klinge auf ein Minimum. Er ist daher besonders für weniger routinierte Anwender zu empfehlen.

- ✓ Die Klinge muss nicht mehr im Bereich der Schneide/Spitze gefasst werden.
- ✓ Ein weiterer Vorteil ist die konstruktionsbedingte höhere Stabilität für die Klinge bei seitlicher Belastung gegenüber einem herkömmlichen Skalpellgriff.

This scalpel handle reduces the risk of injury when inserting and removing the blade to a minimum. It is therefore particularly recommended for less experienced users.

- ✓ The blade no longer has to be held in the area of cutting edge / tip.
- ✓ Another advantage is the design-related higher stability for the blade with lateral pressure compared to a conventional scalpel handle.



1 Die Klinge wird im breiten Teil über den unteren Stift gesetzt.  
The blade is set in the wide part on the lower pin.



2 Anschließend wird die Klinge bis zum Anschlag nach unten gezogen.  
Then the blade is pulled down to the stop.



3 Die Klinge wird in der Anschlag-Position um 90 Grad geschwenkt ...  
The blade is rotated in the stop position to 90 degrees ...



4 ... und zuletzt über den hinteren Stift gehoben.  
... and finally lifted over the back pin.

Skalpel und Skalpellklingen  
Scalpel and scalpel blades



**HSB 820-04**  
135 mm  
No. 4  
CE

Skalpellgriff, für Klingen HSB 826-18 bis HSB 833-25  
Scalpel handle, for blades HSB 826-18 to HSB 833-25



**HSB 826-18** **HSB 827-19** **HSB 828-20** **HSB 829-21**  
*fig. 18* *fig. 19* *fig. 20* *fig. 21*  
steril steril steril steril  
sterile sterile sterile sterile  
CE CE CE CE



**HSB 830-22** **HSB 831-23** **HSB 832-24** **HSB 833-25**  
*fig. 22* *fig. 23* *fig. 24* *fig. 25*  
steril steril steril steril  
sterile sterile sterile sterile  
CE CE CE CE

Skalpellklingen in Packungen zu 100 Stück, für Griffe HSB 820-04  
Scalpel blades in packages of 100 pcs, for handle HSB 820-04



**HSB 896-10** **HSB 897-11** **HSB 898-12** **HSB 899-15**  
*fig. 10* *fig. 11* *fig. 12* *fig. 15*  
steril steril steril steril  
sterile sterile sterile sterile  
CE CE CE CE

Einmalsskalpelle mit Kunststoffgriff in Packungen zu 10 Stück  
Disposable scalpels with plastic handle in packages of 10 pieces

## Gingivektomiemesser | Arterien- und Gefäßklemmen Gingivectomy knives | Artery and clamp forceps

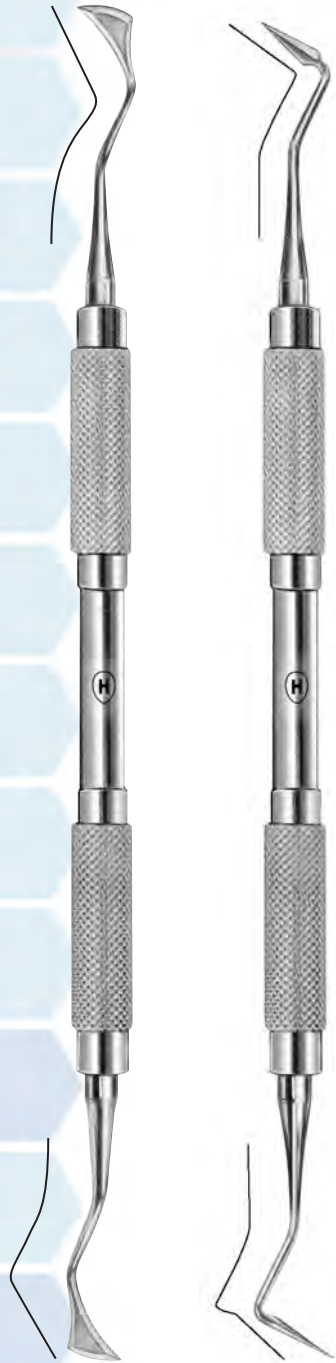

**HSG 262-00**  
fig. 15/16  
**Kirkland**  
CE

Gingivektomiemesser  
Gingivectomy knives

**HSG 268-00**  
fig. 1/2  
**Orban**  
CE



**HSE 010-09**  
**Micro-Hartmann**  
90 mm

CE

Mikro-Klemme, sehr fein, gerade  
Micro forceps, very delicate, straight



**HSE 011-09**  
**Micro-Hartmann**  
90 mm

CE

Mikro-Klemme, sehr fein, gebogen  
Micro forceps, very delicate, curved



**HSE 016-12**  
**Micro-Halsted**  
125 mm

CE

Mikro-Klemme, sehr fein, gerade  
Micro forceps, very delicate, straight



**HSE 017-12**  
**Micro-Halsted**  
125 mm

CE

Mikro-Klemme, sehr fein, gebogen  
Micro forceps, very delicate, curved



**HSE 022-12**  
**Halstead-Mosquito**  
120 mm

CE

**HSE 024-14**  
**Halstead-Mosquito**  
140 mm

CE

Schlauchklemmen bzw. Arterienklemmen, gerade  
Tubing clamps resp. haemostatic forceps, straight



**HSE 023-12**  
**Halstead-Mosquito**  
120 mm

CE

**HSE 025-14**  
**Halstead-Mosquito**  
140 mm  
gebogen  
curved

CE

Arterien- und Gefäßklemmen  
Artery and clamp forceps



**HSE 029-12  
Mosquito**  
120 mm  
CE  
gebogen  
curved



**HSE 028-12  
Mosquito**  
120 mm  
CE

Gefäßklemmen, atraumatisch, gerade  
Clamp forceps, atraumatic, straight



**HSE 045-14  
Kelly**  
140 mm  
CE  
gebogen  
curved

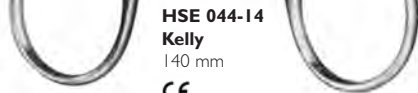

**HSE 044-14  
Kelly**  
140 mm  
CE

Arterien- und Gefäßklemme, gerade  
Artery and clamp forceps, straight



**HSE 049-14  
Crile**  
140 mm  
CE  
gebogen  
curved



**HSE 048-14  
Crile**  
140 mm  
CE

Arterien- und Gefäßklemme, gerade  
Artery and clamp forceps, straight



**HSE 064-14  
Pean**  
140 mm  
CE  
gerade  
straight

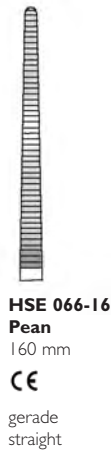

**HSE 066-16  
Pean**  
160 mm  
CE  
gerade  
straight



**HSE 062-13  
Pean**  
130 mm  
CE

Schlauchklemmen bzw. Arterienklemmen, gerade  
Tubing clamps resp. haemostatic forceps, straight



**HSE 065-14  
Pean**  
140 mm  
CE  
gebogen  
curved

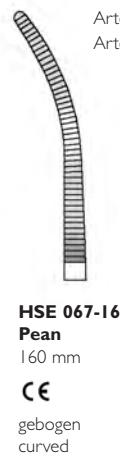

**HSE 067-16  
Pean**  
160 mm  
CE  
gebogen  
curved



**HSE 063-13  
Pean**  
130 mm  
CE

Schlauchklemmen bzw. Arterienklemmen, gebogen  
Tubing clamps resp. haemostatic forceps, curved

Alle mit CE gekennzeichneten Produkte sind Medizinprodukte. | All products marked with CE are medical devices.



**HSE 300-08  
Backhaus**  
80 mm  
CE

**HSE 302-13  
Backhaus**  
130 mm  
CE

Tuchklemmen  
Towel clamps

**Tuchklemmen, Wundhaken  
Towel clamps, retractors**



**HSJ 165-02  
Mundkeile McKesson**  
für Erwachsene  
for adults  
1 VE = 2 Stück  
1 package = 2 pieces

**HSJ 164-01  
Mundkeile McKesson**  
für Kinder  
for children  
1 VE = 2 Stück  
1 package = 2 pieces

**HSJ 163-00  
Mundkeile McKesson**  
für Kleinkinder  
for small children  
1 VE = 2 Stück  
1 package = 2 pieces

*wironit*

✓ nichtrostend	✓ rust resistant
✓ antimagnetisch	✓ anti-magnetic
✓ säurebeständig	✓ acid resistant
✓ formschön	✓ beautifully designed
✓ leicht in der Hand	✓ light in the hand
✓ von langer Lebensdauer	✓ unlimited durability



**HWF 020-12  
Farabeuf**  
120 mm  
CE

Wundhakensatz  
Set of retractors

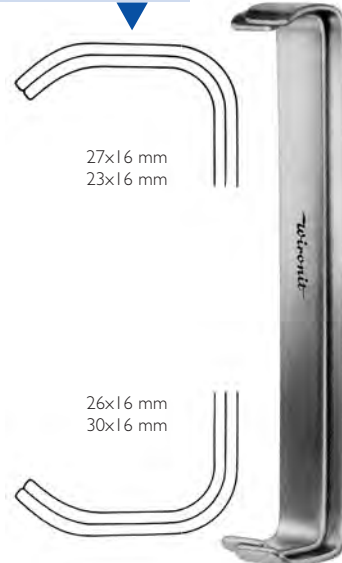

**HWF 021-15  
Farabeuf**  
150 mm  
CE

Wundhakensatz  
Set of retractors

Alle mit CE gekennzeichneten Produkte sind Medizinprodukte. | All products marked with CE are medical devices.

Wundhaken, Wangen- und Lippenabhalter  
Retractors, cheek and lip retractors

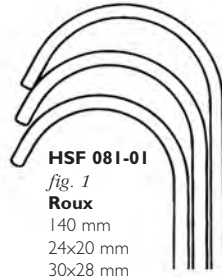

**HSF 081-01**  
*fig. 1*  
**Roux**  
140 mm  
24x20 mm  
30x28 mm

CE

**HSF 082-02**  
*fig. 2*  
**Roux**  
150 mm  
29x26 mm  
36x36 mm

CE

**HSF 083-03**  
*fig. 3*  
**Roux**  
165 mm  
33x29 mm  
38x43 mm

CE



**HSF 080-00**  
**Roux**  
Wundhakensatz  
Set of retractors

CE

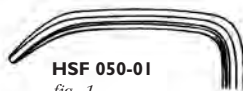

**HSF 050-01**  
*fig. 1*  
30x11 mm

CE

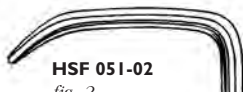

**HSF 051-02**  
*fig. 2*  
30x14 mm

CE

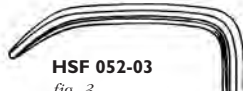

**HSF 052-03**  
*fig. 3*  
30x16 mm

CE



**HSF 053-04**  
*fig. 4*  
40x11 mm

CE



**HSF 054-05**  
*fig. 5*  
50x11 mm

CE



**HSF 050-01 -  
HSF 054-05**  
*fig. 1-5*  
**Langenbeck**  
210 mm

CE



**HSF 091-14**  
**Cawood-Minnesota**  
140 mm  
Wangen- und Lippenabhalter  
Cheek and lip retractor

CE

Wangen- und Lippenabhalter  
Cheek and lip retractors

**HSF 092-15**  
Lippenabhalter  
Lip retractor  
CE

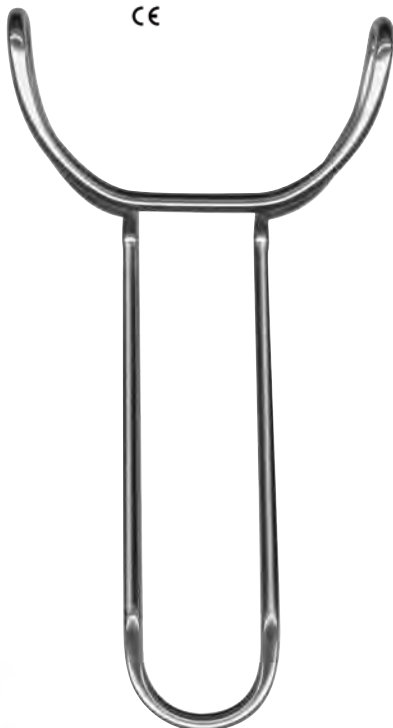

**HSF 093-15**  
Vestibulum  
150 mm  
Wangenhalter / Vestibulum-Haken  
Cheek retractor / Vestibulum hook  
CE



**HSF 093-16**  
Vestibulum  
160 mm  
Wangen- und Lippenabhalter / Vestibulum-Haken –  
für das gesamte Vestibulum des Ober- und Unterkiefers  
Cheek and lip retractor / Vestibule-hook –  
for the entire vestibule of the upper and lower jaws  
CE



**HSF 094-12**  
Sternberg  
120 mm

**HSF 095-14**  
Sternberg  
140 mm

**HSF 096-16**  
Sternberg  
160 mm  
Lippenhalter  
Lip retractors

CE



Mundsperrer, Wangen- und Lippenabhalter  
Mouth gags, cheek and lip retractors



**HSJ 204-11**  
**Molt**  
110 mm  
Mundsperrer für Kinder  
Mouth gags for children

CE

**HSJ 204-90**  
Ersatzgummis (Paar) Silikon zu  
HSJ 204-11 und HSJ 205-14  
Replacement tip from Silikon (pair) for  
HSJ 204-11 and HSJ 205-14

CE



**HSJ 205-14**  
**Molt**  
140 mm  
Mundsperrer für Erwachsene  
Mouth gags for adults

CE



**HSJ 203-13**  
**Denhart**  
130 mm  
Mundsperrer  
Mouth gags

CE

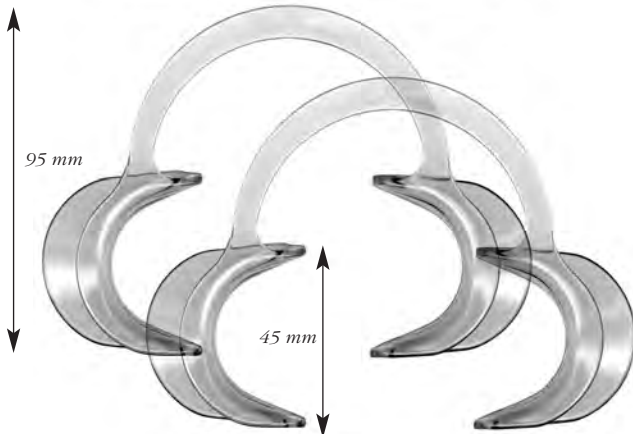
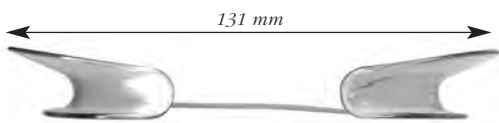

**HSF 100-01**  
sterilisierbar  
sterilizable

**Lippen- und Wangenhalter, Paar**

für Erwachsene, aus autoklavierbarem Polycarbonat. Durch elastischen Quersteg verbunden. Problemlos einzusetzen. Schafft freie Sicht und ein freies Arbeitsfeld. Ideal für Problempatienten und Kinder. Nichtreflektierend, ideal für Polaroid- und Intraoralaufnahmen. Zur Sterilisation empfehlen wir das Schonprogramm 121°C - darf nicht mit Metallinstrumenten in Berührung kommen!

**Lip and cheek retracor, pair**

for adults, made of autoclavable polycarbonat. Easy to snap into place. Allows a clear view and working area. Comfortable for the patient. Non-reflective, ideal for photography. For sterilization we recommend the safety programme of 121°C - please avoid metal instrument contact.

CE

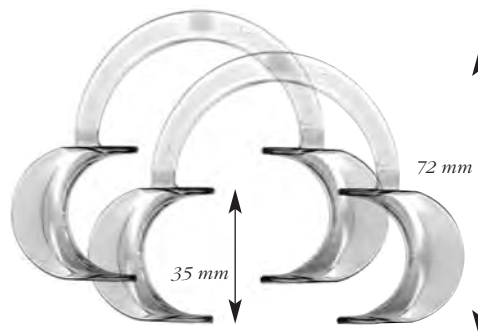
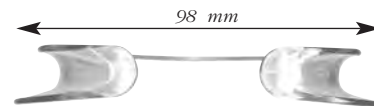

**HSF 100-02**  
sterilisierbar  
sterilizable

**Lippen- und Wangenhalter, Paar**

für Kinder; aus autoklavierbarem Polycarbonat. Durch elastischen Quersteg verbunden. Problemlos einzusetzen. Schafft freie Sicht und ein freies Arbeitsfeld. Ideal für Problempatienten und Kinder. Nichtreflektierend, ideal für Polaroid- und Intraoralaufnahmen. Zur Sterilisation empfehlen wir das Schonprogramm 121°C - darf nicht mit Metallinstrumenten in Berührung kommen!

**Lip and cheek retracor, pair**

for children, made of autoclavable polycarbonat. Easy to snap into place. Allows a clear view and working area. Comfortable for the patient. Non-reflective, ideal for photography. For sterilization we recommend the safety programme of 121°C - please avoid metal instrument contact.

CE

Raspatorien  
Raspatories

Kombiniertes Raspatorium zum Lösen der Papillen, des Gingivarands (mit dem lanzenförmigen Ende) und des Schleimhautperiostlappens (mit dem runden Arbeitseende).

Combined raspatory for the release of the papilla, the gingival margins (with the lancet working end) and the mucoperiosteal flaps (with round working end).

Das gelochte Arbeitseende wird zum Durchnähen genutzt. Das ungelochte Arbeitseende dient zum sicheren Abhalten des Gewebelappens.

The punched tip is used for sewing through. The non punched tip serves for the safe holding of the tissue flap.



**HSK 004-19**  
**Freer-Yasargil**  
190 mm  
sterilisierbar / sterilizable  
CE

Die schlanke Form ermöglicht ein besonders schonungsvolles und atraumatisches Abpräparieren der Gingiva und des Schleimhautperiostlappens.  
The slim design makes a particularly gentle and atraumatic removal of the gingiva and the mucoperiosteal flaps possible.

**HSK 011-08**  
*fig. 8*  
**Molt**  
180 mm  
sterilisierbar / sterilizable  
CE

**HWK 005-24**  
*fig. 24GSP*  
175 mm  
sterilisierbar / sterilizable  
CE

**HSK 006-09**  
*fig. 9A*  
**Allen**  
190 mm  
sterilisierbar / sterilizable  
CE

**HSK 008-03**  
*fig. PR-3S*  
**Prichard**  
210 mm  
sterilisierbar / sterilizable  
CE

**HSK 011-09**  
*fig. 9*  
**Molt**  
190 mm  
sterilisierbar / sterilizable  
CE

Zum Abhalten- und Zurückhalten des Mucoperiostlappens  
For retracting and reflecting the mucoperiosteum  
Para la retracción del mucoperiosteum  
Pour décoller et retenir les lambeaux  
Per la ritrazione e riflettere del mucoperiosteum

**HSK 003-09**  
*fig. 9H*  
**Howard**  
190 mm  
Raspatorium  
Raspatory  
CE

Raspatorien + Elevatorien  
Raspatories + elevators



**HWK 003-18**  
**Freer**  
180 mm  
Elevatorium  
Periosteal elevator  
CE



**HWK 011-16**  
**Williger**  
170 mm  
Raspatorium  
Raspatory  
CE



**HSK 011-03**  
*fig. 3*  
**Molt**  
190 mm  
Raspatorium  
Raspatory  
CE



**HSK 012-24**  
*fig. 2-4*  
**Molt**  
190 mm  
Raspatorium  
Raspatory  
CE



**HSK 015-17**  
**Clev-Dent**  
170 mm  
Raspatorium  
Raspatory  
CE



**HSK 021-23**  
**Seldin**  
190 mm  
Raspatorium  
Raspatory  
CE



**HSK 040-01**  
*fig. 1 (85)*  
**Lucas**  
170 mm  
Raspatorium  
Raspatory  
CE



**HSK 041-02**  
*fig. 2 (86)*  
**Lucas**  
170 mm  
Raspatorium  
Raspatory  
CE

Raspatorien + Knochenfeilen  
Raspatories + bone files

**HSK 051-01**  
**Miller-Colburn**  
*fig. 1*  
170 mm

CE

**HSK 052-02**  
**Miller-Colburn**  
*fig. 2*  
170 mm

CE

**HSK 053-03**  
**Miller-Colburn**  
*fig. 3*  
170 mm

CE

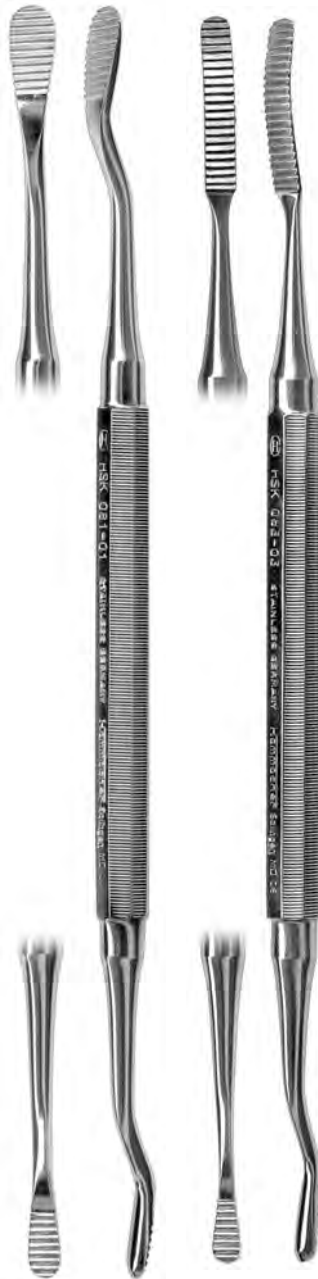
Raspatorium  
Raspatory

**HSK 081-01**  
**Miller-Colburn**  
*fig. 1*  
180 mm

CE

**HSK 083-03**  
**Miller-Colburn**  
*fig. 3*  
180 mm

CE

Knochenfeilen  
Bone files

**HSK 033-00**  
**Buser**  
170 mm

CE

Raspatorium  
Raspatories

**HSK 034-00**  
**Goldman Fox**  
175 mm

CE

Raspatorium  
Raspatories

**HSK 018-17**  
**Kramer Nevins**

CE

Raspatorium  
Raspatory

Scharfe Löffel  
Bone curettes



**HWK 030-04**  
160 mm  
CE

**HWK 031-05**  
160 mm  
CE

**HWK 035-04**  
160 mm  
CE

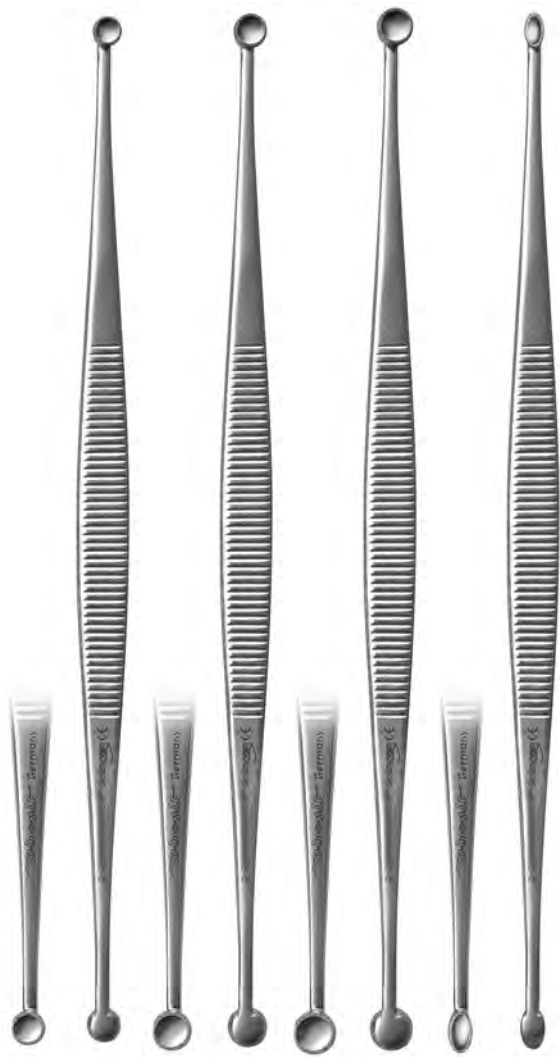

**HWK 040-01 Martini**  
135 mm  
Ø 3 mm  
Ø 3,5 mm  
CE

**HWK 041-02 Martini**  
135 mm  
Ø 3,5  
Ø 4 mm  
CE

**HWK 042-03 Martini**  
135 mm  
Ø 4 mm  
Ø 4,5 mm  
CE

**HWK 045-01 Williger**  
135 mm  
3,5 x 2,5 mm  
4 x 3 mm  
CE

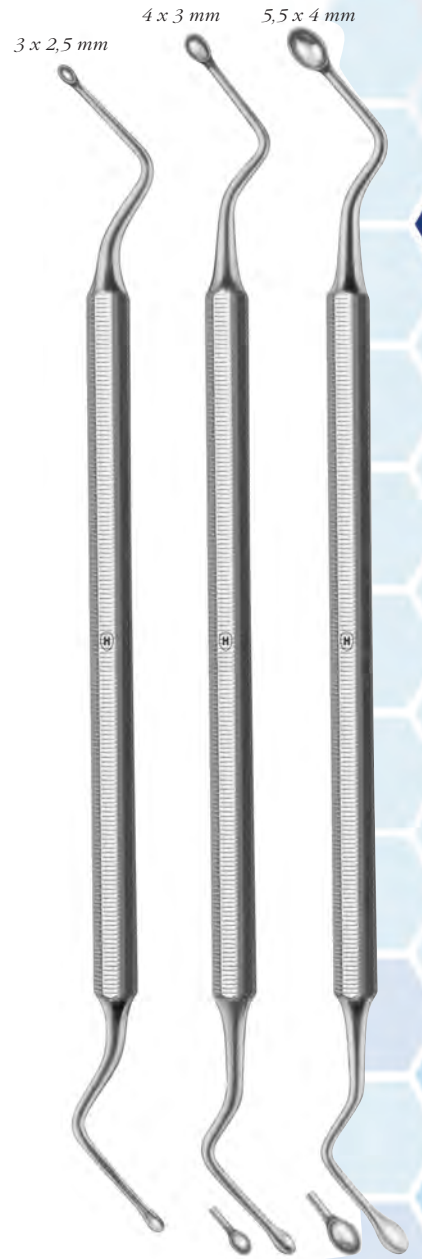

**HSK 115-00**  
*fig. 0*  
**Hemingway**  
175 mm  
CE

**HSK 116-01**  
*fig. 1*  
**Hemingway**  
175 mm  
CE

**HSK 117-02**  
*fig. 2*  
**Hemingway**  
175 mm  
CE

Flachmeißel, Hohlmeißel + Hämmer  
Chisels, gouges + mallets

2 mm



**HSK 301-01**  
*fig. 1*  
**Coupland**  
140 mm  
Hohlmeißel  
Gouges  
CE

2,5 mm



**HSK 302-02**  
*fig. 2*  
**Coupland**  
140 mm  
Hohlmeißel  
Gouges  
CE



**HSK 221-10**  
165 mm  
Ø 20 mm, 100 g  
Hämmer, massiv  
Mallets, solid  
CE



**HSK 220-14**  
165 mm  
Ø 20 mm, 140 g  
Hämmer mit Bleifüllung  
Mallets, lead filled  
CE



**HSK 222-01**  
**Mead**  
185 mm  
Hammer mit auswechselbaren Backen  
Mallet with interchangeable inserts  
CE

**HSK 223-00**  
Ersatzbacken zu HSK 222-01, Paar  
Inserts, only for HSK 222-01, pair  
CE

**Hohlmeißelzangen** mit feinen Arbeitsenden zur Verwendung in schwer zugänglichen Bereichen  
**Bone rongeurs** with small beaks for use in limited-access areas



Nadelhalter  
Needle holder

**HSD 004-14**  
**Mathieu-Kocher**  
140 mm  
Mathieu Nadelhalter  
mit Innensperre  
Mathieu needle holder  
with interior barrier  
CE



**HSD 005-14**  
**Mathieu-Kocher**  
140 mm  
Nadelhalter; schlankes Maul  
Needle holder; slender jaws  
CE



**HSD 009-14**  
**Mathieu**  
140 mm  
Nadelhalter  
Needle holder  
CE



**HSD 030-15**  
**Crile**  
150 mm  
Nadelhalter  
Needle holder  
CE



**HSD 071-13**  
**Halsey**  
135 mm  
Nadelhalter; Maul gerieft  
Needle holder; serrated jaws  
CE



**HSD 083-15**  
**Crile-Murrey**  
150 mm  
Nadelhalter  
Needle holder  
CE

Alle mit CE gekennzeichneten Produkte sind Medizinprodukte. | All products marked with CE are medical devices.



Nadelhalter  
Needle holder



**HSD 084-15**  
**Crile-Wood**  
150 mm  
Nadelhalter  
Needle holder  
CE



**HSD 098-18**  
**Mayo-Hegar-Grazil**  
180 mm  
CE



**HSD 091-16**  
**Mayo-Hegar**  
160 mm  
CE



**HSD 097-16**  
**Mayo-Hegar-Grazil**  
160 mm  
Nadelhalter; schlank  
Needle holder; delicate  
CE



**HSD 170-14**  
**Tungsten Carbide Inserts (TC)**  
**Mathieu-Kocher**  
140 mm  
Nadelhalter; schlankes Maul  
Needleholder; with slender jaws  
CE

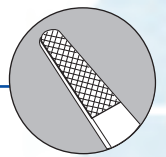

Nadelhalter mit  
Hartmetalleinlagen  
haben eine lange  
gleichmäßige  
Schnitthaltigkeit.

Needleholders with  
tungsten carbide  
inserts have a  
uniform long lasting  
cut.

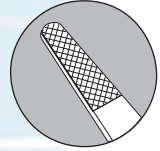

Nadelhalter mit  
Hartmetalleinlagen  
haben eine lange  
gleichmäßige  
Schnitthaltigkeit.

Needleholders with  
tungsten carbide  
inserts have a  
uniform long lasting  
cut.

### Nadelhalter Needle holder



**HSD 179-14  
Mathieu-Kocher**  
140 mm  
Mathieu Nadelhalter  
mit Innensperre  
Mathieu needle holder  
with interior barrier

CE



**HSD 179-17  
Mathieu-Kocher**  
170 mm  
CE



**HSD 205-18  
Toennis**  
180 mm  
Nadelhalter, ohne Sperre  
Needleholder, without ratchet

CE



**HSD 218-16  
Olsen-Hegar**  
165 mm  
Nadelhalter; mit scherenförmigen Maulteilen  
Needle holder with scissors-like jaws

CE



**HSD 227-13  
Halsey**  
130 mm  
Nadelhalter, geriefetes Maul  
Needleholder, serrated jaws

CE



**HSD 229-13  
Kilner**  
135 mm  
Nadelhalter  
Needleholder

CE



**HSD 236-14  
Hegar-Baumgartner**  
140 mm  
Nadelhalter  
Needleholder

CE

Alle mit CE gekennzeichneten Produkte sind Medizinprodukte. | All products marked with CE are medical devices.

Nadelhalter  
Needle holder



**HSD 237-15**  
**Baby-Crile-Wood**  
150 mm  
Nadelhalter  
Needleholder

CE



**HSD 238-15**  
**Crile-Wood**  
150 mm  
Nadelhalter  
Needleholder

CE



**HSD 243-15**  
**Crile-Wood**  
150 mm  
Nadelhalter  
Needleholder

CE

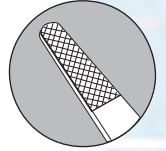

Nadelhalter mit  
Hartmetalleinlagen  
haben eine lange  
gleichmäßige  
Schnitthaltigkeit.

Needleholders with  
tungsten carbide  
inserts have a  
uniform long lasting  
cut.



**HSD 246-15**  
150 mm  
Nadelhalter; grazil, schwedisches Modell  
Needle holder; delicate, Swedish pattern

CE



**HSD 248-16**  
**Mayo-Hegar**  
160 mm

CE

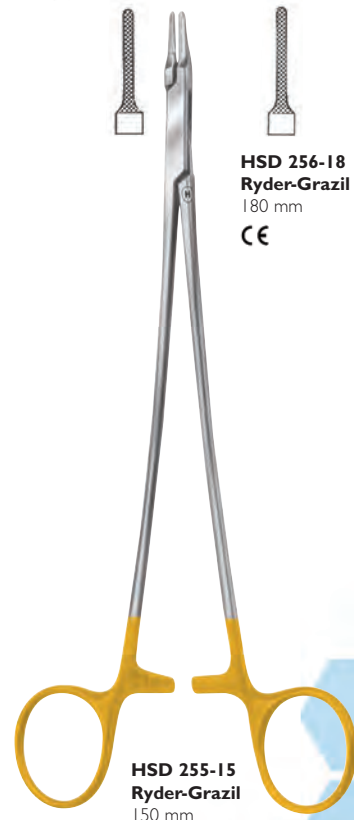

**HSD 256-18**  
**Ryder-Grazil**  
180 mm

CE



**HSD 247-14**  
**Mayo-Hegar**  
140 mm  
Nadelhalter  
Needleholder

CE



**HSD 255-15**  
**Ryder-Grazil**  
150 mm  
Nadelhalter; sehr schlankes Maul  
Needleholder; very slender jaws

CE

Alle mit CE gekennzeichneten Produkte sind Medizinprodukte. | All products marked with CE are medical devices.

Mikro-Nadelhalter  
Micro needle holder

**HSD 124-14**  
**Castroviejo**  
140 mm  
Mikro-Nadelhalter  
Micro-needleholder  
CE



**HSD 126-14**  
**Castroviejo**  
140 mm  
gebogen  
curved  
CE



**HSD 127-14**  
**Castroviejo**  
140 mm  
gebogen, gerieft  
curved, serrated  
CE



**HSD 128-14**  
**Castroviejo**  
140 mm  
gerade, gerieft  
straight, serrated  
CE



**HSD 310-14**  
**Castroviejo**  
140 mm  
Mikro-Nadelhalter; mit Sperre  
und **Hartmetall-Einlagen**  
Micro-needleholder; with ratchet  
and TC inserts  
CE

Mikro-Nadelhalter  
Micro needle holder



**HSD 314-18**  
**Castroviejo**  
180 mm  
Mikro-Nadelhalter  
**mit Hartmetall-Einlagen**  
Micro needle holder  
with TC inserts  
CE

**HSD 316-18**  
180 mm  
Mikro-Nadelhalter; Rundgriff, mit Sperre,  
**diamantiertes Maul**, gerade  
Micro needle holder; round handle, with  
ratchet, **diamond coated jaws**, straight  
CE

**HSD 317-18**  
180 mm  
Mikro-Nadelhalter; Rundgriff, mit Sperre,  
**diamantiertes Maul**, gebogen  
Micro needle holder; round handle, with  
ratchet, **diamond coated jaws**, curved  
CE

**HSD 336-18**  
**Barraquer**  
180 mm / 7 inch  
Mikro-Nadelhalter  
Micro needle holder  
CE

**HSD 338-18**  
**Barraquer**  
180 mm / 7 inch  
Mikro-Nadelhalter  
Micro needle holder  
CE

**Chirurgische Nadeln** | aus rostfreiem Stahl | in Packungen zu 12 Stück  
**Suture needles** | from stainless steel | in packages of 12 pcs.



**HSD 430-10**  
*fig. 10*  
CE



**HSD 446-10**  
*fig. 10*  
CE



**HSD 462-10**  
*fig. 10*  
CE



**HSD 478-10**  
*fig. 10*  
CE



**HSD 431-11**  
*fig. 11*  
CE



**HSD 447-11**  
*fig. 11*  
CE



**HSD 463-11**  
*fig. 11*  
CE



**HSD 479-11**  
*fig. 11*  
CE



**HSD 432-12**  
*fig. 12*  
CE



**HSD 448-12**  
*fig. 12*  
CE



**HSD 464-12**  
*fig. 12*  
CE



**HSD 480-12**  
*fig. 12*  
CE



**HSD 433-13**  
*fig. 13*  
CE



**HSD 449-13**  
*fig. 13*  
CE



**HSD 465-13**  
*fig. 13*  
CE



**HSD 481-13**  
*fig. 13*  
CE



**HSD 434-14**  
*fig. 14*  
CE



**HSD 450-14**  
*fig. 14*  
CE



**HSD 466-14**  
*fig. 14*  
CE



**HSD 482-14**  
*fig. 14*  
CE



**HSD 435-15**  
*fig. 15*  
CE



**HSD 451-15**  
*fig. 15*  
CE



**HSD 467-15**  
*fig. 15*  
CE



**HSD 483-15**  
*fig. 15*  
CE



**HSD 436-16**  
*fig. 16*  
CE



**HSD 452-16**  
*fig. 16*  
CE



**HSD 468-16**  
*fig. 16*  
CE



**HSD 484-16**  
*fig. 16*  
CE

Chirurgische Nadeln, Form **G**, 1/2 Kreis  
Suture needles form **G**, 1/2 circle

Chirurgische Nadeln, Form **B**, 3/8 Kreis  
Suture needles form **B**, 3/8 circle

Chirurgische Nadeln, Form **G**, 1/2 Kreis  
Suture needles form **G**, 1/2 circle

Chirurgische Nadeln, Form **B**, 3/8 Kreis  
Suture needles form **B**, 3/8 circle

Alle mit CE gekennzeichneten Produkte sind Medizinprodukte. | All products marked with CE are medical devices.

# PARASORB<sup>®</sup> Fleece PARASORB<sup>®</sup> Fleece HD



Die resorbierbaren Kollagenschwämme von Resorba dienen der lokalen Hämostase nach Zahnextraktionen und anderen kieferchirurgischen Eingriffen. Die hochdichten Resorba Dentalkollagene wirken als Platzhalter und reduzieren somit das Einwachsen von Bindegewebe. Im Falle einer potentiellen Infektionsgefahr mit einem additiven Antibiotikaschutz erhältlich.

#### Produkteigenschaften:

- ✦ Aufnahme großer Flüssigkeitsmengen aufgrund der schwammartigen Struktur
- ✦ schnelle und sichere Hämostase
- ✦ einfach zu schneiden und anzupassen

Resorba resorbable collagen sponges are used for local hemostasis after tooth extraction and other orthodontic surgery. The high-density Resorba dental collagens act as placeholders and thus reduce the ingrowth of connective tissue. In case of a potential risk of infection available with an additive antibiotic protection.

#### Product features:

- ✦ absorption of large quantities of liquid due to the sponge-like structure
- ✦ fast and safe hemostasis
- ✦ easy to cut and customize

PARASORB <sup>®</sup> Fleece	Artikel-Nr. Article-No.	Größe Size	Packungsinhalt package contents
<ul style="list-style-type: none"> <li>✦ enthält equine, native Kollagenfibrillen</li> <li>✦ contains equine, native collagen fibrils</li> </ul>	DK-1836	1,8 x 3,6 cm	12 Fleece
	DK-9001	7,0 x 3,0 cm	5 Fleece

PARASORB <sup>®</sup> Fleece HD	Artikel-Nr. Article-No.	Größe Size	Packungsinhalt package contents
<ul style="list-style-type: none"> <li>✦ hochkonzentriertes Kollagen für größere Defekte, enthält equine, native Kollagenfibrillen</li> <li>✦ highly concentrated collagen for larger defects contains equine, native collagen fibrils</li> </ul>	DK-8001	7,0 x 3,0 cm	5 Fleece

## PARASORB® Cone



Die Verwendung von Kollagenprodukten zum Aufbau und Erhalt von Knochensubstanz ist seit vielen Jahren Bestandteil der Standardtherapie in der Zahnmedizin und Kieferchirurgie. Der hunderttausendfache Einsatz von RESORBA® Dentalkegeln belegt die Wirksamkeit und Verlässlichkeit dieser Produkte.

The use of collagen products to build and maintain bone has been part of standard therapy in dentistry and oral surgery for many years. The hundred thousand uses of RESORBA® dental cones prove the effectiveness and reliability of these products.

PARASORB® Cone	Artikel-Nr. Article-No.	Größe Size	Packungsinhalt package contents
<ul style="list-style-type: none"> <li>* enthält equine, native Kollagenfibrillen</li> <li>* contains equine, native collagen fibrils</li> </ul>	DK-1010	Ø max. 1,2 cm / H: 1,6 cm	10 Cones

## PARASORB® Cone Genta



Kollagenkegel zur Verminderung der Alveolarkammatrophie nach Zahnextraktionen (socket preservation) – lokales Hämostyptikum mit antibiotischem Schutz.

Collagen cone for the reduction of alveolar ridge atrophy after tooth extraction (socket preservation) – local hemostyptic with antibiotic protection.

PARASORB® Cone	Artikel-Nr. Article-No.	Größe Size	Packungsinhalt package contents
<ul style="list-style-type: none"> <li>* enthält equine, native Kollagenfibrillen</li> <li>* contains equine, native collagen fibrils</li> </ul>	MK 10	Ø max. 1,2 cm / H: 1,6 cm	10 Cones



# PARASORB RESODONT<sup>®</sup>

## PARASORB RESODONT<sup>®</sup> Forte



An jede Membran im Bereich der GTR / GBR (Guided Tissue Regeneration und Guided Bone Regeneration) werden hohe Anforderungen gestellt. Hierzu zählen vor allem die Biokompatibilität, die Integration im umliegenden Gewebe, das interoperative Handling sowie die Dauer der Barrierefunktion. Die unterschiedlichen Membransysteme besitzen alle Voraussetzungen, um die Anforderungen des Anwenders mit einem positiven Ergebnis zu erfüllen.

### Produkteigenschaften:

- \* beidseitig verwendbar
- \* keine Fixierung notwendig
- \* schnelles, einfaches Zurechtschneiden und Applikation
- \* schnelle Integration im umgebenden Gewebe
- \* vollständig resorbierbar – ein Zweiteingriff zur Entfernung der Membran ist nicht notwendig
- \* spezielle Mikrostruktur

Each membrane in the area of GTR / GBR (Guided Tissue Regeneration and Guided Bone Regeneration) is subject to high demands. These include biocompatibility, integration in the surrounding tissue, interoperative handling and the duration of the barrier function. The different membrane systems have all the prerequisites to meet the requirements of the user with a positive result.

### Product features:

- \* usable on both sides
- \* no fixation necessary
- \* quick, easy trimming and application
- \* fast integration in the surrounding tissue
- \* completely resorbable – a second intervention to remove the membrane is not necessary
- \* special microstructure

### PARASORB RESODONT<sup>®</sup>

- \* besteht aus equinen, nativen Kollagenfibrillen
- \* sehr gute Modellierbarkeit, besonders im feuchten Zustand
- \* natürliche Quervernetzung
- \* hohe Reißfestigkeit
- \* einfaches Handling

- \* consists of equine, native collagen fibrils
- \* very good modelling, especially when wet
- \* natural cross-linking
- \* high tear resistance
- \* easy handling

Artikel-Nr. Article-No.	Größe Size	Packungsinhalt package contents
----------------------------	---------------	------------------------------------

<b>RD-3503</b>	3,2 x 2,5 cm	1 Membran
<b>RD-2502</b>	2,5 x 2,2 cm	1 Membran

### PARASORB RESODONT<sup>®</sup> Forte

- \* besteht aus equinen, nativen Kollagenfibrillen in höherer Konzentration
- \* sehr hohe Reißfestigkeit
- \* deutlich verlängerte Standzeit, ohne chemische Zusätze
- \* einfaches Zuschneiden im trockenen und feuchten Zustand

- \* consists of equine, native collagen fibrils in higher concentrations
- \* very high tear resistance
- \* significantly extended service life, without chemical additives
- \* easy cutting in dry and wet condition

Artikel-Nr. Article-No.	Größe Size	Packungsinhalt package contents
----------------------------	---------------	------------------------------------

<b>RDF-3503</b>	3,2 x 2,5 cm	1 Membran
<b>RDF-2502</b>	2,5 x 2,2 cm	1 Membran
<b>RDF-1502</b>	1,6 x 2,5 cm	1 Membran

## Nadelcode / Needle code

### 1. Buchstabe: gibt die Nadelkrümmung an

F = 5/8-kreisförmig  
H = 1/2-kreisförmig  
D = 3/8-kreisförmig  
V = 1/4-kreisförmig  
K = 1/2-kreis/kufenförmig  
A = Asymptotisch  
G = Gerade

### 1st letter: indicates the curvature of the needle

F = 5/8-circle  
H = 1/2-circle  
D = 3/8-circle  
V = 1/4-circle  
K = semicurved  
A = asymptotic  
G = straight

### 2. Buchstabe: gibt Auskunft über die Ausführung des Nadelkörpers und der Spitze

R = Rundkörper-Nadel  
S = Schneidende Nadel

### 2nd letter: gives information on the type of needle and needle tip

R = round bodied needle  
S = cutting needle

### 3+4. Buchstabe: Bezeichnet die Sonderformen des Nadelkörpers und der Spitze

M = PREMIUM-Schliff (z.T. Handschliff)  
N = Stumpfe Spitze  
T = Schneidende Spitze (DIAMOND)  
P = Spatula-Nadel (PREMIUM/DIAMOND)  
S = stärkerer Durchmesser  
X = extra starker Durchmesser  
F = feiner PREMIUM-Schliff "THIN LINE" (z.T. Handschliff)

### 3rd and 4th letters: describe special features of the needle and needle tip

M = PREMIUM cut (partly hand-honed)  
N = blunt point  
T = trocar point  
P = spatulated needle  
S = stronger diameter  
X = extra strong diameter  
F = thin PREMIUM cut "THIN LINE" (partly hand-honed)

### Zahlen geben gestreckte Länge der Nadel (Bogenlänge) in Millimeter an

S (nach Zahlen) = stärkerer Durchmesser  
F (nach Zahlen) = extra feiner Durchmesser

### Numbers indicate the straight (extended) length of the needle in millimetres

S (after numbers) = stronger diameter  
F (after numbers) = extra thin diameter

H R X 30

## Nadelkrümmung / Needle curvature

5/8-Kreis = F    1/2-Kreis = H    3/8-Kreis = D    1/4-Kreis = V    Kufen-Form = K    gerade = G    Asymptotisch = A  
5/8-circle = F    1/2-circle = H    3/8-circle = D    1/4-circle = V    semicurved = K    straight = G    asymptotic = A



## Nadelformen / Needle shapes

### 1. Spatula Nadel ◻ = P

1/2-, 3/8- oder 1/4- kreisförmig  
oder gerade = HSPM, DSPM, VSPM

- \* Für Augen- und Mikrochirurgie
- \* Abgeflachter Nadelkörper
- \* PREMIUM-Schliff
- \* Seitlich schneidend

### 1. Spatula needle ◻ = P

1/2-circle, 3/8-circle, 1/4-circle,  
or straight = HSPM, DSPM, VSPM

- \* For use in ophthalmic surgery and microsurgery
- \* Needle cross-section flattened
- \* PREMIUM cut
- \* Cuts on lateral edges



### 2. Stumpfe Rundkörpernadel ○ = RN

1/2-, 3/8- kreisförmig oder  
1/2-gebogen = HRN, DRN, KRN

- \* Für Parenchymgewebe, Cervix und Muskelzüge am Auge
- \* Stumpfe Nadelspitze
- \* Kein Durchstechen von Gefäßen oder Sehnen

### 2. Blunt round-bodied needle ○ = RN

1/2-circle, 3/8-circle or semicurved  
= HRN, DRN, KRN

- \* For use in parenchymal tissue, the cervix, and muscle traction in the eye
- \* Needle tip blunt
- \* No puncturing of vessels or tendons



### 3. Außen schneidende Nadel ▼ = S

1/2-, 3/8-kreisförmig, 1/2-gebogen  
oder gerade = HS, DS, KS, GS, FS

- \* Für festes Gewebe, wie z.B. Haut
- \* Dreieckiger Nadelquerschnitt
- \* z.T. mit PREMIUM-Schliff M, MF und MFX erhältlich

### 3. Reverse cutting needle ▼ = S

1/2-circle, 3/8-circle, semicurved  
or straight = HS, DS, KS, GS, FS

- \* For use in firm tissue such as skin
- \* Triangular needle cross-section
- \* Also available with PREMIUM cut needles M, MF, and MFX



### 4. Rundkörpernadel ● = R

5/8-, 1/2-, 3/8-kreisförmig oder  
gerade = FR, HR, DR, GR

- \* Für weiches Gewebe (subcutan), wie Muskel, Faszie, Schleimhaut
- \* Zum besseren Sitz des Nadelhalters ist der Nadelkörper im mittleren Bereich abgeflacht
- \* Leichter Einstich

### 4. Round-bodied needle ● = R

5/8-circle, 1/2-circle, 3/8-circle  
or straight = FR, HR, DR, GR

- \* For use in soft tissue (subcutaneous) such as muscle, fascia, mucosa
- \* In order to improve grip by the needle holder, the cross-section of the middle part of the needle is flattened
- \* Easy insertion

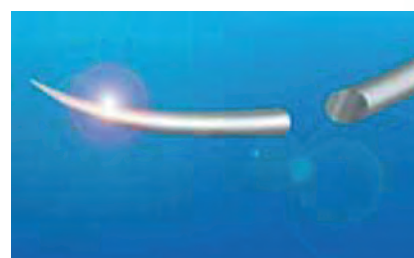

### 5. Schneidende Rundkörpernadel

◻● = RT

1/2-, 3/8-kreisförmig oder gerade  
= HRT, DRT, GRT, ART

- \* Für festes Gewebe, sklerotische Gefäße und Prothesen
- \* Nadelspitze dreikantig bzw. vierkantig geschliffen, daher enger Stichkanal, durchdringt Gewebe wie - Nadel (z.T. mit PREMIUM-Schliff erhältlich)

### 5. Round-bodied cutting needle

◻● = RT

1/2-circle, 3/8-circle or straight  
= HRT, DRT, GRT, ART

- \* For use in firm tissue, sclerotic vessels, and implants
- \* Needle tip triangular or square in section, therefore small puncture channel, penetrates tissue like a - needle (also available with PREMIUM cut)



## Chirurgisches Nahtmaterial

Chirurgisches Nahtmaterial dient als typisches Medizinprodukt zur Reparatur von Geweben. Noch immer werden die meisten Wundverschlüsse mit Nähten ausgeführt. Dabei ist die mechanische Eigenschaft der eingesetzten Materialien von größter Bedeutung, um die verlorene Festigkeit zeitweilig zu ersetzen. Die Nahtmaterialien von RESORBA® zeigen aufgrund der Verarbeitung bioverträglicher Rohstoffe bestmögliche Gewebeverträglichkeit und ermöglichen den Einsatz bei jeder Art der Wundversorgung.

### Surgical sutures

Surgical sutures serve as a typical medical device for repairing tissues. Most wound closures are still done with sutures. Here, the mechanical property of the materials used is of utmost importance to replace the lost strength temporarily. Due to the processing of biocompatible raw materials, the suture materials of RESORBA® show the best possible tissue compatibility and enable use in all types of wound care.



## GLYCOLON®

Zur Herstellung von GLYCOLON® werden die beiden Materialbestandteile Polyglykolsäure und  $\epsilon$ -Caprolacton in einem bestimmten Verhältnis polymerisiert. Der Abbau des polymeren Fadensmaterials im Gewebe erfolgt durch Wasseraufnahme in Umkehrung der Synthese.

Nach Implantation nimmt die Reißkraft von GLYCOLON® nach 7 Tagen auf 30% ab.

Gewebereaktionen werden zum einen durch die dabei entstehenden unbedenklichen Zwischenprodukte, zum anderen durch die monofile und glatte Oberflächenstruktur des Fadens minimiert.

GLYCOLON® besitzt durch die glatten und monofilen Oberflächenstrukturen des Polymers ausgezeichnete Eigenschaften bezüglich des Handlings und der Gleitfähigkeit. Gewebetraumatisierungen durch den Fadendurchzug sind bei GLYCOLON® nicht relevant und die monofile Struktur verhindert eine Dochtwirkung des Fadens ohne zusätzliche Oberflächenbehandlung.

#### Eigenschaften:

- ✦ kurzfristig resorbierbares Monofilament
- ✦ hohe Reißkraft
- ✦ guter Knotensitz
- ✦ atraumatischer Gewebedurchzug

For the production of GLYCOLON®, the two constituents of polyglycolic acid and  $\epsilon$ -caprolactone are co-polymerized in a certain ratio. The degradation of the polymeric thread material in the tissue takes place by water absorption in reversal of the synthesis.

After implantation, the tear strength of GLYCOLON® decreases to 30% after 7 days. Fabric reactions are minimized on the one hand by the resulting harmless intermediates, on the other hand by the monofilament and smooth surface structure of the thread.



















Due to the smooth and monofilament surface structures of the polymer, GLYCOLON® has excellent handling and lubricity properties. Tissue trauma due to thread passage is not relevant for GLYCOLON® and the monofilament structure prevents wicking of the thread without additional surface treatment.

#### Characteristics:

- ✦ monofilamentat, short term absorbable
- ✦ high breaking strength
- ✦ good knot security
- ✦ atraumatic tissue passage

# GLYCOLON<sup>®</sup>



Produkt Product	Beschreibung Description	Artikel-Nr. Article- No.	Inhalt Content
GLYCOLON <sup>®</sup> ORAL	DSM13 ▽ DSM 13  5/0 USP, 45 cm	DB15002S	12 St./pcs.
GLYCOLON <sup>®</sup> ORAL	DSM18 ▽ DSM 18  5/0 USP, 45 cm	DB15003S	12 St./pcs.
GLYCOLON <sup>®</sup> violet	HR12 ● HR 12  6/0 USP, 45 cm	PB40204	24 St./pcs.
GLYCOLON <sup>®</sup> violet	HR17 ● HR 17  5/0 USP, 70 cm	PB40201	24 St./pcs.
GLYCOLON <sup>®</sup> violet	HRT16 ◐ HRT16  5/0 USP, 45 cm	PB40602	24 St./pcs.
GLYCOLON <sup>®</sup> violet	HRT18 ◐ HRT 18  4/0 USP, 70 cm	PB40605	24 St./pcs.
GLYCOLON <sup>®</sup> violet	HRT22 ◐ HRT 22  4/0 USP, 70 cm	PB40613	24 St./pcs.
GLYCOLON <sup>®</sup> violet	DS18 ▼ DS 18  4/0 USP, 45 cm	PB41420	24 St./pcs.
GLYCOLON <sup>®</sup> violet	DS18 ▼ DS 18  5/0 USP, 45 cm	PB41421	24 St./pcs.
GLYCOLON <sup>®</sup> violet	DS18 ▼ DS 18  4/0 USP, 70 cm	PB41416	24 St./pcs.
GLYCOLON <sup>®</sup> violet	DSM11 ▽ DSM 11  6/0 USP, 45 cm	PB41512	24 St./pcs.
GLYCOLON <sup>®</sup> undyed	DSM11 ▽ DSM 11  6/0 USP, 45 cm	PB41502	24 St./pcs.
GLYCOLON <sup>®</sup> violet	DSM13 ▽ DSM 13  5/0 USP, 45 cm	PB41503	24 St./pcs.
GLYCOLON <sup>®</sup> violet	DSM13 ▽ DSM 13  5/0 USP, 70 cm	PB41507	24 St./pcs.
GLYCOLON <sup>®</sup> violet	DSM13 ▽ DSM 13  4/0 USP, 45 cm	PB41508	24 St./pcs.
GLYCOLON <sup>®</sup> violet	DSM16 ▽ DSM 16  5/0 USP, 45 cm	PB41509	24 St./pcs.
GLYCOLON <sup>®</sup> undyed	DSM16 ▽ DSM 16  4/0 USP, 45 cm	PB41510	24 St./pcs.
GLYCOLON <sup>®</sup> violet	DSM16 ▽ DSM 16  4/0 USP, 45 cm	PB41511	24 St./pcs.

Alle mit CE gekennzeichneten Produkte sind Medizinprodukte. | All products marked with CE are medical devices.

## PGA-Resorba®

**PGA RESORBA®** ist ein Polymer der Glykolsäure. Die linear hochmolekulare Polyglykolsäure wird unter Einwirkung eines Katalysators über das Zwischenprodukt Glykolid, einem zyklischen Ester, synthetisiert.

Der Abbau des PGA-Fadenmaterials im Gewebe erfolgt durch Wasseraufnahme in Umkehrung der Synthese. Die monomere Glykolsäure wird durch den normalen Stoffwechsel enzymatisch in  $\text{CO}_2$  und  $\text{H}_2\text{O}$  gespalten. Fadenmaterial mit einem Anteil von 10% Lactid als Copolymer unterscheidet sich in seinem physikalischen und physiologischen Verhalten nur geringfügig von reinen PGA-Fäden.

Die feinen, präzisionsgeflochtenen Filamente gewähren eine sehr hohe Reißfestigkeit sowie eine ausgezeichnete Geschmeidigkeit. Die spezielle Beschichtung legt sich fein um die Faserbündel und führt zu einer gezielten Herabsetzung der Oberflächenreibung. Resorbierbare Nahtmaterialien adaptieren das Gewebe während der Heilungsphase und verlieren dabei zunehmend ihre Zugfestigkeit und Reißkraft.

Bei PGA RESORBA® führen die präzisionsgeflochtenen Filamente aus Polyglykolsäure zu einem standardisierten, mittelfristigen Resorptionsverhalten im Gewebe. 18 Tage nach Implantation liegt die Reißkraft von PGA RESORBA® bei 50% der ursprünglichen Reißkraft. Violettes PGA RESORBA® ist mit einem physiologisch unbedenklichen Farbstoff gefärbt.

### Produkteigenschaften:

- \* multifil, mittelfristige Gewebeunterstützung
- \* hohe Reißkraft
- \* gutes Handling
- \* guter Knotensitz
- \* atraumatischer Gewebedurchzug
- \* minimale Gewebereaktion

**PGA RESORBA®** is a polymer of glycolic acid. The linear high molecular weight polyglycolic acid is synthesized under the action of a catalyst via the intermediate glycolide, a cyclic ester.

The degradation of the PGA thread material in the tissue takes place by water uptake in reversal of the synthesis. The monomeric glycolic acid is enzymatically cleaved by the normal metabolism into  $\text{CO}_2$  and  $\text{H}_2\text{O}$ . Thread material with a content of 10% lactide as co-polymer differs only slightly in its physical and physiological behavior from pure PGA threads.



The fine, precision braided filaments provide a very high tear strength and excellent suppleness. The special coating finely wraps around the fiber bundles and leads to a targeted reduction of surface friction. Absorbable sutures adapt the tissue during the healing phase and increasingly lose their tensile strength and tear strength.

With PGA RESORBA®, the precision braided filaments of polyglycolic acid lead to a standardized, medium-term resorption behavior in the tissue. 18 days after implantation, the tensile strength of PGA RESORBA® is 50% of the original tensile strength. Violet PGA RESORBA® is dyed with a physiologically harmless dye.

### Product features:

- \* multifilament, medium term wound support
- \* high breaking strength
- \* good handling
- \* good knot security
- \* atraumatic tissue passage
- \* minimal tissue reaction



Produkt Product	Beschreibung Description	Artikel-Nr. Article- No.	Inhalt Content
PGA-RESOQUICK undyed	HR17 ● HR 17  4/0 USP, 70 cm	PRN30204	24 St./pcs.
PGA-RESOQUICK undyed	HS18 ▼ HS 18  4/0 USP, 45 cm	PRN31103	24 St./pcs.
PGA-RESOQUICK undyed	DS18 ▼ DS 18  5/0 USP, 45 cm	PRN31405	24 St./pcs.
PGA-RESORBA violett	HR12 ● HR 12  6/0 USP, 70 cm	PA1021	24 St./pcs.
PGA-RESORBA violett	HR17 ● HR 17  5/0 USP, 70 cm	PA1024	24 St./pcs.
PGA-RESORBA violett	HR17 ● HR 17  4/0 USP, 70 cm	PA1025	24 St./pcs.
PGA-RESORBA violett	HR17 ● HR 17  3/0 USP, 70 cm	PA1026	24 St./pcs.
PGA-RESORBA violett	HRT18 ◐ HRT 18  4/0 USP, 70 cm	PA1060	24 St./pcs.
PGA-RESORBA violett	DRT12 ◐ DRT 12  6/0 USP, 45 cm	PA1081	24 St./pcs.
PGA-RESORBA undyed	DS18 ▼ DS 18  4/0 USP, 45 cm	PA1141	24 St./pcs.
PGA-RESORBA violett	DS18 ▼ DS 18  3/0 USP, 70 cm	PA11416	24 St./pcs.
PGA-RESORBA violett	DS18 ▼ DS 18  5/0 USP, 45 cm	PA11417	24 St./pcs.
PGA-RESORBA violett	DS18 ▼ DS 18  4/0 USP, 45 cm	PA11418	24 St./pcs.
PGA-RESORBA undyed	DSM13 ▽ DSM 13  5/0 USP, 45 cm	PA1151	24 St./pcs.
PGA-RESORBA undyed	DSM11 ▽ DSM 11  6/0 USP, 45 cm	PA1158	24 St./pcs.
PGA-RESORBA violett	ART25 ◐ ART 25  4/0 USP, 45 cm	PA1281	24 St./pcs.



Alle mit CE gekennzeichneten Produkte sind Medizinprodukte. | All products marked with CE are medical devices.

## SEIDE / SILK

Der Rohstoff für die Seidenherstellung ist das Gespinnst (Kokon) der Seidenspinnerraupe. Diese feinsten Kokonfäden werden entbastet (von der Kittsubstanz Sericin befreit), versponnen und präzisionsgeflochten. Durch Oberflächenbehandlung wird der Seidenfaden imprägniert. Man erhält damit eine Seide ohne unerwünschte Dochtwirkung, also einen nichtkapillaren, Wasser abstoßenden Faden mit glatter Oberfläche. SEIDE ist mit physiologisch unbedenklichen Farbstoffen eingefärbt. Farbe: schwarz

### Produkteigenschaften:









- \* hohe Geschmeidigkeit
- \* hervorragendes Knüpfverhalten
- \* guter Knotensitz
- \* geringe Sägewirkung

The raw material for silk production is the web (cocoon) of the silkworm caterpillar. These finest cocoon threads are unbastened (freed of the putty substance sericin), spun and precision braided. By surface treatment, the silk thread is impregnated. This gives a silk without unwanted wicking, so a non-capillary, water-repellent thread with a smooth surface. SILK is dyed with physiologically harmless dyes. Colour: black

### Product features:





- \* high suppleness
- \* excellent knotting behavior
- \* good knot security
- \* low sawing effect



Produkt Product	Beschreibung Description	Artikel-Nr. Article- No.	Inhalt Content
SEIDE / SILK	<b>GR20</b> ● GR 20  4/0 USP, 45 cm	<b>016483HDN</b>	24 St./pcs.
SEIDE / SILK	<b>HR12</b> ● HR 12  4/0 USP, 45 cm	<b>4024N</b>	24 St./pcs.
SEIDE / SILK	<b>HR17</b> ● HR 17  5/0 USP, 75 cm	<b>4026N</b>	24 St./pcs.
SEIDE / SILK	<b>HR17</b> ● HR 17  4/0 USP, 45 cm	<b>036483HDN</b>	12 St./pcs.
SEIDE / SILK	<b>HR17</b> ● HR 17  4/0 USP, 75 cm	<b>4027N</b>	24 St./pcs.
SEIDE / SILK	<b>HR17</b> ● HR 17  3/0 USP, 45 cm	<b>036484HDN</b>	12 St./pcs.
SEIDE / SILK	<b>HR17</b> ● HR 17  3/0 USP, 75 cm	<b>4028N</b>	24 St./pcs.
SEIDE / SILK	<b>HR22</b> ● HR 22  4/0 USP, 75 cm	<b>40219N</b>	24 St./pcs.
SEIDE / SILK	<b>HR22</b> ● HR 22  3/0 USP, 45 cm	<b>40266HDN</b>	12 St./pcs.
SEIDE / SILK	<b>HR22</b> ● HR 22  2/0 USP, 45 cm	<b>035485HDN</b>	12 St./pcs.



# SEIDE / SILK

Produkt Product	Beschreibung Description	Artikel-Nr. Article- No.	Inhalt Content
SEIDE / SILK	HRT25  3/0 USP, 75 cm	40610N	24 St./pcs.
SEIDE / SILK	HRT18  4/0 USP, 45 cm	4062HDN	12 St./pcs.
SEIDE / SILK	HRT18  4/0 USP, 45 cm	4062N	24 St./pcs.
SEIDE / SILK	HRT18  3/0 USP, 45 cm	4063HDN	12 St./pcs.
SEIDE / SILK	HRT18  3/0 USP, 45 cm	4063N	24 St./pcs.
SEIDE / SILK	DRT18  3/0 USP, 75 cm	4083N	24 St./pcs.
SEIDE / SILK	GR20  4/0 USP, 45 cm	40918N	24 St./pcs.
SEIDE / SILK	HS12  5/0 USP, 45 cm	4111N	24 St./pcs.
SEIDE / SILK	HS18  4/0 USP, 45 cm	136483HDN	12 St./pcs.
SEIDE / SILK	HS18  4/0 USP, 45 cm	4112N	24 St./pcs.
SEIDE / SILK	HS18  3/0 USP, 45 cm	136484HDN	12 St./pcs.
SEIDE / SILK	HS18  3/0 USP, 45 cm	4113N	24 St./pcs.
SEIDE / SILK	HS18  2/0 USP, 45 cm	136485HDN	12 St./pcs.
SEIDE / SILK	HS22  3/0 USP, 45 cm	135484HDN	12 St./pcs.
SEIDE / SILK	HS22  3/0 USP, 45 cm	4116N	24 St./pcs.
SEIDE / SILK	HS22  2/0 USP, 45 cm	135485HDN	12 St./pcs.
SEIDE / SILK	DS16  5/0 USP, 45 cm	4148N	24 St./pcs.
SEIDE / SILK	DS16  4/0 USP, 45 cm	4149N	24 St./pcs.
SEIDE / SILK	DS18  5/0 USP, 45 cm	41411N	24 St./pcs.
SEIDE / SILK	DS18  4/0 USP, 45 cm	156483HDN	12 St./pcs.
SEIDE / SILK	DS18  4/0 USP, 45 cm	41412N	24 St./pcs.
SEIDE / SILK	DS18  3/0 USP, 45 cm	41413HDN	12 St./pcs.
SEIDE / SILK	DS18  3/0 USP, 45 cm	41413N	24 St./pcs.
SEIDE / SILK	DS21  3/0 USP, 45 cm	41432N	24 St./pcs.
SEIDE / SILK	DSM13  4/0 USP, 45 cm	41521HDN	12 St./pcs.
SEIDE / SILK	DSM13  4/0 USP, 45 cm	41521N	24 St./pcs.
SEIDE / SILK	DSM21  3/0 USP, 45 cm	41535N	24 St./pcs.

# RESOLON<sup>®</sup>

RESOLON<sup>®</sup> ist zunächst, wie NYLON, ein monofiler Polyamid-Faden, der jedoch im Herstellungsprozess einer speziellen Behandlung unterzogen wird. RESOLON<sup>®</sup> ist auch im trockenen sterilen Zustand überdurchschnittlich weich und geschmeidig. Dadurch ergeben sich für einen monofilen Faden hervorragende Handhabungs- und Knüpf Eigenschaften bei optimaler Knotenreißkraft - Farbe: blau.

#### Produkteigenschaften:

- \* überdurchschnittlich weich und geschmeidig
- \* sehr gute Handhabungs- und Knüpf Eigenschaften
- \* keine Kapillarität
- \* hervorragendes Gewebedurchzugsverhalten

RESOLON<sup>®</sup> is initially, like NYLON, a monofilament polyamide thread, but undergoes a special treatment in the manufacturing process. RESOLON<sup>®</sup> is also exceptionally soft and supple in the dry sterile state. This results in excellent handling and knotting properties with optimum knot-pull breaking strength for a monofilament thread - colour: blue.















#### Product features:

- \* highly soft and supple
- \* very good handling and knotting properties
- \* no capillarity
- \* excellent fabric pull-through behavior



Produkt Product	Beschreibung Description	Artikel-Nr. Article- No.	Inhalt Content
RESOLON <sup>®</sup>	HRT 18  HRT 18 4/0 USP, 45 cm	88061	36 St./pcs.
RESOLON <sup>®</sup>	HS 18  HS 18 5/0 USP, 45 cm	88112	36 St./pcs.
RESOLON <sup>®</sup>	HS 18  HS 18 5/0 USP, 45 cm	88112D	12 St./pcs.
RESOLON <sup>®</sup>	HS 18  HS 18 4/0 USP, 45 cm	88113D	12 St./pcs.
RESOLON <sup>®</sup>	DS 13  DS 13 6/0 USP, 45 cm	881430	36 St./pcs.
RESOLON <sup>®</sup>	DS 13  DS 13 5/0 USP, 45 cm	881431	36 St./pcs.
RESOLON <sup>®</sup>	DS 16  DS 16 6/0 USP, 45 cm	881440	36 St./pcs.
RESOLON <sup>®</sup>	DS 16  DS 16 5/0 USP, 45 cm	88141	36 St./pcs.
RESOLON <sup>®</sup>	DS 16  DS 16 5/0 USP, 45 cm	88141D	12 St./pcs.
RESOLON <sup>®</sup>	DS 16  DS 16 5/0 USP, 75 cm	881451	36 St./pcs.
RESOLON <sup>®</sup>	DS 16  DS 16 4/0 USP, 45 cm	88142	36 St./pcs.

Alle mit CE gekennzeichneten Produkte sind Medizinprodukte. | All products marked with CE are medical devices.

Produkt Product	Beschreibung Description	Artikel-Nr. Article- No.	Inhalt Content
RESOLON®	DS18 ▼ DS 18  5/0 USP, 45 cm	88143	36 St./pcs.
RESOLON®	DS18 ▼ DS 18  4/0 USP, 45 cm	88144	36 St./pcs.
RESOLON®	DS18 ▼ DS 18  4/0 USP, 45 cm	88144D	12 St./pcs.
RESOLON®	DS18 ▼ DS 18  4/0 USP, 75 cm	88145	36 St./pcs.
RESOLON®	DS21 ▼ DS 21  4/0 USP, 45 cm	88149	36 St./pcs.
RESOLON®	DSM11 ▼ DSM 11  6/0 USP, 45 cm	88151	36 St./pcs.
RESOLON®	DSM13 ▼ DSM 13  6/0 USP, 45 cm	88153	36 St./pcs.
RESOLON®	DSM13 ▼ DSM 13  5/0 USP, 45 cm	88154	36 St./pcs.
RESOLON®	DSM13 ▼ DSM 13  5/0 USP, 45 cm	88154D	12 St./pcs.
RESOLON®	DSM16 ▼ DSM 16  5/0 USP, 45 cm	88155	36 St./pcs.
RESOLON®	DSM16 ▼ DSM 16  5/0 USP, 45 cm	88155D	12 St./pcs.
RESOLON®	DSM16 ▼ DSM 16  4/0 USP, 45 cm	88156	36 St./pcs.
RESOLON®	DSM16 ▼ DSM 16  4/0 USP, 45 cm	88156D	12 St./pcs.
RESOLON®	DSM18 ▼ DSM 18  4/0 USP, 45 cm	88158	36 St./pcs.
RESOLON®	DSM18 ▼ DSM 18  4/0 USP, 45 cm	88158D	12 St./pcs.



Alle mit CE gekennzeichneten Produkte sind Medizinprodukte. | All products marked with CE are medical devices.

# SUPRAMID

**SUPRAMID** ist als monofiles, nicht-resorbierbares, chirurgisches Nahtmaterial aus einem Copolymerisat aus zwei Polyamiden erhältlich. In stärkeren Durchmessern wird es als pseudomonofiles nicht-resorbierbares, chirurgisches Nahtmaterial aus Polyamid 6.6, einem Polymer von Hexamethyldiamin und Adipinsäure, mit einer Beschichtung aus Polyamid 6, einem ε-Caprolactam-Polymer, angeboten.

**Besonderheit:** Trotz seiner synthetischen Herkunft, bedingt durch die peptidartige Struktur, unterliegt **SUPRAMID** nach längerem Verbleib im Gewebe der allmählichen Degradation und ist daher mit wenigen Ausnahmen nur für Hautnähte oder Gewebe, die keine permanenten Wundunterstützungen benötigen, geeignet. Das Material ist mit einem physiologisch unbedenklichen Farbstoff eingefärbt – Farbe: schwarz.

#### Produkteigenschaften:

- \* überdurchschnittlich weich und geschmeidig
- \* sehr gute Handhabungs- und Knüpfeigenschaften
- \* keine Kapillarität
- \* hervorragendes Gewebedurchzugsverhalten

**SUPRAMID** is available as a monofilament, non-resorbable surgical suture made from a co-polymer of two polyamides. In larger diameters, it is offered as a pseudomonofiles non-absorbable surgical suture made of polyamide 6.6, a polymer of hexamethylenediamine and adipic acid, with a coating of polyamide 6, a ε-caprolactam polymer.

**Special feature:** Despite its synthetic origin, due to the peptide-like structure, **SUPRAMID** undergoes gradual degradation after prolonged retention in the tissue and, with few exceptions, is therefore only suitable for sutures or tissues that do not require permanent wound support. The material is dyed with a physiologically harmless dye – colour: black.

#### Product features:

- \* highly soft and supple
- \* very good handling and knotting properties
- \* no capillarity
- \* excellent fabric pull-through behavior



Produkt Product	Beschreibung Description	Artikel-Nr. Article- No.	Inhalt Content
SUPRAMID	HRT 18  4/0 USP, 50 cm	6061	36 St./pcs.
SUPRAMID	HRT 18  3/0 USP, 50 cm	6062	36 St./pcs.
SUPRAMID	HRT 18  4/0 USP, 75 cm	6063	36 St./pcs.
SUPRAMID	HS 15  4/0 USP, 45 cm	6118	36 St./pcs.
SUPRAMID	HS 18  5/0 USP, 45 cm	6111	36 St./pcs.
SUPRAMID	HS 18  4/0 USP, 45 cm	6112	36 St./pcs.
SUPRAMID	HS 18  4/0 USP, 45 cm	6112D	12 St./pcs.
SUPRAMID	HS 18  3/0 USP, 45 cm	6114	36 St./pcs.
SUPRAMID	HS 22  3/0 USP, 45 cm	6113	36 St./pcs.
SUPRAMID	DS 18  4/0 USP, 45 cm	6142	36 St./pcs.
SUPRAMID	DS 18  3/0 USP, 45 cm	6143	36 St./pcs.
SUPRAMID	DSM 13  4/0 USP, 45 cm	6154	36 St./pcs.
SUPRAMID	DSM 16  4/0 USP, 75 cm	6153	36 St./pcs.

Alle mit CE gekennzeichneten Produkte sind Medizinprodukte. | All products marked with CE are medical devices.

# POLYESTER



**POLYESTER** wird durch Polykondensation von Ethylenglykol und Terephthalsäure hergestellt. Die Faserbildung erfolgt nach dem Trockenspinnverfahren. Anschließend werden die gereckten, leicht verdrehten Faserbündel zu einem Faden präzisionsgeflochten und getempert. Der einzelne Faden ist hydrophob, nimmt also kein Wasser auf. Das Material ist mit einem physiologisch unbedenklichen Farbstoff eingefärbt – Farbe: grün.

**Produkteigenschaften:**

- \* sehr hohe Reißfestigkeit
- \* hervorragende Fadengleitfähigkeit
- \* guter Knotensitz

**POLYESTER** is produced by polycondensation of ethylene glycol and terephthalic acid. The fibre formation takes place after the dry spinning process. Subsequently, the stretched, slightly twisted fibre bundles are precision braided into a thread and tempered. The single thread is hydrophobic, so does not absorb water. The material is dyed with a physiologically harmless dye – colour: green.

**Product features:**

- \* very high tear resistance
- \* excellent thread-sliding ability
- \* good knot security

Produkt Product	Beschreibung Description	Artikel-Nr. Article- No.	Inhalt Content
POLYESTER	<b>HR17</b> ● HR 17  4/0 USP, 75 cm	<b>8023</b>	36 St./pcs.
POLYESTER	<b>HR17</b> ● HR 17  5/0 USP, 75 cm	<b>8022</b>	36 St./pcs.
POLYESTER	<b>HR22</b> ● HR 22  4/0 USP, 75 cm	<b>80210</b>	36 St./pcs.
POLYESTER	<b>HRT18</b> ◐ HRT 18  5/0 USP, 45 cm	<b>8061D</b>	12 St./pcs.
POLYESTER	<b>HRT18</b> ◐ HRT 18  4/0 USP, 45 cm	<b>8062D</b>	12 St./pcs.
POLYESTER	<b>HRT18</b> ◐ HRT 18  3/0 USP, 45 cm	<b>7184174D</b>	12 St./pcs.
POLYESTER	<b>DS18</b> ▼ DS 18  3/0 USP, 45 cm	<b>81413</b>	36 St./pcs.
POLYESTER	<b>HS18</b> ▼ HS 18  2/0 USP, 45 cm	<b>8112D</b>	12 St./pcs.
POLYESTER	<b>ART25</b> ◐ ART 25  3/0 USP, 45 cm	<b>8283</b>	12 St./pcs.

# SUPOLENE

**SUPOLENE** wird, ebenso wie **POLYESTER**, durch Polykondensation von Ethylenglykol und Terephthalsäure hergestellt. Die Faserbildung erfolgt nach dem Trockenspinnverfahren. Anschließend wird der Faden präzisionsgeflochten, gefärbt, getempert und die Oberfläche durch Beschichtung des Fadens speziell veredelt. Durch diese Oberflächenbehandlung werden Kapillarität sowie Sägewirkung beim Gewebedurchzug und Knotenlauf auf ein Minimum reduziert. **SUPOLENE** ist hydrophob, also ohne Wasserabsorptionseigenschaften. Das Material ist mit einem physiologisch unbedenklichen Farbstoff eingefärbt – Farbe: grün.

#### Produkteigenschaften:







- \* hohe Reißfestigkeit
- \* hervorragende Fadengleitfähigkeit, keine Sägewirkung
- \* sehr gleichmäßige und glatte Oberflächenbeschaffenheit
- \* sehr geringe Gewebereaktion

**SUPOLENE**, like **POLYESTER**, is made by polycondensation of ethylene glycol and terephthalic acid. The fibre formation takes place after the dry spinning process. The thread is then precision braided, dyed, tempered and the surface is specially finished by coating the thread. By this surface treatment, capillarity and sawing effect on fabric passage and knot run are reduced to a minimum. **SUPOLENE** is hydrophobic, so without water absorption properties. The material is dyed with a physiologically harmless dye – colour: green.

#### Product features:

- \* high tear resistance
- \* excellent thread-sliding ability, no sawing
- \* very even and smooth surface texture
- \* very low tissue reaction



Produkt Product	Beschreibung Description	Artikel-Nr. Article- No.	Inhalt Content
SUPOLENE	HRT 18  5/0 USP, 45 cm	7184202D	12 St./pcs.
SUPOLENE	HRT 18  4/0 USP, 75 cm	9062	36 St./pcs.
SUPOLENE	HRT 18  4/0 USP, 45 cm	9062D	12 St./pcs.
SUPOLENE	HRT 18  3/0 USP, 75 cm	9063	36 St./pcs.
SUPOLENE	GR 20  3/0 USP, 45 cm	9091	36 St./pcs.
SUPOLENE	DS 18  3/0 USP, 45 cm	9146	36 St./pcs.
SUPOLENE	DSM 13  4/0 USP, 45 cm	9153	36 St./pcs.

# MOPYLEN®



MOPYLEN® ist ein synthetischer Faden, der durch Polymerisation von Propylen hergestellt wird. Die Herstellung des Fadens erfolgt aus dem gefärbten Granulat nach dem Trockenspinnverfahren. Der Faden ist hydrophob, hat also praktisch keine Wasserabsorption und ist chemisch inert.

MOPYLEN® ist ein idealer Hautfaden speziell für plastische Chirurgie und überall, wo es auf ein besonders gutes kosmetisches Ergebnis ankommt.

Das Material ist mit einem physiologisch unbedenklichen Farbstoff eingefärbt – Farbe: blau.

### Produkteigenschaften:

- \* guter Knotensitz
- \* dauerhaft hohe Reißfestigkeit
- \* hervorragende Fadengleitfähigkeit
- \* hydrophob
- \* alterungsbeständig





MOPYLEN® is a synthetic thread made by polymerizing propylene. The thread is produced from the dyed granules by the dry-spinning process. The thread is hydrophobic, so has virtually no water absorption and is chemically inert.

MOPYLEN® is an ideal skin thread especially for plastic surgery and everywhere, where it depends on a particularly good cosmetic result.

The material is dyed with a physiologically harmless dye - colour: blue.

### Product features:

- \* good knot security
- \* permanently high tear resistance
- \* excellent thread-sliding ability
- \* hydrophobic
- \* resistant to aging

Produkt Product	Beschreibung Description	Artikel-Nr. Article- No.	Inhalt Content
MOPYLEN®	HR17 ● HR 17  5/0 USP; 75 cm	7027	36 St./pcs.
MOPYLEN®	HRT18 ▼ HRT 18  5/0 USP; 75 cm	7061	36 St./pcs.
MOPYLEN®	HRT18 ▼ HRT 18  3/0 USP; 75 cm	7063	36 St./pcs.
MOPYLEN®	DS18 ▼ DS 18  4/0 USP; 45 cm	7148	36 St./pcs.



Alle mit CE gekennzeichneten Produkte sind Medizinprodukte. | All products marked with CE are medical devices.

## RESOTEX<sup>®</sup> ORAL + SUPRAMID ORAL



Moderne Nahtmaterialien erlauben die atraumatische Versorgung und genaue Adaption von Weichgewebswunden. Nahttechnik, Fadenmaterial und Fadenstärke, sowie Nadelspitze haben einen Einfluss auf die Reaktion des Gewebes. RESORBA bietet ein spezielles Nahtprogramm für die häufigsten oralchirurgischen Eingriffe in der täglichen Praxis.



### Produkteigenschaften:

- ✦ überdurchschnittlich geschmeidig und weich
- ✦ sehr gute Knüpfenschaften
- ✦ hervorragender Gewebedurchzug
- ✦ keine Kapillarität
- ✦ geringe Gewebereaktion
- ✦ mit silberner Nadel

Modern sutures allow atraumatic restoration and accurate adaptation of soft tissue wounds. Suture technique, thread material and thread strength, as well as needle tip have an influence on the reaction of the tissue. RESORBA offers a special suture program for the most common oral surgical procedures in daily practice.

### Product features:

- ✦ exceptionally supple and soft
- ✦ very good knotting properties
- ✦ excellent tissue penetration
- ✦ no capillarity
- ✦ low tissue reaction
- ✦ with silver needle

Produkt Product	Beschreibung Description	Artikel-Nr. Article- No.	Inhalt Content
RESOTEX <sup>®</sup> ORAL	HRT 18  HRT 18 	4/0 USP, 45 cm	DB22001S 12 St./pcs.
RESOTEX <sup>®</sup> ORAL	ART 13  ART 13 	6/0 USP, 45 cm	DB23001S 12 St./pcs.
RESOTEX <sup>®</sup> ORAL	DSM 13  DSM 13 	6/0 USP, 45 cm	DB25001S 12 St./pcs.
RESOTEX <sup>®</sup> ORAL	DSM 16  DSM 16 	4/0 USP, 45 cm	DB25002S 12 St./pcs.
RESOTEX <sup>®</sup> ORAL	DSM 16  DSM 16 	5/0 USP, 45 cm	DB25003S 12 St./pcs.
RESOTEX <sup>®</sup> ORAL	DSM 13  DSM 13 	7/0 USP, 45 cm	DB25004S 12 St./pcs.
RESOTEX <sup>®</sup> ORAL	DSM 13  DSM 13 	5/0 USP, 45 cm	DB25005S 12 St./pcs.
RESOTEX <sup>®</sup> ORAL	DSM 18  DSM 18 	5/0 USP, 45 cm	DB25006S 12 St./pcs.
RESOTEX <sup>®</sup> ORAL	DSM 11  DSM 11 	6/0 USP, 45 cm	DB25007S 12 St./pcs.
RESOTEX <sup>®</sup> ORAL	GR 22  GR 22 	4/0 USP, 45 cm	DB28001S 12 St./pcs.
SUPRAMID ORAL	HS 18  HS 18 	4/0 USP, 45 cm	DB31001S 12 St./pcs.
SUPRAMID ORAL	HRT 18  HRT 18 	4/0 USP, 45 cm	DB32001S 12 St./pcs.

Alle mit CE gekennzeichneten Produkte sind Medizinprodukte. | All products marked with CE are medical devices.



# Die Knotentechnik / Tying knots

**Elegant gelöst durch die speziellen, schlanken Nadelhalter:**

*Eine Kombination aus peel-fähiger Umverpackung und Multifunktionaler Innenverpackung.*

**Elegantly solved with the special, slim needle holder:**

*A combination of peelable outer sachet and multifunctional inner sachet*

Durch das Herumlegen des Fadens um den Nadelhalter wird die erste Schlinge gebildet. Placing the thread round the needle holder forms the first sling.

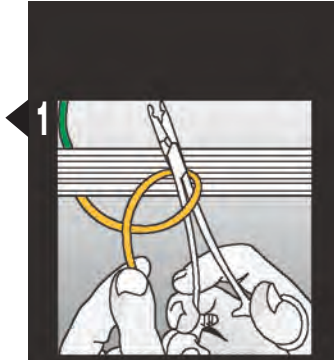

Der Nadelhalter zieht das kurze Faden-Ende durch die Schlinge - zum Operateur hin. The needle holder pulls the short thread end through the sling - towards the operator

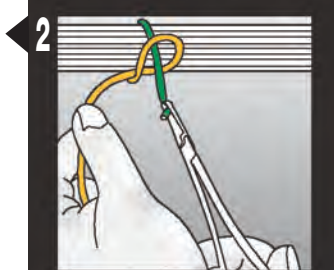

Der Knoten wird mit Hand oder Nadelhalter festgezogen. The knot is tightened, either by hand or with the needle holder

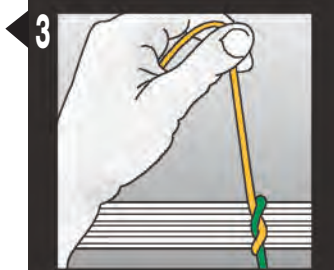

Zur 2. Schlinge zieht der Nadelhalter das kürzere Faden-Ende durch die Schlaufe des längeren Endes. For the second sling the needle holder pulls the short end of the thread through the loop of the longer end.

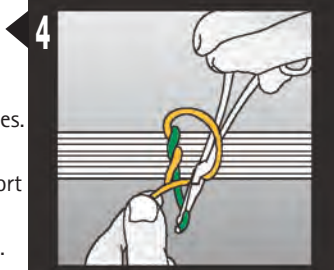

Der überkreuzte Knoten wird fixiert. The crossover knot being fixed.

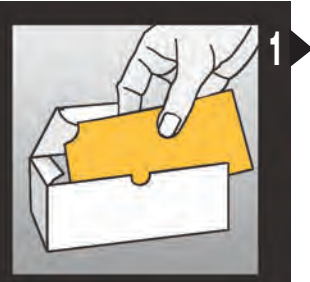
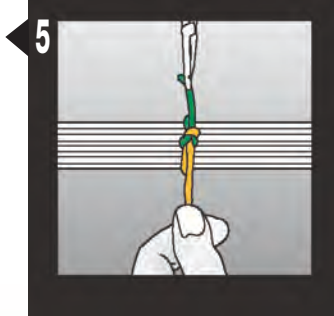

**1** Entnahme der Peel-Packung aus dem Vorratskarton. Remove the peel pack from the storage box.



**2** Der Springer greift die beiden Aufziehlaschen am oberen Ende der Packung und öffnet diese durch gleichmäßiges Peelen. The circulating nurse grasps the two tabs at the upper end of the pack and opens them by peeling them apart evenly.

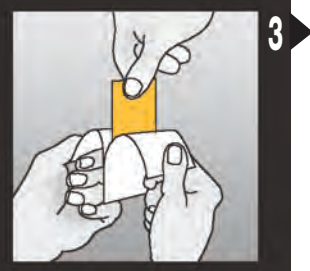

**3** Steriler Inhalt wird kontaminationsfrei angereicht. The sterile contents are passed to the surgeon without contaminating them.



**4** Beim Umklappen der perforierten Lasche wird die Nadel freigelegt. Diese wird anschließend mit dem Nadelhalter entnommen. The needle is exposed by folding back the perforated tab and then withdrawn with the needle holder.

## Handling



### Nadel fassen

Die Nadeln sollen in einer Distanz von ca. 3/4, von der Nadelspitze aus gesehen, gefaßt werden. Nicht an der Armierungszone fassen, damit diese und auch der Faden nicht verletzt werden.

Needles should be held approx. 3/4 away from the tip. Do not clamp where the suture is swaged to the needle to avoid waekening the needle and the suture.



### Faden strecken

Faden nach Herausnahme sachte strecken! Nicht schnell ziehen oder reiben, nicht an der Nadel fassen und strecken! Straighten the suture gently after removal. Do not rub it or pull it quickly, do not hold the needle and strctch!

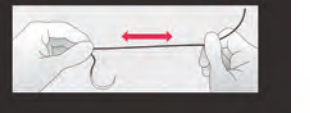

## Nahtmaterial Suture



### Naht- und Ligaturscheren

**Achtung:** alle Scheren sind auch mit feiner "HAARZAHNUNG" lieferbar, d. h. leichter Schnitt, kein Abrutschen

### Suture and ligature scissors

**Attention:** the scissors are deliverable also with "MICRO-TOOTHING", i. e. handy cutting, no slipping off

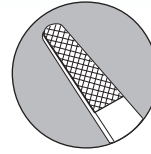

### Nadelhalter mit Hartmetalleinlagen

haben eine lange gleichmäßige Schnitthaltigkeit. Sie haben zur Kennzeichnung vergoldete Griffe

### Needleholders with tungsten carbide inserts

have a uniform long lasting cut. They are identified by gold-plated handles.



**HSB 284-09  
Spencer**  
90 mm

**HSB 286-12  
Spencer**  
115 mm  
gerade  
straight

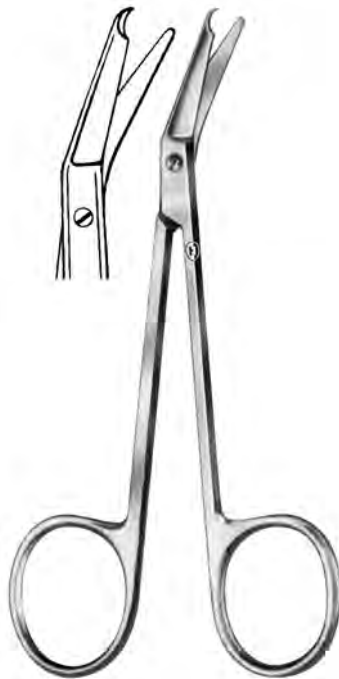

**HSB 287-11  
Spencer**  
115 mm  
abgewinkelt  
angled



**HSD 179-14  
Mathieu-Kocher**  
140 mm  
Mathieu Nadelhalter  
mit Innensperre  
Mathieu needle holder  
with interior barrier



**HSD 336-18  
Barraquer**  
180 mm / 7 inch  
Mikro-Nadelhalter  
Micro needle holder



**HSC 491-15**  
150 mm  
Nahtpinzette, gebogen  
Suture forceps, curved

CE

Alle mit CE gekennzeichneten Produkte sind Medizinprodukte. | All products marked with CE are medical devices.



Sterilisier- und Laborgefäße  
Sterilization and laboratory utensils



**HWM 083-00**  
170 x 100 x 35 mm

**HWM 084-00**  
250 x 140 x 40 mm  
Nierenschalen  
Kidney bowls



**HWM 087-10**  
10 cl  
Schalen  
Dishes



**HWM 088-25**  
25 cl  
Schalen  
Dishes



**HWM 031-00**  
50 x 27 x 10 mm  
Pellet-Behälter  
Pellet container



**HWM 032-00**  
48 x 27 x 9 mm  
Schale ohne Unterteilung  
Container without division



**HWM 032-01**  
50 x 24 x 10 mm  
Medikamentenschale  
Medicament cup



**HWM 064-00**  
50 x 100 mm

Standgefäße ohne Deckel  
Jars without lid



**Wironit Instrumente sind aus einer Speziallegierung gefertigt und weisen folgende Vorteile auf:**

- ✓ nichtrostend
- ✓ antimagnetisch
- ✓ säurebeständig

Sie sind formschön, liegen leicht in der Hand und sind von langer Lebensdauer.



**Wironit instruments are made of a special alloy and show the following advantages:**

- ✓ rust resistant
- ✓ anti-magnetic
- ✓ acid resistant

They are beautifully designed and of unlimited durability.

Pinzetten  
Forceps

Wironit Instrumente sind aus einer Speziallegierung gefertigt und weisen folgende Vorteile auf:

- ✓ nichtrostend
- ✓ antimagnetisch
- ✓ säurebeständig

Sie sind formschön, liegen leicht in der Hand und sind von langer Lebensdauer.



Wironit instruments are made of a special alloy and show the following advantages:

- ✓ rust resistant
- ✓ anti-magnetic
- ✓ acid resistant

They are beautifully designed and of unlimited durability.



**HWC 050-12**  
Standard  
120 mm

CE

**HWC 051-13**  
Standard  
130 mm

CE

**HWC 052-14**  
Standard  
145 mm

CE

**HWC 053-16**  
Standard  
160 mm

CE

Anatomische Pinzetten  
Dressing forceps



**HWC 070-10**  
105 mm

CE

**HWC 072-11**  
115 mm

CE

**HWC 074-13**  
130 mm

CE

Anatomische Pinzetten, fein  
Dressing forceps, delicates



**HWC 071-10**  
105 mm

CE

**HWC 073-11**  
115 mm

CE

**HWC 075-13**  
130 mm

CE

Anatomische Pinzetten,  
fein, gebogen  
Dressing forceps,  
delicates, curved



**HWC 082-14**  
Standard  
145 mm

CE

**HWC 083-16**  
Standard  
160 mm

CE

Chirurgische Pinzetten  
Tissue forceps



**HWC 090-10**  
105 mm

CE

Chirurgische Pinzetten, fein, gerade  
Tissue forceps, delicates, straight



**HWC 091-10**  
105 mm

CE

gebogen  
curved

Pinzetten  
Forceps

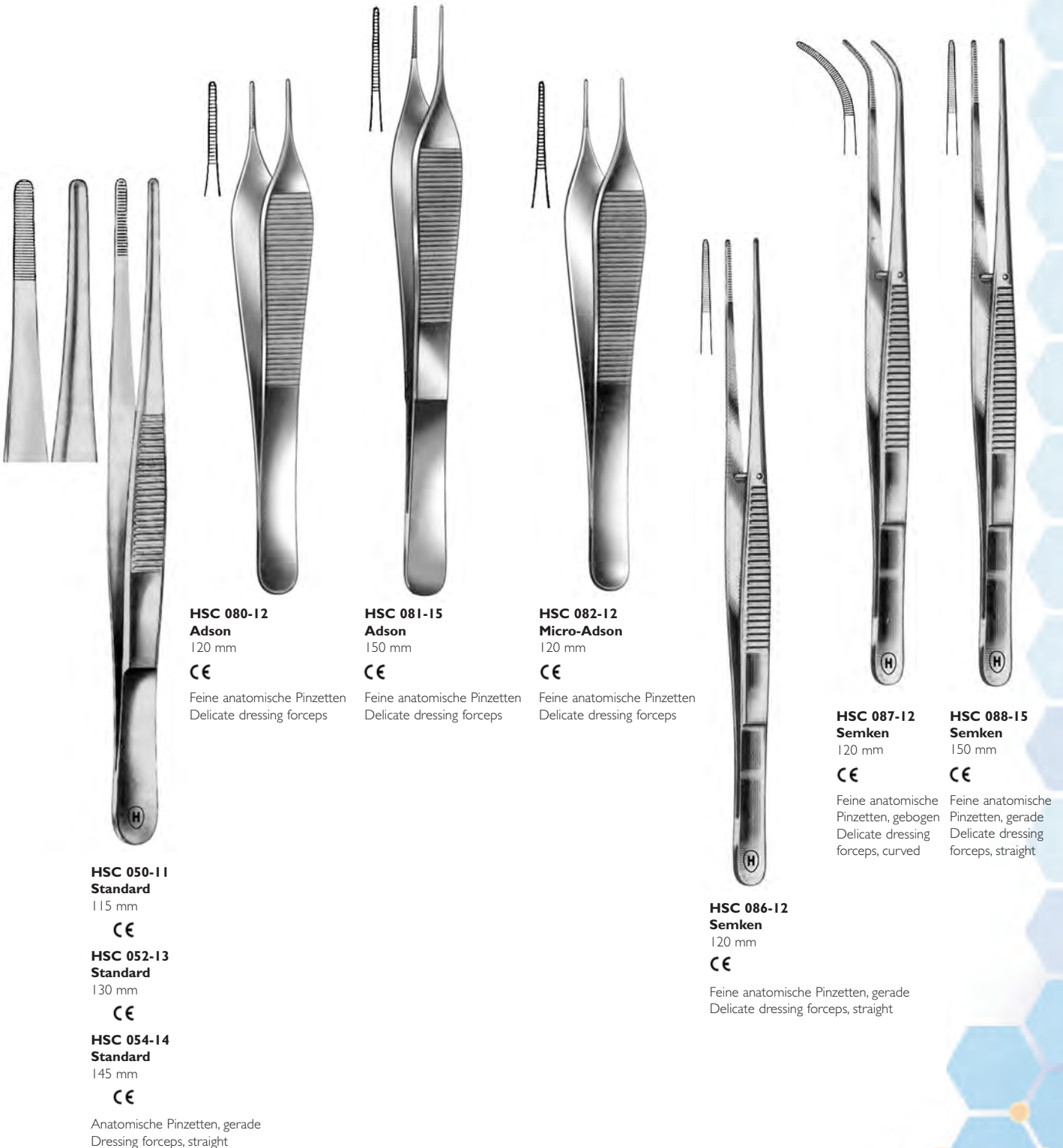

**HSC 050-11**  
Standard  
115 mm

CE

**HSC 052-13**  
Standard  
130 mm

CE

**HSC 054-14**  
Standard  
145 mm

CE

Anatomische Pinzetten, gerade  
Dressing forceps, straight

**HSC 080-12**  
Adson  
120 mm

CE

Feine anatomische Pinzetten  
Delicate dressing forceps

**HSC 081-15**  
Adson  
150 mm

CE

Feine anatomische Pinzetten  
Delicate dressing forceps

**HSC 082-12**  
Micro-Adson  
120 mm

CE

Feine anatomische Pinzetten  
Delicate dressing forceps

**HSC 086-12**  
Semken  
120 mm

CE

Feine anatomische Pinzetten, gerade  
Delicate dressing forceps, straight

**HSC 087-12**  
Semken  
120 mm

CE

Feine anatomische  
Pinzetten, gebogen  
Delicate dressing  
forceps, curved

**HSC 088-15**  
Semken  
150 mm

CE

Feine anatomische  
Pinzetten, gerade  
Delicate dressing  
forceps, straight

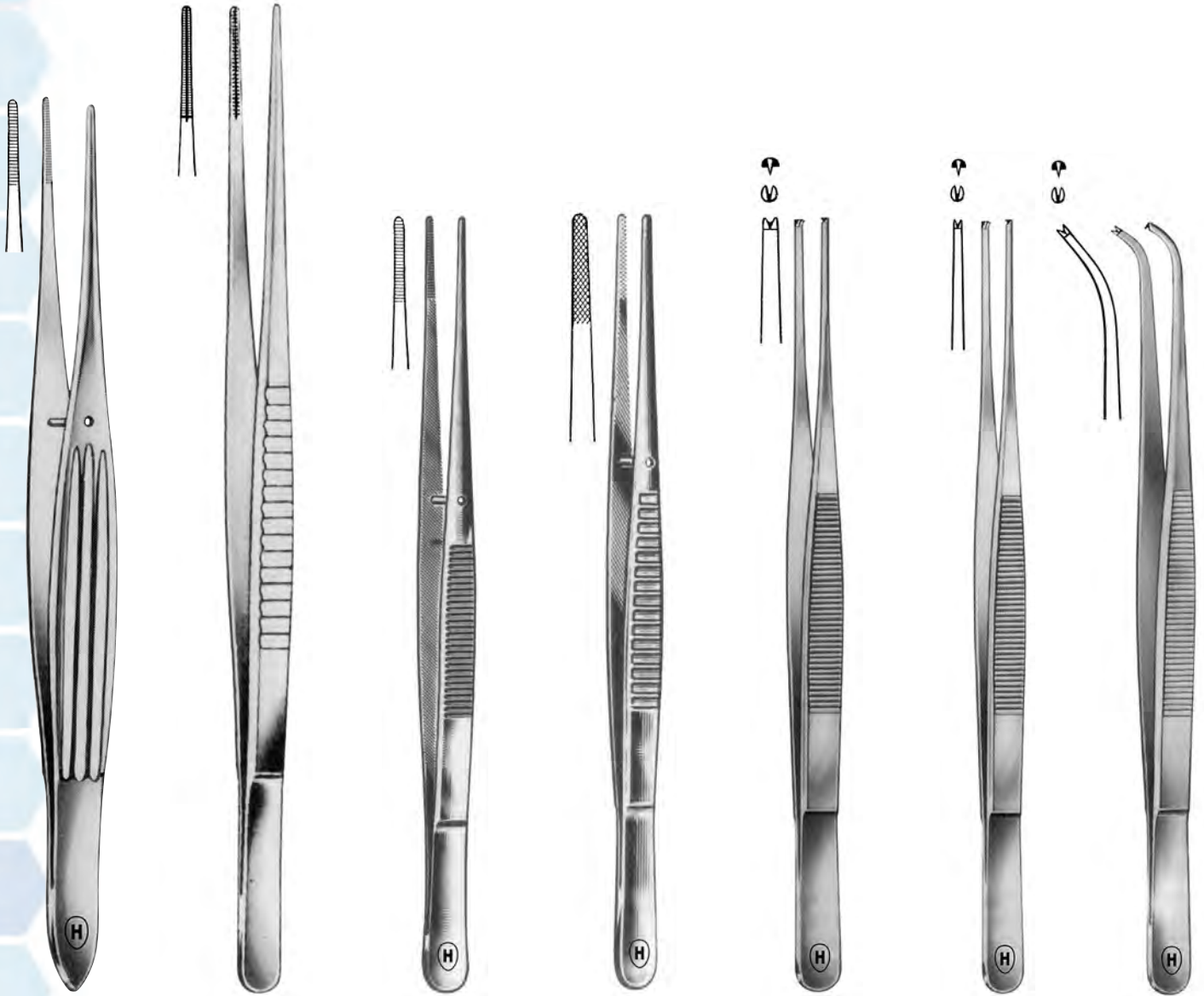
Pinzetten  
Forceps**HSC 090-15  
Mc Indoe**

Feine anatomische Pinzetten,  
gerade  
Delicate dressing forceps,  
straight

CE

**HSC 100-15  
De Bakey**

150 / 1,5 mm  
Atraumatische Pinzetten,  
gerade  
Atraumatic forceps,  
straight

CE

**HSC 126-18  
Taylor**

180 mm  
Anatomische Pinzetten, fein  
Dressing forceps, delicate

CE

**HSC 128-15  
Waugh**

150 mm

CE

**HSC 129-20  
Waugh**

200 mm  
Anatomische Pinzetten, fein  
Dressing forceps, delicate

CE

**HSC 202-13  
Standard**

130 mm

CE

**HSC 204-14  
Standard**

145 mm

CE

**HSC 206-16  
Standard**

160 mm

Chirurgische Pinzetten,  
gerade  
Tissue forceps, straight

**HSC 214-13**

130 mm

CE

**HSC 216-14**

145 mm

Chirurgische Pinzetten,  
gerade, schlankes Modell  
Tissue forceps, straight,  
delicate model

CE

**HSC 215-13**

130 mm

CE

**HSC 217-14**

145 mm

gebogen,  
schlankes Modell  
curved,  
delicate model

CE

Pinzetten  
Forceps



**HSC 230-12  
Adson**  
120 mm  
Feine Pinzetten  
Delicate forceps  
CE



**HSC 231-15  
Adson**  
150 mm  
Feine Pinzetten  
Delicate forceps  
CE



**HSC 232-12  
Micro-Adson**  
120 mm  
Feine Pinzetten  
Delicate forceps  
CE



**HSC 233-15  
Micro-Adson**  
150 mm  
Feine Pinzetten  
Delicate forceps  
CE



**HSC 238-12  
Semken**  
120 mm  
Feine chirurgische Pinzetten, gerade  
Delicate tissue forceps, straight  
CE



**HSC 239-12  
Semken**  
120 mm  
Feine chirurgische Pinzetten, gebogen  
Delicate tissue forceps, curved  
CE



**HSC 234-12  
Adson-Brown**  
120 mm  
Feine Pinzetten, gerade  
Delicate forceps, straight  
CE



**HSC 235-12  
Adson-Brown**  
120 mm  
Feine Pinzetten, gebogen  
Delicate forceps, curved  
CE

Alle mit CE gekennzeichneten Produkte sind Medizinprodukte. | All products marked with CE are medical devices.

Pinzetten  
Forceps

**HSC 250-17**  
175 mm / 7 inch  
**Gerald**  
Mikro-Pinzette, anatomisch, gerade  
Micro dressing forceps, straight  
CE



**HSC 251-17**  
175 mm / 7 inch  
**Gerald**  
Mikro-Pinzette, anatomisch, gebogen  
Micro dressing forceps, curved  
CE



**HSC 243-15**  
**Gillies**  
150 mm  
Feine chirurgische Pinzetten  
Delicate tissue forceps  
CE



**HSC 252-17**  
175 mm / 7 inch  
**Gerald**  
Mikro-Pinzette, chirurgisch, gerade  
Micro tissue forceps, straight  
CE



**HSC 244-18**  
**Taylor**  
180 mm  
Feine chirurgische Pinzetten  
Delicate tissue forceps  
CE



**HSC 253-17**  
175 mm / 7 inch  
**Gerald**  
Mikro-Pinzette, chirurgisch, gebogen  
Micro tissue forceps, curved  
CE





Zahnfleischmesser und Skalpelle  
Gum knives and Scalpels



**HWB 201-26**  
120 - 125 mm  
CE



**HWB 202-20**  
20 mm  
CE



**HWB 203-23**  
23 mm  
CE



**HWB 204-25**  
25 mm  
CE



**HWB 205-20**  
20 mm  
CE

Zahnfleischmesser, sehr fein  
Gum knives, very delicate



**HWB 220-30**  
30 mm  
155 - 160 mm  
CE



**HWB 222-40**  
40 mm  
CE



**HWB 224-35**  
35 mm  
CE

Skalpelle  
Scalpels

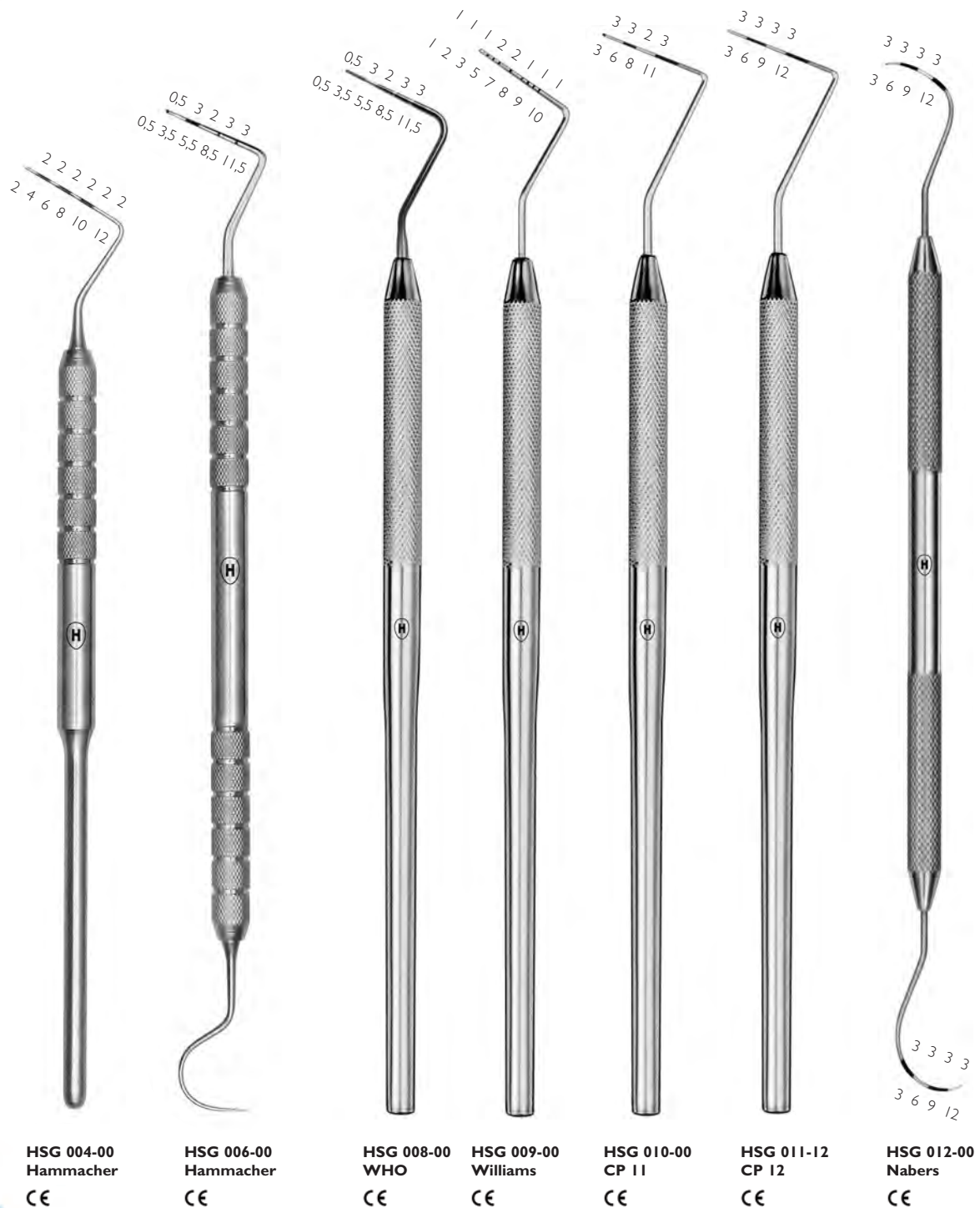
**Taschenmesssonden**  
**Calibrated probes**

**HSG 004-00**  
**Hammacher**  
**CE**
**HSG 006-00**  
**Hammacher**  
**CE**
**HSG 008-00**  
**WHO**  
**CE**
**HSG 009-00**  
**Williams**  
**CE**
**HSG 010-00**  
**CP 11**  
**CE**
**HSG 011-12**  
**CP 12**  
**CE**
**HSG 012-00**  
**Nabers**  
**CE**

Taschenmesssonden, Tunnelierinstrumente + Gingiva-Abhalter  
Calibrated probes, tunnelling instruments + gingiva retractor

Die Tunnelierinstrumente dienen zur Präparation von Spalt- und Vollflappen für einen späteren Kammaufbau sowie zum Aufbau der Gingiva bei Rezessionen. Die fein gearbeiteten Arbeitsenden erlauben eine präzise Öffnung der Gingiva und somit werden große Aufklappungen vermieden.

The tunnelling instruments are designed for the preparation of split and full thickness flaps for a subsequent ridge augmentation and for repairs of gingival defects caused by receding gums. The accurately manufactured working ends allow a precise opening of the gingiva and thus large flap openings are avoided.

1-2-3-4-5-6-7-8-9-10



HSG 014-00

Präparations-  
Tiefenmesssonde nach  
Dr. Göbel / Dr. Gruner

- sicheres Messen des bestimmten, erforderlichen Zahnabtrages bei Keramikpräparationen

Preparation depths  
measuring probe according  
to Dr. Göbel / Dr. Gruner

- reliable measurement of tooth wear certain necessary preparations for ceramics

CE



HSG 016-00  
WHO

Taschenmesssonde mit 90°  
Winkelung und Doppelbiegung  
Calibrated probe with 90°  
angulation and double bend

CE

HSG 017-36  
Michigan (3-6-8)

Taschenmesssonde  
Calibrated probe



HSG 258-01

CE



HSG 259-02

CE



HSF 106-02  
nach Prof. Dr. Günay  
fig. 2

Gingiva-Abhalter, doppelendig  
Gingiva retractor, double ended

CE

Alle mit CE gekennzeichneten Produkte sind Medizinprodukte. | All products marked with CE are medical devices.

**Abziehsteine, Schleiföl + Mikro-Raspatorien  
Sharpening stones, sharpening oil + micro raspatories**

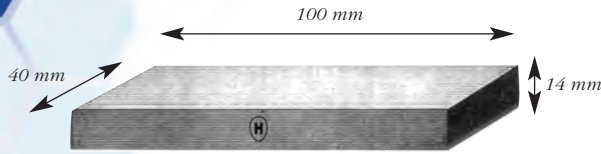

**HSG 291-00**  
Abziehsteine Arkansas  
Arkansas sharpening stones



**HSG 297-00**  
125 ml  
Schleiföl  
Sharpening oil



**HSF 108-00**  
nach Prof. Dr. Günay  
Gingiva-/Mukosa-Abhalter  
Gingiva / mucosa retractor



**HWK 012-00**  
nach Prof. Dr. Günay  
165 mm  
stumpf  
blunt  
CE

**HWK 013-00**  
nach Prof. Dr. Günay  
165 mm  
spitz  
sharp  
CE

**HWK 023-00**  
nach Prof. Dr. Günay  
170 mm  
CE  
Kürette, doppelendig  
Curette, double ended

Mikro-Raspatorium, doppelendig  
Micro raspatory, double ended

Die Anwendungsbereiche des modifizierten Gingiva- /Mukosa-Abhalters sind vielfältig – besonders in der Parodontologie und Periimplantologie bei der „Nicht Chirurgische Parodontitis / Periimplantitis Therapie“ (NCPT). Speziell in der minimalinvasiven parodontalen Regeneration (evtl. auch in der regenerativen periimplantitis Therapie) ohne Lappenbildung braucht man spezielle Instrumente für das Abhalten des Zahnfleisches und betrachten der Wurzel- bzw. Implantatoberfläche sowie für die Applikation des Medikaments/Gels.

The areas of application of the modified gingiva / mucosa retractor are diverse - especially in periodontology and peri-implantology for "Non-surgical periodontitis / peri-implantitis therapy" (NCPT). Especially in the minimally invasive periodontal regeneration (possibly also in the regenerative peri-implantitis therapy) without flap formation, special instruments are required to hold the gums and view the root or implant surface as well as for the application of the medicament / gel.

**ImPlan** – die neue Serie Scaler für die Implantologie, mit denen Sie sicher mit Implantaten arbeiten können, weil sie aus dem gleichen Material gefertigt sind – massivem Titan. Sie verkratzen die Implantate nicht und verursachen keinen Schaden daran.

**ImPlan** – the new series of scalers for implantology which work safely with implants because they are made from the same material – solid titanium. They do not scratch the implants and do not cause any rejections.

**Zahnreiniger + Küretten  
Scalers + cures**



**HTG 115-67**  
Sickle 6-7  
CE

**HTG 116-204**  
Posterior Sickle 204S  
CE

**HTG 117-56**  
Universal Curette /  
Barnhart 5-6  
CE

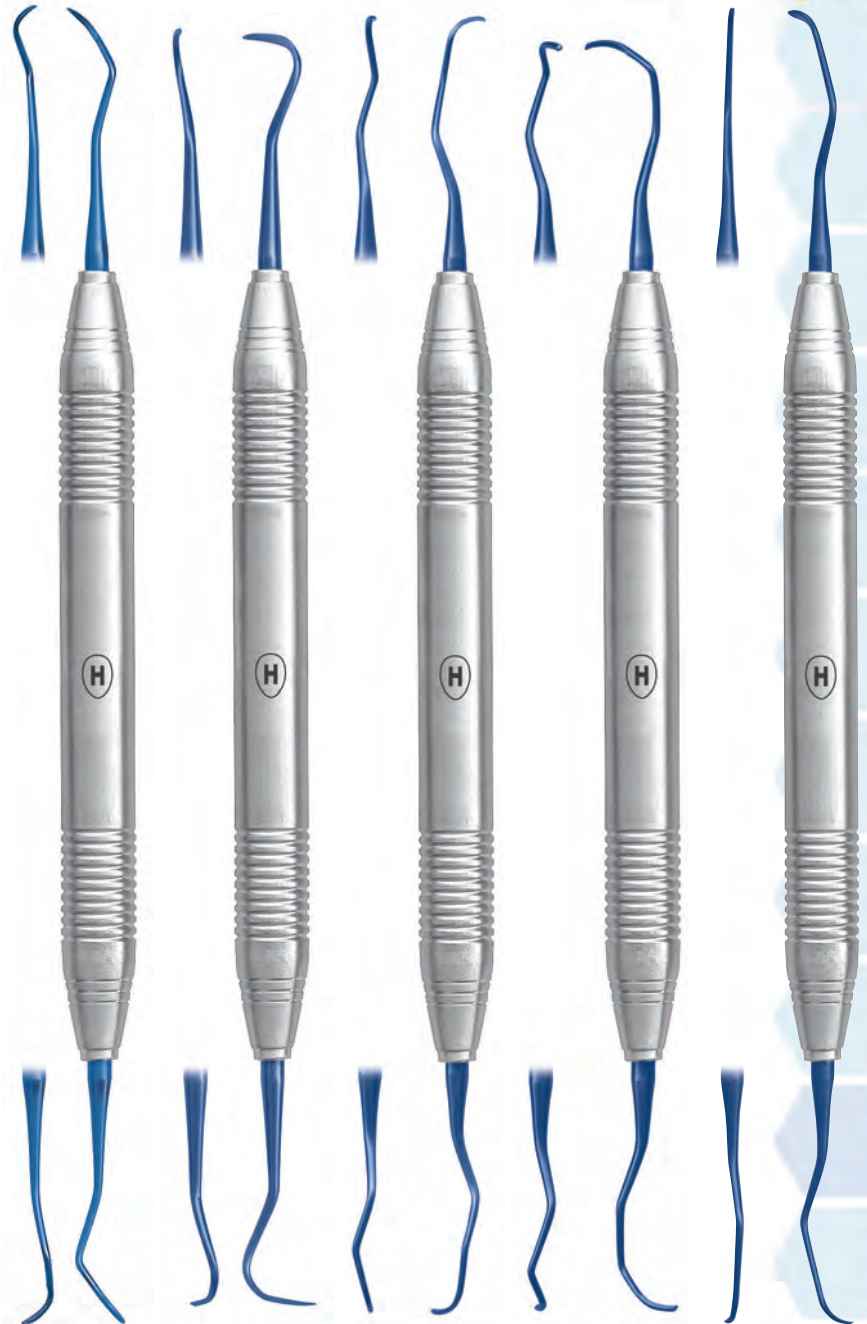

**HTG 064-20**  
Fig. 204SD  
Universal Scaler  
CE

**HTG 065-67**  
Fig. H6/H7  
Universal Scaler  
CE

**HTG 066-12**  
Langer Fig. 1-2  
Kürette / Curette  
CE

**HTG 067-34**  
Langer Fig. 3-4  
Kürette / Curette  
CE

**HTG 068-56**  
Langer Fig. 5-6  
Kürette / Curette  
CE

**Reiniger / Küretten mit Arbeitenden aus TITAN mit sehr leichtem Griff**

- ✓ ideal für die Reinigung von Implantaten
- ✓ durch die Verwendung von Titan für die Spitzen wird eine Beschädigung der Implantatoberflächen vermieden

**Scalers / cures with working ends made of TITANIUM with a very light handle**

- ✓ ideal for the cleaning of implants
- ✓ by using titanium for the tips a damage to the implant surfaces will be prevented

Zahnreineriger  
Scalers

**HSG 203-00**  
*(U15/U30)*  
Towner

 2, 4, 6, 7, 8

supragingival  
supragingival

CE



**HSG 050-00**  
Cumine  
CE



**HSG 051-00**  
Osteo Trimmer  
Mitchel  
CE



**HSG 075-01**  
Abott  
CE



**HSG 076-02**  
*fig. 2*  
Abott  
CE



**HSG 077-03**  
*fig. 3*  
Abott  
CE



**HSG 078-04**  
*fig. 4*  
Abott  
CE



**HSG 339-53**  
*Fig. H5-33*

Sichelscaler  
Sickle scaler

CE

Alle mit CE gekennzeichneten Produkte sind Medizinprodukte. | All products marked with CE are medical devices.

Zahnreiner + Provisorienabnehmer  
Scalers + provisional prosthesis lifters

Wironit



**HSR 100-00**

Zahnreiner  
Scaler

Handinstrumente mit  
PPSU-Griff, sterilisierbar  
Hand instruments with  
PPSU handle, sterilizable  
CE



**HWG 086-00  
Hammacher**

Zahnreiner  
Scalers  
CE



**HWG 100-00  
CE**



**HWG 101-00  
Hammacher  
CE**

Provisorienabnehmer  
Provisional prosthesis lifter



**HWG 102-00  
Black  
CE**



**HSK 250-175  
Rhodes  
175 mm**

Meißel, Back Action  
Chisels, Back Action  
CE

## Parodontalfeilen

zum Bearbeiten von Furkationen – Arbeitsenden für die Feilbewegung auf beiden Seiten gezackt

## Periodontal files

used interproximally – file surface on both sides allowing a push and pull application

## Parodontalfeilen Periodontal files



**HSG 240-37**  
fig. 3/7  
Hirschfeld

**HSG 241-51**  
fig. 5/11  
Hirschfeld

**HSG 285-10**  
fig. 9/10  
Schluger

**HSG 286-01**  
fig. 1S/2S  
Sugarman

**HSG 287-01**  
Fig. CEDF1

**HSG 288-34**  
Sugarman  
Fig. 3S-4S

**HSG 289-11**  
Buck  
Fig. 11-12

Feile zur Wurzelglättung  
CE

gebogen / curved  
CE

Mesial / Distal  
CE

Furkationsfeile, diamantiert  
Furcation files, diamond coated  
CE

Parodontalfeilen  
Perio files  
CE

Parodontalfeilen  
Perio files  
CE

Alle mit CE gekennzeichneten Produkte sind Medizinprodukte. | All products marked with CE are medical devices.





**Zahnreiniger + Universalküretten** - Dicke des Griffes Ø 10mm  
**Scalers + universal curettes** - Thickness of the handle Ø 10mm



**HSG 330-67**  
Fig. N67

Beide Sichel­n haben eine identische mittlere Größe, eine mittlere Länge und eine Klingenbreite von 0,9 mm, die spitz zuläuft. Die Spitzen haben eine 10° Spiegelbildversetzung, um einen besseren Zugang zu Frontzähnen und Prämolaren zu ermöglichen. Dieses Design ist auch als H6/H7 bekannt.

Both sickles have an identical moderate size, medium-reach length and a blade width of 0,9 mm that taper to a point. The tips have a 10° mirror image offset to allow a better access to anteriors and premolars. This design is also known as H6/H7.

CE

**HSG 331-04**  
Fig. 204S

Spiegelbildklingen auf einem Schaft mit kurzer Reichweite, der mit 40° zum Griff befestigt ist. Die Klingen haben eine Reichweite von 4,5 mm und eine Breite von 0,9 mm.

Mirror image blades on a short-reach terminal shank that is set at 40° to the handle. The blades have a reach of 4,5 mm and a width of 0,9 mm.

CE

**HSG 337-04**  
Fig. 204SD

Spiegelbildklingen auf einem Schaft mit kurzer Reichweite, der mit 25° zum Griff befestigt ist. Die Klingen haben eine Reichweite von 4,5 mm und eine Breite von 0,9 mm.

Mirror image blades on a short-reach terminal shank that is set at 25° to the handle. The blades have a reach of 4,5 mm and a width of 0,9 mm.

CE

**HSG 340-02**  
Fig. 2R/2L  
Columbia

Der Schaft hat einen Durchmesser von 1,2 mm und ist 14 mm lang mit einer langen elliptischen geformten Klinge, die 1,2 mm breit ist.

The terminal shank is 1,2 mm in diameter and 14 mm long with an long elliptical blade shape that is 1,2 mm wide.

CE

**HSG 341-04**  
Fig. 4R/4L  
Columbia

Der Schaft hat einen Durchmesser von 1,1 mm und ist 12 mm lang mit einer langen elliptischen geformten Klinge, die 1,2 mm breit ist.

The terminal shank is 1,1 mm in diameter and 12 mm long with an long elliptical blade shape that is 1,2 mm wide.

CE

**HSG 345-14**  
Fig. 13S/14S  
McCall

Der Schaft hat einen Durchmesser von 1,1 mm und ist 9 mm lang mit einer spitz geformten Klinge, die 1 mm breit ist.

The terminal shank is 1,1 mm in diameter and 9 mm long with a pointed blade shape that is 1 mm wide.

CE

**HSG 347-18**  
Fig. 17S/18S  
McCall

Die Schaftkrümmung passt sich mühelos den zweiten und dritten Molaren an. Die Universalklinge mit geraden Seiten hat eine abgerundete Spitze und ist 1 mm breit.

The shank curvature adapts easily to the 2nd and 3rd molars. The straight-sided universal blade has a rounded toe and is 1 mm wide.

CE

Alle mit CE gekennzeichneten Produkte sind Medizinprodukte. | All products marked with CE are medical devices.

**Zahnreiniger- Dicke des Griffs Ø 10mm**  
**Scalers - Thickness of the handle Ø 10mm**



**HSG 375-00  
ALSR**

Dieses Instrument erleichtert die Entfernung von Verfärbungen im lingualen und palatinalen Frontzahnbereich. Es besteht zum einen aus einer Vorderzahn-Haue und einem löffelförmigen Anterior-Scaler im Kontra-Winkel. Mit der Haue werden Verfärbungen im anterior-lingualen Bereich beseitigt. Mit dem Löffel kann man den Sulkus bei der Reinigung der Zahnfläche am Zahnfleischrand zurückschieben. Dieser Scaler hat den Vorteil, dass er sich einfach an die Wölbungen und Rillen des palatinalen Frontzahnbereiches anpasst.

This instrument facilitates the removal of discolorations of the lingual and palatal anterior teeth. It consists of a front tooth pick and a spoon-shaped anterior scaler at a contra-angle. With the pick, discoloration in the anterior-lingual area is eliminated. With the spoon you can push back the sulcus when cleaning the tooth surface at the gumline. The advantage of this scaler is that it easily adapts to the bulges and grooves of the palatal anterior region.



**HSG 376-04  
CESC204**

Spiegelbildklingen an einem langen Schaft, der mit 30° zum Griff befestigt ist. Die Klingen haben eine Reichweite von 5,5 mm und eine Breite von 1,1 mm.

Mirror image blades on a long-reach terminal shank that is set at 30° to the handle. The blades have a reach of 5.5 mm and a width of 1.1 mm.



**HSG 377-04  
CESC204S**

Spiegelbildklingen an einem kurzen Schaft, der mit 40° zum Griff befestigt ist. Die Klingen haben eine Reichweite von 4,5 mm und eine Breite von 0,9 mm.

Mirror image blades on a short-reach terminal shank that is set at 40° to the handle. The blades have a reach of 4.5 mm and a width of 0.9 mm.



**HSG 378-04  
CESC204SD**

Spiegelbildklingen an einem kurzen Schaft, der mit 25° zum Griff befestigt ist. Die Klingen haben eine Reichweite von 4,5 mm und eine Breite von 0,9 mm.

Mirror image blades on a short-reach terminal shank that is set at 25° to the handle. The blades have a reach of 4.5 mm and a width of 0.9 mm.



**HSG 379-13  
CESCNI37M**

**Scalette, Anterior, NI37 kurzes Arbeitsende** – ein Prophylaxe-Instrument, das die Charakteristika von Scalern und Küretten in einem Instrument kombiniert. Durch den Gebrauch der Scalette spart man Zeit bei der Behandlung, Platz auf dem Behandlungstisch und reduziert die Kosten bei der Neuanschaffung von Instrumenten. Das Instrument kombiniert den sehr beliebten Sichel-Scaler mit einer Universalkürette (anterior). Mit diesem Instrument können Sie alle Flächen im Frontzahnbereich bearbeiten. Somit sparen Sie Zeit, Platz und reduzieren die Wiederbeschaffungskosten.

**Scalette, Anterior, NI37 with a short working end** – a prophylaxis instrument that combines the characteristics of scalers and curettes in one instrument. Using the Scalette saves time during the treatment, space on the treatment table and reduces the cost when buying new instruments. The instrument combines the very popular sickle scaler with a universal curette (anterior). With this instrument you can work on all surfaces in the anterior region. This saves you time, space and reduces replacement costs.

**Zahnreiniger- Dicke des Griffs Ø 10mm**  
**Scalers - Thickness of the handle Ø 10mm**



**HSG 380-13**  
**CESCNI37ML**

**Scalette, Anterior, N137 kurzes Arbeitsende mit einem langen Schaft** – ein Prophylaxe-Instrument, das die Charakteristika von Scalern und Küretten in einem Instrument kombiniert. Durch den Gebrauch der Scalette spart man Zeit bei der Behandlung, Platz auf dem Behandlungstisch und reduziert die Kosten bei der Neuanschaffung von Instrumenten. Das Instrument kombiniert den sehr beliebten Sichel-Scaler mit einer Universalkürette (anterior). Mit diesem Instrument können Sie alle Flächen im Frontzahnbereich bearbeiten. Somit sparen Sie Zeit, Platz und reduzieren die Wiederbeschaffungskosten.

**Scalette, Anterior, N137 with a short working end with a long shaft** – a prophylaxis instrument that combines the characteristics of scalers and curettes in one instrument. Using the Scalette saves time during the treatment, space on the treatment table and reduces the cost when buying new instruments. The instrument combines the very popular sickle scaler with a universal curette (anterior). With this instrument you can work on all surfaces in the anterior region. This saves you time, space and reduces replacement costs.



**HSG 381-15**  
**CESCNI35**

Kombiniert einen langen Schaft und eine dünne Kürettenklinge, die wie ein Scaler spitz zuläuft, um eine einfache Anpassung an supra- und subgingivale Bereiche sowie einen hervorragenden interproximalen Zugang zu ermöglichen. Die spiegelbildlichen Spitzen haben eine Klingebreite von 0,8 mm, die auf 1 mm Schäften mit einer Reichweite von 12 mm befestigt sind.

Combines a long-reach shank and a thin curette blade that is pointed like a scaler to provide easy adaptation to both supra and sub-gingival areas and excellent interproximal access. The mirror image tips have a 0.8 mm blade width set on 1 mm terminal shanks with a 12 mm reach.



**HSG 382-13**  
**CESCO13-14**

**Columbia #13-14** Der Schaft hat einen Durchmesser von 1 mm und eine Länge von 8 mm bei einer Klingebreite von 0,9 mm.

**Columbia #13-14** The terminal shank is 1 mm in diameter and 8 mm long with a blade width of 0.9 mm.



**HSG 383-56**  
**CESCBH5-6**

**Barnhart #5-6** Der Schaft hat einen Durchmesser von 1 mm und eine Länge von 10 mm bei einer Klingebreite von 0,8 mm.

**Barnhart #5-6** The terminal shank is 1 mm in diameter and 10 mm long with a blade width of 0.8 mm.

**Gracey-Küretten, einseitig schneidend - Dicke des Griffs Ø 8mm**  
**Gracey curettes, sharp on one side only - Thickness of the handle Ø 8mm**



Anterior  
fig. 1/2



Posterior  
fig. 7/8



Posterior  
fig. 11/12



Posterior  
fig. 13/14



Posterior  
fig. 15/16



Location of cutting  
edges of  
fig. 13/14 + 15/16



**HSG 210-12**  
fig. 1/2  
**Gracey**  
CE



**HSG 211-34**  
fig. 3/4  
**Gracey**  
CE



**HSG 212-56**  
fig. 5/6  
**Gracey**  
CE



**HSG 213-78**  
fig. 7/8  
**Gracey**  
lingual  
buccal  
CE



**HSG 214-91**  
fig. 9/10  
**Gracey**  
CE



**HSG 215-11**  
fig. 11/12  
**Gracey**  
mesiolingual  
mesiobuccal  
CE



**HSG 216-13**  
fig. 13/14  
**Gracey**  
distal  
CE



**HSG 217-15**  
fig. 15/16  
**Gracey**  
mesial  
CE

Alle mit CE gekennzeichneten Produkte sind Medizinprodukte. | All products marked with CE are medical devices.



**Gracey Küretten  
Gracey curettes**

**HSG 360-12 – HSG 368-17 werden mit einem speziellen Griff geliefert** - aus electropoliertem Edelstahl mit einem matteden Mittelteil und zwei Steckplätzen für Farbcodieringsringe am Ende des Griffes – **Durchmesser 10 mm, Gewicht 18 g**

**HSG 360-12 – HSG 368-17 will be delivered with a special handle** - from electro-polished stainless steel with a satin finish centre portion and two intended slots for colour coding rings near the end – **diameter 10 mm, weight 18 g**

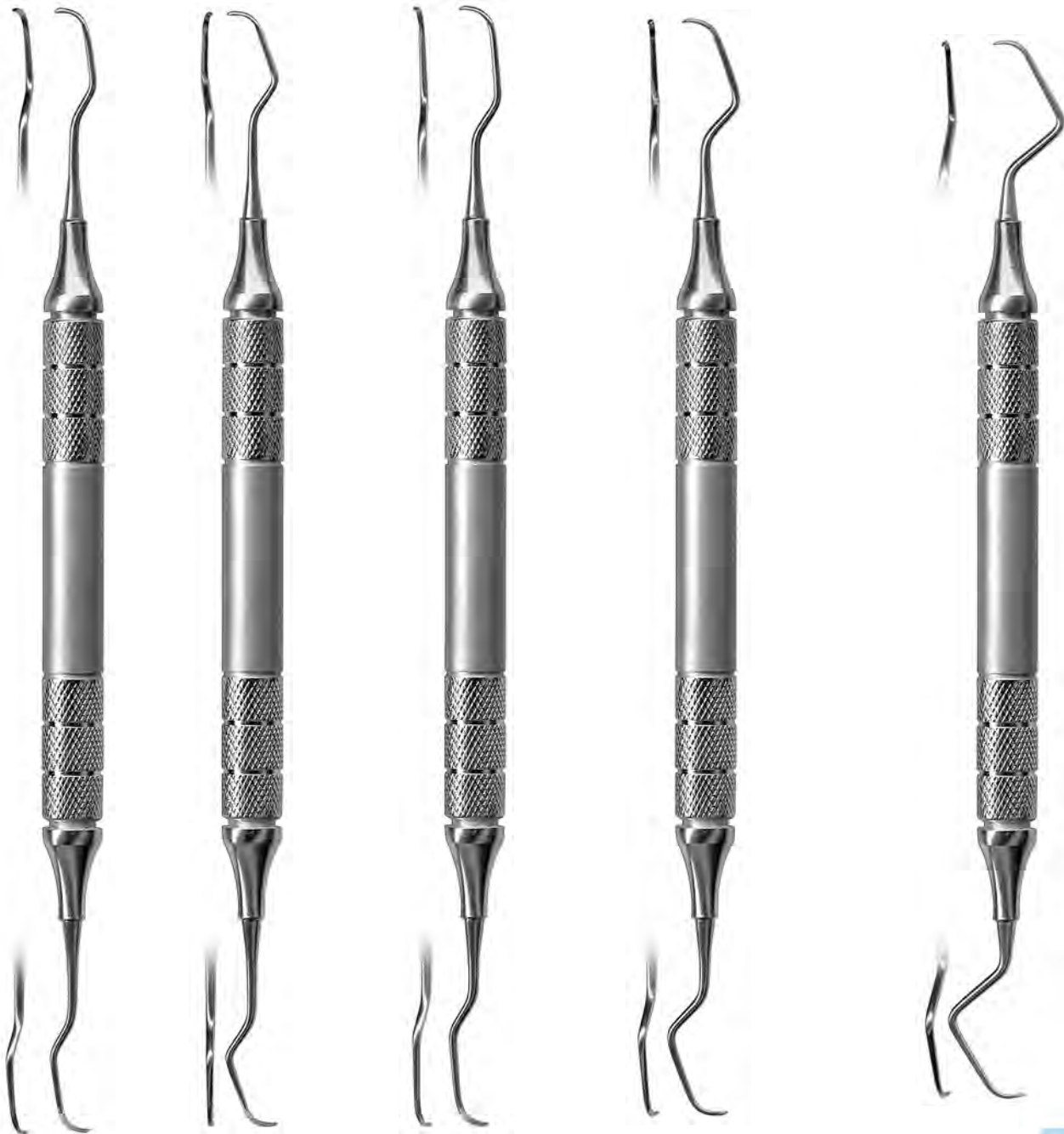

**HSG 360-12**

*Fig. 1/2*

**Gracey**

kurzes Winkelstück für Schneide- und Eckzähne  
short contra-angle for incisors and cuspids

CE

**HSG 361-34**

*Fig. 3/4*

**Gracey**

Medium Schaft und geringer Winkel  
für Prämolaren und Molaren  
medium shank and slight contra-angle  
for bicuspid and molars

CE

**HSG 362-56**

*Fig. 5/6*

**Gracey**

Mittleres Winkelstück für faciale und linguale  
Flächen für Prämolaren und Molaren  
medium contra-angle for facial and lingual  
surfaces for bicuspid and molars

CE

**HSG 363-78**

*Fig. 7/8*

**Gracey**

langes Winkelstück für Molaren und  
schwerer zugängliche Wurzeloberflächen  
long contra-angle for molars and less  
accessible root surfaces

CE

**HSG 364-91**

*Fig. 9/10*

**Gracey**

sehr langes Winkelstück für Molaren und  
sehr schwer zugängliche Wurzeloberflächen  
very long contra-angle for molars and very  
less accessible root surfaces

CE

## Gracey Küretten Gracey curettes



**HSG 360-12 – HSG 368-17 werden mit einem speziellen Griff geliefert** - aus electropoliertem Edelstahl mit einem matteden Mittelteil und zwei Steckplätzen für Farbcodierungsringe am Ende des Griffes – **Durchmesser 10 mm, Gewicht 18 g**

**HSG 360-12 – HSG 368-17 will be delivered with a special handle** - from electro-polished stainless steel with a satin finish centre portion and two intended slots for colour coding rings near the end – **diameter 10 mm, weight 18 g**



**HSG 365-11**

Fig. 11/12

**Gracey**

alle mesialen Flächen von  
Prämolaren und Molaren  
all mesial surfaces of bicusps  
and molars

CE



**HSG 366-13**

Fig. 13/14

**Gracey**

alle distalen Flächen von  
Prämolaren und Molaren  
all distal surfaces of bicusps  
and molars

CE



**HSG 367-15**

Fig. 15/16

**Gracey**

modifizierte Version von Fig. 11/12, die einen besseren  
Zugang und eine komfortablere Hand- und  
Fingerposition für alle mesialen Flächen von  
Prämolaren und Molaren ermöglicht

modified version of Fig. 11/12 which allows a better  
access and a more comfortable hand and finger  
position for all mesial surfaces of  
bicusps and molars

Alle mit CE gekennzeichneten Produkte sind Medizinprodukte. | All products marked with CE are medical devices.



**HSG 368-17**

Fig. 17/18

**Gracey**

modifizierte Version von Fig. 13/14, die einen  
besseren Zugang und eine komfortablere Hand- und  
Fingerposition für alle distalen Flächen von  
Prämolaren und Molaren ermöglicht

modified version of Fig. 13/14 which allows a better  
access and a more comfortable hand and finger  
position for all distal surfaces of  
bicusps and molars



Farbringe  
Colour rings

Sterilisierbar bis max. 177°C  
Sterilizable up to max. 177°C



Farbringe - in 14 verschiedenen Farben  
in Paketen von 48 Ringen in einer Farbe

Colour rings - in 14 different colours  
available in single colour packages of 48 rings



p.115-116



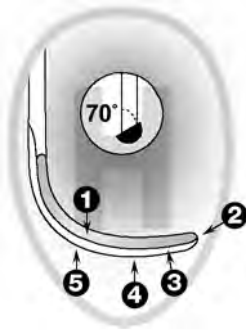

**Winkel zwischen Schaft und Fazialfläche einer Gracey Kürette**  
**Angle between shank and facial area of a Gracey curette**

- |                             |                      |                               |                              |                           |
|-----------------------------|----------------------|-------------------------------|------------------------------|---------------------------|
| <b>1</b>                    | <b>2</b>             | <b>3</b>                      | <b>4</b>                     | <b>5</b>                  |
| Fazialfläche<br>Facial area | Rundung<br>Roundness | Schneidekante<br>Cutting edge | Lateralfäche<br>Lateral area | Rückenfläche<br>Back area |

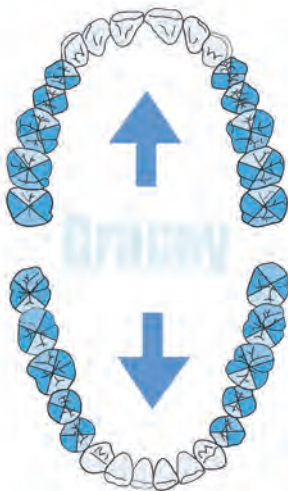

- #1-2 / #3-4 / #5-6
- #7-8 / #9-10
- #11/12 / #5-16
- #13-14 / #17-18

Die **Gracey-Küretten** verfügen über eine Blattflächenkurve mit einem echten Radius, der sich besser als jede andere Marke an die Zahnanatomie anpasst. Dies bedeutet, dass diese Gracey-Küretten einfacher anzupassen sind, weniger Striche erfordern und das Gewebetrauma besser reduzieren als jede andere Marke. Diese Gracey-Küretten haben einen Schaftdurchmesser von 1,1 mm und Klingen mit einer Breite von 0,9 mm und einer Länge von 4 mm.

**Dicke des Griffs Ø 10mm**

**Mini-Long** Der Schaft ist 3 mm länger als der bei Standard-Gracey mit einer kürzeren und schmaleren „Mini“-Klinge. Hervorragend geeignet für die parodontale Pflege in tiefen Taschen.

The **Gracey curettes** feature a blade face curve with a true radius that conforms to tooth anatomy better than any other brand. This means that these Gracey curettes are easier to adapt, require fewer strokes, and reduce tissue trauma better than any other brand. These Gracey curettes have a 1.1 mm terminal shank diameter and blades that are 0.9 mm wide and 4 mm long.  
**Thickness of the handle Ø 10mm**

**Mini-Long** The terminal shank is 3 mm longer than the standard Gracey with a shorter and narrower “mini” blade. Excellent for periodontal maintenance in deep pockets.



Für Frontzahnbereich  
Anterior  
fig. 1/2



Für den molaren und prämolaren Bereich, oral und fazial  
Posterior  
fig. 7/8



Für den mesialen Bereich  
Posterior  
fig. 11/12



Für den distalen Bereich  
Posterior  
fig. 13/14



Für den mesialen Bereich  
Posterior  
fig. 15/16



Schneidekanten bei fig. 13/14 und fig. 15/16  
Cutting edges of fig. 13/14 and fig. 15/16



**Küretten - Dicke des Griiffs Ø 10mm  
Curettes - Thickness of the handle Ø 10mm**



**HSG 385-78  
CESCYG7-8**

Younger-Good #7-8 Die Schaftkrümmung passt sich leicht dem 2. und 3. Molar an. Die elliptische Klingenform hat eine abgerundete Spitze und ist 1 mm breit.

Younger-Good #7-8 The shank curvature adapts easily to 2nd and 3rd molars. The elliptical blade shape has a rounded toe and is 1 mm wide.



**HSG 350-12  
CESCGRI-2ML**

Gracey #1-2 Kurzer Kontrawinkel für Schneide- und Eckzähne. Die Reichweite des Schafts beträgt 11 mm.

Gracey #1-2 Short contra-angle for incisors and cuspids. Terminal shank reach is 11 mm.



**HSG 351-34  
CESCGR3-4ML**

Gracey #3-4 Kurzer Kontrawinkel für Schneide- und Eckzähne. Die Reichweite des Schafts beträgt 11 mm.

Gracey #3-4 Short contra-angle for incisors and cuspids. Terminal shank reach is 11 mm.



**HSG 352-56  
CESCGR5-6ML**

Gracey #5-6 Mittlerer Schaft und leichter Kontrawinkel für vordere Backenzähne und Molaren. Die Reichweite des Schafts beträgt 14 mm.

Gracey #5-6 Medium shank and slight contra-angle for bicusps and molars. Terminal shank reach is 14 mm.



**HSG 353-78  
CESCGR7-8ML**

Gracey #7-8 Mittlerer Kontrawinkel für Gesichts- und Lingualflächen von vorderen Backenzähnen und Molaren. Die Reichweite des Schafts beträgt 12 mm.

Gracey #7-8 Medium contra-angle for facial and lingual surfaces of bicusps and molars. Terminal shank reach is 12 mm.

## Küretten Curettes



**HSG 354-91  
CESGR9-10ML**

Gracey #9-10 Langer Kontrawinkel für Backenzähne und weniger zugängliche Wurzeloberflächen. Die Reichweite des Schafts beträgt 12 mm.

Gracey #9-10 Long contra-angle for molars and less accessible root surfaces. Terminal shank reach is 12 mm.



**HSG 355-11  
CESGR11-12ML**

Gracey #11-12 Alle mesialen Oberflächen der vorderen Backenzähne und Molaren. Die Reichweite des Schafts beträgt 8 mm.

Gracey #11-12 All mesial surfaces of bicuspid and molars. Terminal shank reach is 8 mm.



**HSG 356-13  
CESGR13-14ML**

Gracey #13-14 Alle distalen Oberflächen der vorderen Backenzähne und Molaren. Die Reichweite des Schafts beträgt 9 mm.

Gracey #13-14 All distal surfaces of bicuspid and molars. Terminal shank reach is 9 mm.



**HSG 357-15  
CESGR15-16ML**

Gracey #15-16 Die modifizierte Version des Gracey 11-12 ermöglicht einen besseren Zugang und eine bequemere Hand- und Fingerposition für alle mesialen Oberflächen der vorderen Backenzähne und Molaren. Die Reichweite des Schafts beträgt 9 mm.

Gracey #15-16 Modified version of the Gracey 11-12 allows better access and a more comfortable hand and finger position for all mesial surfaces of bicuspid and molars. The terminal shank reach is 9 mm.



**HSG 358-17  
CESGR17-18ML**

Gracey #17-18 Die modifizierte Version des Gracey 13-14 ermöglicht einen besseren Zugang und eine bequemere Hand- und Fingerposition für alle distalen Oberflächen der vorderen Backenzähne und Molaren. Die Reichweite des Schafts beträgt 7 mm.

Gracey #17-18 Modified version of the Gracey 13-14 allows better access and a more comfortable hand and finger position for all distal surfaces of bicuspid and molars. The terminal shank reach is 7 mm.

**Endodontie Instrumente  
Endodontics Instruments**



**HWJ 031-00**  
Endodontie-Sonde  
Endodontic explorer  
CE

**HWJ 032-16**  
Endodontie-Sonde  
Endodontic explorer  
CE



**HSG 029-01**  
**GLICK 1**

Wurzelkanalstopfer zum Komprimieren des Füllmaterials während der vertikalen Kondensation  
Root canal plugger used to compact filling material during vertical condensation

CE



**HSG 029-02**  
**GLICK 2**

Endo-Exkavator für den einfachen Zugriff und die Entfernung von Dentin  
Endo excavator is a popular instrument for easy access and removal of dentin

CE



**HSG 024-31**  
No. 31 L  
CE



**HSG 024-32**  
No. 32 L  
CE

Endo-Exkavator; doppelendig, mit Rundgriff  
Endo excavator; double ended, with round handle



**HSG 024-33**  
No. 33 L  
CE

Splitterinstrumente  
Splinter instruments

**HSA 517-55**  
45°  
**Ralk**  
150 mm  
CE



**HSA 511-55**  
**Peet**  
120 mm CE  
Zange für Wurzel- u. Knochensplitter  
forceps for root and bone fragments



**HSA 512-55**  
**Stieglitz**  
140 mm  
CE



**HSA 513-55**  
45°  
**Stieglitz**  
140 mm  
CE



**HSA 514-55**  
90°  
**Stieglitz**  
140 mm  
CE

Zangen für Wurzel- und Knochensplitter, abgebrochene Nervnadeln, festsitzende Papier- und Zelluloidspitzen, zum Einführen von Stiften  
Forceps for root and bone fragments, broken nerve broches, paper and celluloid points, pins etc.

Alle mit CE gekennzeichneten Produkte sind Medizinprodukte. | All products marked with CE are medical devices.

**Endodontie Instrumente  
Endodontics Instruments**



**HWM 039-01**  
Endo-Box, Meßgerät, schnelle und exakte Längeneinstellung  
Endo-Box, measuring gauge, quick and precise length adjustment



**HWJ 033-00**  
3,9 x 1,2 cm  
1 Stück / 1 piece

**Endo Ring**

- Ring aus Edelstahl mit einem Messlineal und einem Stopp.
- Entwickelt, um die Arbeitslänge von Wurzelkanalhandinstrumenten zu messen.
- Schwenkbar; kann jeder gewünschten Richtung angepasst werden.
- Für Rechts- und Linkshänder.
- Für jede Sterilisationsart geeignet.

**Endo Ring**

- Stainless steel ring with a graduated ruler and stop attached.
- Designed to measure the working length of endodontic hand instruments.
- Can be swiveled to suit any desired direction.
- Can be used for right and left hand.
- Will be suitable for any type of decontamination and sterilization.



**HSA 082-13**  
125 mm

Nervzange  
Nerve pliers



**HSC 031-15**  
155 mm

Pinzette mit Schloß  
Forceps with ratchet  
**CE**



**HWG 020-00**

Exkavator aus WIRONIT Stahl  
Excavator from WIRONIT steel

(143/144)  
12 12  
90 10  
13 13  
19 19  
L R

**CE**

## aNervkanal- und Wurzelkanal-Stopfer Nerve-canal and root-canal condensers



**HWH 260-03**  
fig. 0

CE

**HWH 261-05**  
fig. 1

CE

**HWH 262-08**  
fig. 2

CE

**HWH 263-10**  
fig. 3

CE

**HWH 264-13**  
fig. 4

CE



### HWH 259-00

enthält: HWH 260-03 bis HWH 264-13  
contending: HWH 260-03 until HWH 264-13

CE

#### Nervkanal- und Wurzelkanal-Stopfer

- ✓ Merkmale und Verwendungszweck:
- ✓ für die vertikale Kondensation (Verdichtung) von Guttapercha
- ✓ Markierungen in jeweiligem Abstand von 5 mm dienen als Tiefen-Meßhilfe der Pulpakammern

#### Nerve-canal and root-canal condensers

- ✓ Features and application purpose:
- ✓ for the vertical condensation of gutta-percha
- ✓ Markings 5 mm apart are used as a depth measuring aid for the pulp cavities



**αNervkanal- und Wurzelkanal-Stopfer**  
Nerve-canal and root-canal condensers

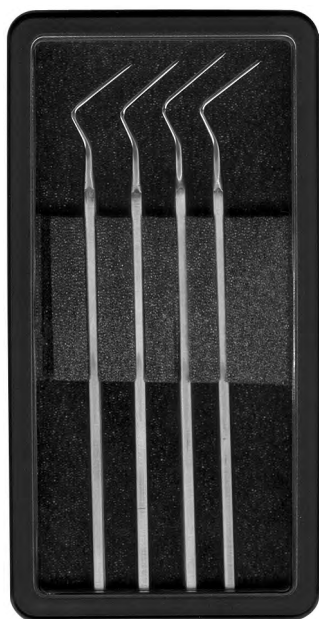

**HWH 271-00**  
enthält: HWH 272-02 bis HWH 271-05  
containing: HWH 272-02 until HWH 271-05  
CE

0,2 mm



**HWH 272-02**  
20  
CE

0,3 mm



**HWH 272-03**  
30  
CE

0,4 mm



**HWH 272-04**  
40  
CE

0,5 mm



**HWH 272-05**  
50  
CE

**Spreizer**

- ✓ Perfektes laterales Kondensieren durch die Abwinkelung und den Spitzenverlauf der Spreizerenden

**Spreader**

- ✓ Perfect lateral condensing due to the way it is angled and to the pointed shape of the spreader ends



**Wironit Instrumente sind aus einer Speziallegierung gefertigt und weisen folgende Vorteile auf:**

- ✓ nichtrostend
- ✓ antimagnetisch
- ✓ säurebeständig

Sie sind formschön, liegen leicht in der Hand und sind von langer Lebensdauer.



**Wironit instruments are made of a special alloy and show the following advantages:**

- ✓ rust resistant
- ✓ anti-magnetic
- ✓ acid resistant

They are beautifully designed and of unlimited durability.

Endodontie Instrumente  
Endodontics Instruments

**HWH 311-01  
Hoffmann**  
sterilisierbar / sterilizable

**Mikrosonde**  
Winkelung links-rechts  
45°horizontal, 90°vertikal  
superspitz

**Micro probe**  
angles left-right 45° horizontal,  
90° vertical  
very fine-tipped

CE



**HWH 312-02  
Hoffmann**  
sterilisierbar / sterilizable

**Mikrofüllspatel**  
doppelendig, Winkelung  
links-rechts 45°

**Micro-spatula for filling**  
double-ended,  
angles left-right 45°

CE



**HWH 316-06  
Hoffmann**  
sterilisierbar / sterilizable

**Mikrostopfer, Zylinder**  
doppelendig, Winkelung links-rechts  
45°horizontal, 90°vertikal  
0,5 mm Zylinder, extrafein

**Micro-plugger, Cylinder**  
double-ended, angles left-right 45°  
horizontal, 90° vertical  
0,5 mm cylinder, extra fine

CE



**HWH 300-01**

**Condenser**  
doppelendig  
Bestens geeignet für  
kleine Anwendungen  
im Frontbereich.

**Condenser**  
double-ended  
Excellent for small  
preparations.

CE



**HWH 301-11**

**Condenser**  
doppelendig  
Bestens geeignet für  
größere Anwendungen  
im Frontbereich.

**Condenser**  
double-ended  
Excellent for larger  
anterior preparations.

CE



**HWH 305-01**  
0,5 mm

**Polier-Instrument  
und Condenser**  
fein

**Burnisher and  
Condenser**  
delicate

CE



**HWH 306-02**  
0,8 mm

**Polier-Instrument  
und Condenser**  
mittel  
**Burnisher and  
Condenser**  
medium

CE

Alle mit CE gekennzeichneten Produkte sind Medizinprodukte. | All products marked with CE are medical devices.





Endodontie Instrumente  
Endodontics Instruments

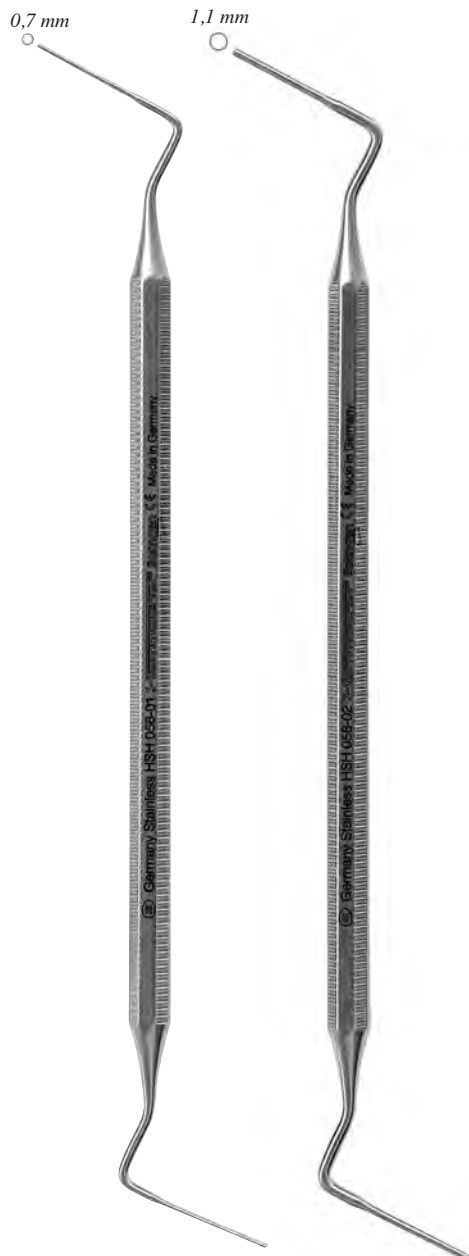

**HSH 058-01**  
Buchanan  
fig. 1

CE

**HSH 058-02**  
Buchanan  
fig. 2

CE

Füllinstrumente  
Filling instruments



**HSL 252-15**  
15 cm  
rostfrei / sterilisierbar  
stainless / sterilizable

Messlineal aus Aluminium  
nur zur Vergleichsmessung  
Measuring ruler from aluminium  
only for comparative measuring



**HSJ 111-08**  
fig. 00  
Ø 8 mm  
Microspiegel  
Micro mirror

**HWC 530-14**  
145 mm  
Greifpinzette, gebogen  
Grasping forceps, curved  
CE



**HWM 032-01**  
50 x 24 x 10 mm

Medikamentenschale  
Medicament cup

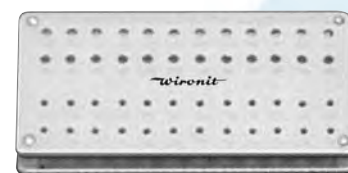

**HWM 029-00**  
78 x 40 x 7 mm

Bohrerstände  
Bur stand

**Hammacher Instrumentensätze – PROFESSIONELL – AKTUELL – UNIVERSELL**  
**Hammacher sets of instruments – PROFESSIONAL – UP-TO-DATE – UNIVERSAL**

## HSG 300-06

**Endodontie Set**  
bestehend aus:

**Endodontic set**  
consisting of:

# SET

### HWM 107-05

180 x 60 x 25 mm  
Sterilisier- und Waschkassetten  
(für 5 Instrumente - mit blauem Silikon - sterilisierbar)  
Sterilising and washing cassettes  
(for 5 instruments – with blue silicone - sterilizable)

### HWJ 091-00

Mundspiegelgriffe, hohl, einfaches Gewinde (M 2,5)  
Handle for mouth mirror, hollow, simple thread

### HSJ 135-04

fig. 4  
22 mm

### „HAMSO“ Front-Mundspiegel

frontverspiegelt, plan (1 VE = 12 Stück)  
Sehr helles, klares Bild – lichtstark  
Reflexion über 90 %  
Farbtreu  
Hohe Kratzfestigkeit  
Für alle gängigen Desinfektionen und Sterilisationsarten  
geeignet  
Temperaturbeständig bis 200°C / 390°F

### „HAMSO“ Front Mouth Mirrors

Front surface, plane (1 package = 12 pieces)  
Very bright and clear picture  
Reflection over 90 %  
Colour fidelity  
Highly scratch-resistant  
Suitable for all usual kinds of disinfection and sterilisation  
Temperature-resistant up to 200°C/390°F

### HWG 020-00

(143/144)  
Exkavator aus WIRONIT Stahl  
Excavator from WIRONIT steel

### HWJ 032-16

Endodontie-Sonde  
Endodontic explorer

### HWH 261-05

fig. 1  
Nervkanal- und Wurzelkanal-Stopfer; aus Wironit Stahl  
Nerve-canal and root-canal condensers, from Wironit steel

### Nervkanal- und Wurzelkanal-Stopfer

Merkmale und Verwendungszweck:  
für die vertikale Kondensation (Verdichtung) von  
Guttapercha  
Markierungen in jeweiligem Abstand von 5 mm dienen als  
Tiefen-Meßhilfe der Pulpakammern

### Nerve-canal and root-canal condensers

Features and application purpose:  
for the vertical condensation of gutta-percha  
Markings 5 mm apart are used as a depth measuring aid for  
the pulp cavities

### HWH 272-03

30  
**Spreizer** Perfektes laterales Kondensieren durch die  
Abwinkelung und den Spitzenverlauf der Spreizerenden  
**Spreader** Perfect lateral condensing due to the way it is  
angled and to the pointed shape of the spreader ends



**HSJ 135-04**  
fig. 4  
22 mm CE



**HWJ 091-00**  
CE



**HWG 020-00**  
(143/144)  
12 12  
90 10  
13 13  
19 19  
L R  
CE



**HWM 107-05**  
180 x 60 x 25 mm  
CE



**HWJ 032-16**  
CE

0,5 mm  
5 mm

0,3 mm



**HWH 261-05**  
fig. 1  
CE

**HWH 272-03**  
30  
CE

**Hammacher Instrumentensätze – PROFESSIONELL – AKTUELL – UNIVERSELL  
Hammacher sets of instruments – PROFESSIONAL – UP-TO-DATE – UNIVERSAL**

**HSH 203-01**

**Kofferdam-Satz**

Nr. 1, 14 teilig, im Aluminium-Tray, bestehend aus:

**Set of rubber-dam**

No. 1, 14 parts, in an Aluminium tray, consisting of:

**SET**



**HSH 203-01**

Kofferdam-Satz Nr. 1, 14 teilig, im Aluminium-Tray, bestehend aus:  
Set of rubber-dam No. 1, 14 parts, in an Aluminium tray, consisting of:

**CE**

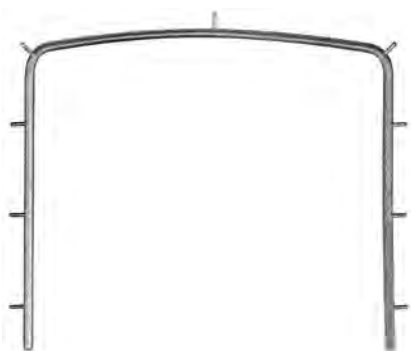

**HSH 171-01**

Kofferdam-Rahmen, für Erwachsene  
Rubber-dam frame, for adults

**CE**

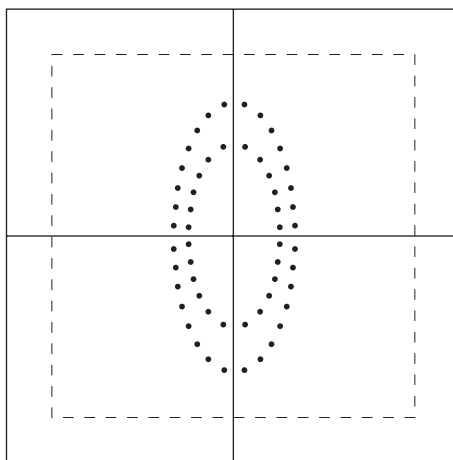

**HSH 199-00**

Kofferdam-Loch-Schablone, aus weißem Kunststoff,  
150 x 150 mm, Auflage für präzises Lochen  
Rubber-dam-template, from white plastic,  
150 x 150 mm, for precise perforation

**CE**

**Klammern  
Clamps**



**HSH 210-00**

*No. 0*  
für Prämolaren  
for premolars

**CE**



**HSH 211-01**

*No. 1*  
für Prämolaren  
for premolars

**CE**



**HSH 212-02**

*No. 2*  
für Prämolaren  
for premolars

**CE**



**HSH 213-07**

*No. 7*  
für Molaren  
for molars

**CE**



**HSH 215-08**

*No. 8*  
für Molaren  
for molars

**CE**



**HSH 216-80**

*No. 8A*  
für Molaren  
for molars

**CE**



**HSH 217-14**

*No. 14A*  
für Molaren  
for molars

**CE**



**HSH 219-21**

*No. 212*  
labial

**CE**

Alle mit CE gekennzeichneten Produkte sind Medizinprodukte. | All products marked with CE are medical devices.

## Hammacher Instrumentensätze – PROFESSIONELL – AKTUELL – UNIVERSELL Hammacher sets of instruments – PROFESSIONAL – UP-TO-DATE – UNIVERSAL

### Produkte aus Aluminium

Folgende Sterilisationsmethoden sind bedenkenlos anzuwenden:

- Autoklav max. 134°, Chemiklav max. 132° oder Heißluftsterilisator max. 180°.
- Beachten Sie die Hinweise der Sterilisatorenhersteller bezüglich der Sterilisationsdauer.
- Benutzen Sie keinen Thermodesinfektor.
- Benutzen Sie kein Ultraschallbad.
- Beachten Sie genau die Vorschriften des Desinfektionshersteller; einige sind für Aluminium nicht geeignet.

### Aluminium products

For sterilisation the following processes can be used safely:

- autoclave max. 134°, chemiclave max. 132° or dry heat max. 180°.
- Refer to manufacturer's instructions for cycle and time process.
- Do not use dish washer.
- Do not use ultrasonic bath.
- Be careful when using disinfecting liquids; some are incompatible with Aluminium; read carefully the directions for use.



**HSH 148-00**  
**Ainsworth**  
170 mm  
Kofferdam-Lochzange  
Rubber-dam cutting forceps

CE

#### Vorzüge:

Die Kofferdam-Lochzange ermöglicht einen sauberen, regelmäßigen Einschnitt im Kofferdam. Sie ist für alle Größenanforderungen verschiedener Spannungen und Verfahren geeignet. Die Lochvorrichtung kann bei Verschleiß leicht und kostengünstig ausgetauscht werden. Leichter Druck bei der Handhabung genügt zur optimalen Anwendung. Keine Korrosionsprobleme.

#### Features:

Ability to cut dam cleanly and regularly. Copes with requirements for all sizes of clamps and techniques. When worn, punch mechanism is easily and cheaply replaced. Only light pressure need be applied for good results. No corrosion problems.



**HSH 200-08**  
Bord für 8 Klammern, rostfrei  
Tray for 8 clamps, stainless



**HSM 260-28**  
Tray, Deckel und Boden,  
leer, 28 x 18 cm, aus Aluminium  
Tray, lid and bottom,  
empty, 28 x 18 cm, from Aluminium



**HSH 190-00**  
Kofferdam, dunkel, medium, vorgeschritten 150 x 150 mm, 36 Stück,  
vakuumverpackt, Stärke 0,18 mm  
Rubber-dam, dark, medium, ready cut 150 x 150 mm, 36 pieces,  
vacuum packed, thickness 0,18 mm

Alle mit CE gekennzeichneten Produkte sind Medizinprodukte. | All products marked with CE are medical devices.

Titan-Pinzetten und Mikro-Klingen  
Titanium-forceps and micro-scalpels

**Titan-Pinzetten:**

- ☑ besonders leicht
- ☑ besonders hygienisch

**Titanium-forceps:**

- ☑ particularly light
- ☑ particularly hygienic

Die Mikro-Klingen sind durch die Doppelschneide und die Ausführung speziell geeignet für die endodontische Chirurgie. Sie entsprechen jeder Ihrer behandlingstechnischen Anforderungen.  
These double-edged micro-scalpels are especially designed for the endodontic surgery. They meet all of your treatment needs.



**HTC 033-05**  
London College  
**"Titan"**  
150 mm  
gerieft  
serrated  
CE



**HTC 036-15**  
**"Titan"**  
150 mm  
gerieft  
serrated  
CE



**HTC 037-15**  
**"Titan"**  
150 mm  
gerieft  
serrated  
CE



**HSO 135-12**  
Griff, rund für Mikro-Klingen HSO 138-62 - HSO 145-04  
Handle, round, for micro-blades HSO 138-62 - HSO 145-04  
CE



**HSO 138-62**  
Mikro-Klingen  
Miko scalpels  
CE  
(1 VE = 10 Stück)  
(1 package = 10 pieces)



**HSO 138-63**  
Mikro-Klingen  
Miko scalpels  
CE  
(1 VE = 10 Stück)  
(1 package = 10 pieces)



**HSO 139-64**  
Mikro-Klingen  
Miko scalpels  
CE



**HSO 140-65**  
Mikro-Klingen  
Miko scalpels  
CE  
(1 VE = 10 Stück)  
(1 package = 10 pieces)



**HSO 145-04**  
Mikro-Klingen  
Miko scalpels  
CE

### Instrumente für die Implantologie

### Instruments for implantology

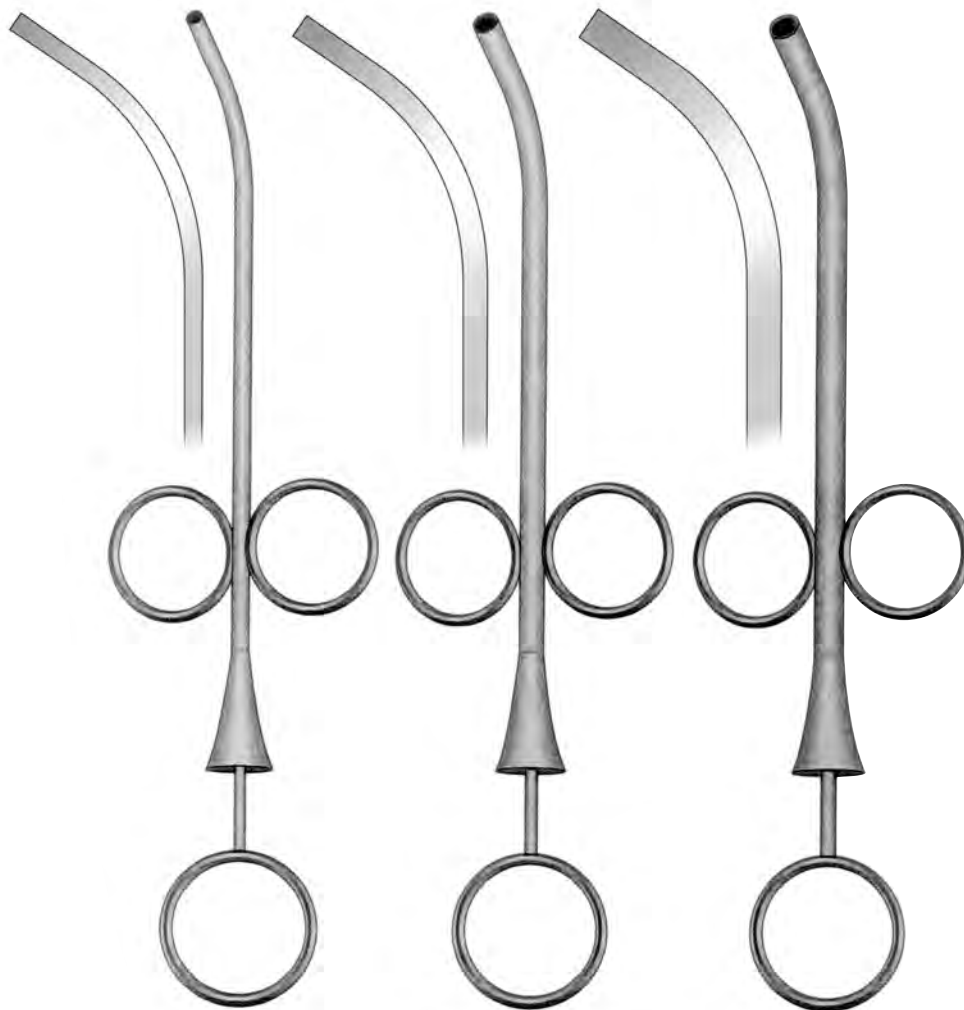

**HSK 338-35**  
160 mm  
I.D. 2,5 mm / O.D. 3,5 mm  
CE

**HSK 338-45**  
160 mm  
I.D. 3,5 mm / O.D. 4,5 mm  
CE

**HSK 338-55**  
160 mm  
I.D. 4,4 mm / O.D. 5,5 mm  
CE

#### **Knochenspritze**

zum Einbringen der gewonnenen Eigenknochenmasse

#### **Bone syringe**

for bringing in the won bone material

**Instrumente für die Implantologie  
Instruments for implantology**

Sehr feine Mikro-Gewebeschere zum exakten Konturieren des Gingivalrandes und des Papillenbereichs  
Very delicate micro tissue scissors for accurate outlining of the gingival crest and the papilla sector

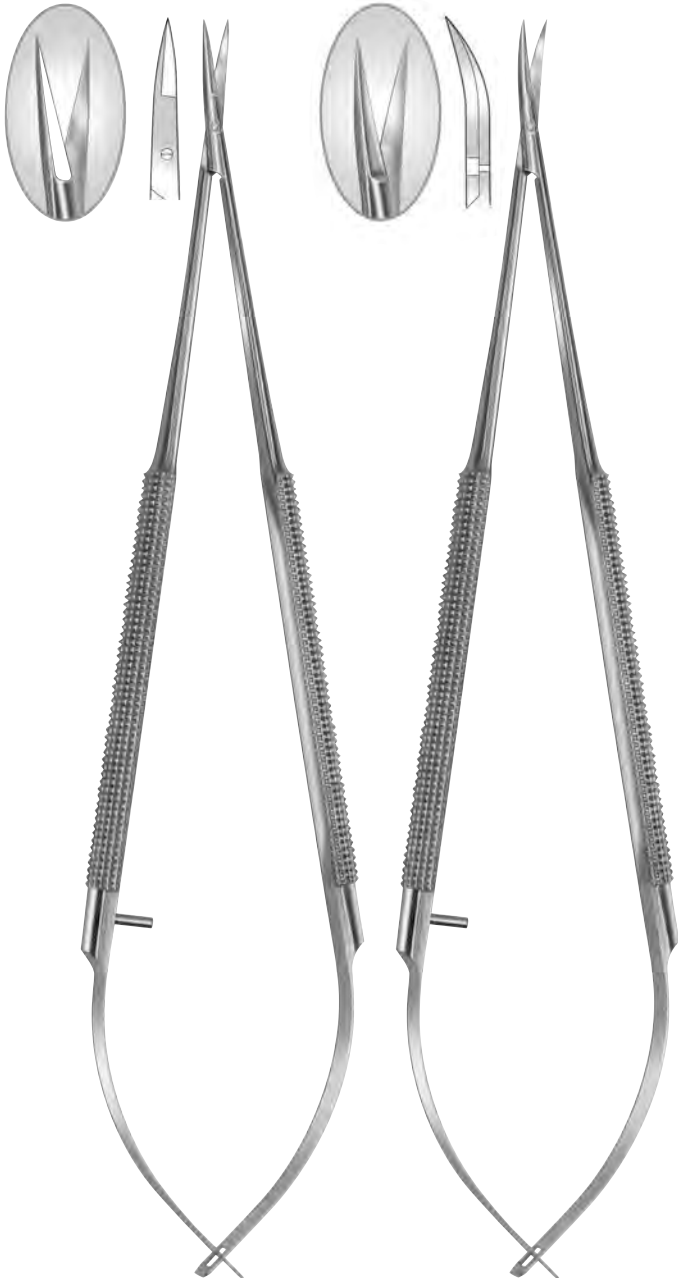

**HSB 556-18**  
180 mm / 7 1/16 inch  
Mikro-Gewebeschere, gerade  
Micro tissue scissors, straight  
CE

**HSB 557-18**  
180 mm / 7 1/16 inch  
Mikro-Gewebeschere, gebogen  
Micro tissue scissors, curved  
CE



**HSF 091-14  
Minnesota**  
140 mm  
Wangen- und Lippenabhalter  
Cheek and lip retractor  
CE



**HSF 092-15**  
Lippenabhalter  
Lip retractor  
CE



**HSF 093-16  
Vestibulum**  
160 mm  
Wangen- und Lippenabhalter / Vestibulum-Haken –  
für das gesamte Vestibulum des Ober- und Unterkiefers  
Cheek and lip retractor / Vestibule-hook –  
for the entire vestibule of the upper and lower jaws  
CE

Alle mit CE gekennzeichneten Produkte sind Medizinprodukte. | All products marked with CE are medical devices.

### Instrumente für die Implantologie

### Instruments for implantology



**HSK 220-14**  
165 mm  
Ø 20 mm, 140 g  
Hämmer mit Bleifüllung  
Mallets, lead filled

**HSK 222-01**  
**Meade**  
185 mm  
Hammer mit auswechselbaren Backen  
Mallet with interchangeable inserts

**HSK 223-00**  
Ersatzbacken zu HSK 222-01, Paar  
Inserts, only for HSK 222-01, pair



**HSK 251-165**  
165 mm

Papillenheber  
zum atraumatischen  
Abpräparieren der Papillen  
Papilla elevator  
for non-traumatic dissection  
of the papillae

CE

**HSK 019-00**  
**Buser**

Raspatorium  
Raspatory

CE

**HSK 023-00**  
175 mm

Platzierinstrument  
Placement instrument

CE



## Sinusbodenaugmentationsatz nach Hoffmann

**Beschreibung:** Beim Operationsverfahren der Sinusbodenaugmentation wird im ersten Schritt eine Knocheninsel aus der latero-facialen Wand des Sinus maxillaris gebildet, deren Luxation auf der Sinusmembran (Schneiderscher Membran) durch leichtes Klopfen mit dem Instrument (HSK 512-00) überprüft wird. Anschließend erfolgt das Eingehen in den knöchernen Sinus unter strengem Knochenkontakt mit Präparation der Sinusmembran nach caudal auf den Sinusboden mit entsprechend abgewinkelten Instrumenten (HSK 505-90 - HSK 509-90) bis eine Mukosaaussackung gewünschter Größe für die Implantation oder Transplantation von heterogenem bzw. allogenen Material erreicht ist. Jetzt kann das vorbereitete Knochen(ersatz)material mit einem konkaven Instrument (HSK 512-00) eingebracht werden und mit dem anderen Ende (HSK 512-00) verdichtet werden.

### Vorteile:

- ✓ Ergonomisches Präparieren mit übersichtlicher Instrumentenanzahl
- ✓ Abwicklungen von 45° und 90° in zwei Ebenen für die sichere Präparation beider Kieferhöhlen aus der 11-, 12- und 1 Uhr-Position
- ✓ Extrafeine Elevatorien für die Präparation von Knochensepten

### Instrumente:

- ▶ HSK 505-90 feine Sinusmembranelevatorien (scharf)  
Winkelung links-rechts 90°horizontal, 90°vertikal
- ▶ HSK 509-90 extrafeine Sinusmembranelevatorien  
Winkelung links-rechts 45°horizontal, 90°vertikal
- ▶ HSK 506-90 feine Sinusmembranelevatorien (scharf)  
Winkelung links-rechts 45°horizontal 90°vertikal
- ▶ HSK 508-90 extrafeine Sinusmembranelevatorien  
Winkelung links-rechts 45°horizontal 90°vertikal
- ▶ HSK 512-00 konkaves Füllinstrument und stempelförmiges  
Perkussions- bzw. Verdichtungsinstrument, 45°gewinkelt

## Sinus Base Augmentation Set (Hoffmann)

**Description:** In the first step of the surgical technique of sinus base augmentation a bony island is formed from the latero-facial wall of the maxillary sinus. The dislocation of this bone island on the sinus membrane (Schneiderian membrane) is tested by lightly tapping with instrument (HSK 512-00). Subsequently, the sinus bone is entered staying strictly with the bone and the sinus membrane is dissected in caudal direction towards the floor of the sinus using suitable angled instruments (HSK 505-90 - HSK 509-90) until a mucosal sac of the desired size for implantation or transplantation of heterogeneous or allogenic material is created. At this point, bone (replacement) material prepared at a prior time can be introduced with a concave instrument (HSK 512-00), and condensed with the opposing end of instrument HSK 512-00.

### Advantages:

- ✓ Ergonomic preparation with a reasonable number of instruments
- ✓ Angles of 45° and 90° at two levels permit safe preparation of both maxillary sinuses from the 11-,12- or 1-o'clock position.
- ✓ Extra-fine elevators for bone septum preparation

### Instruments:

- ▶ HSK 505-90 Fine sinus membrane elevator (sharp),  
angles left-right 90° horizontal, 90° vertical
- ▶ HSK 509-90 Extra-fine sinus membrane elevator,  
angles left-right 45° horizontal, 90° vertical
- ▶ HSK 506-90 Fine sinus membrane elevator (sharp),  
angles left-right 45° horizontal, 90° vertical
- ▶ HSK 508-90 Extra-fine sinus membrane elevator,  
angles left-right 45° horizontal, 90° vertical
- ▶ HSK 512-00 Concave filling instrument and piston-shaped  
percussion and condensing instrument, 45° angle

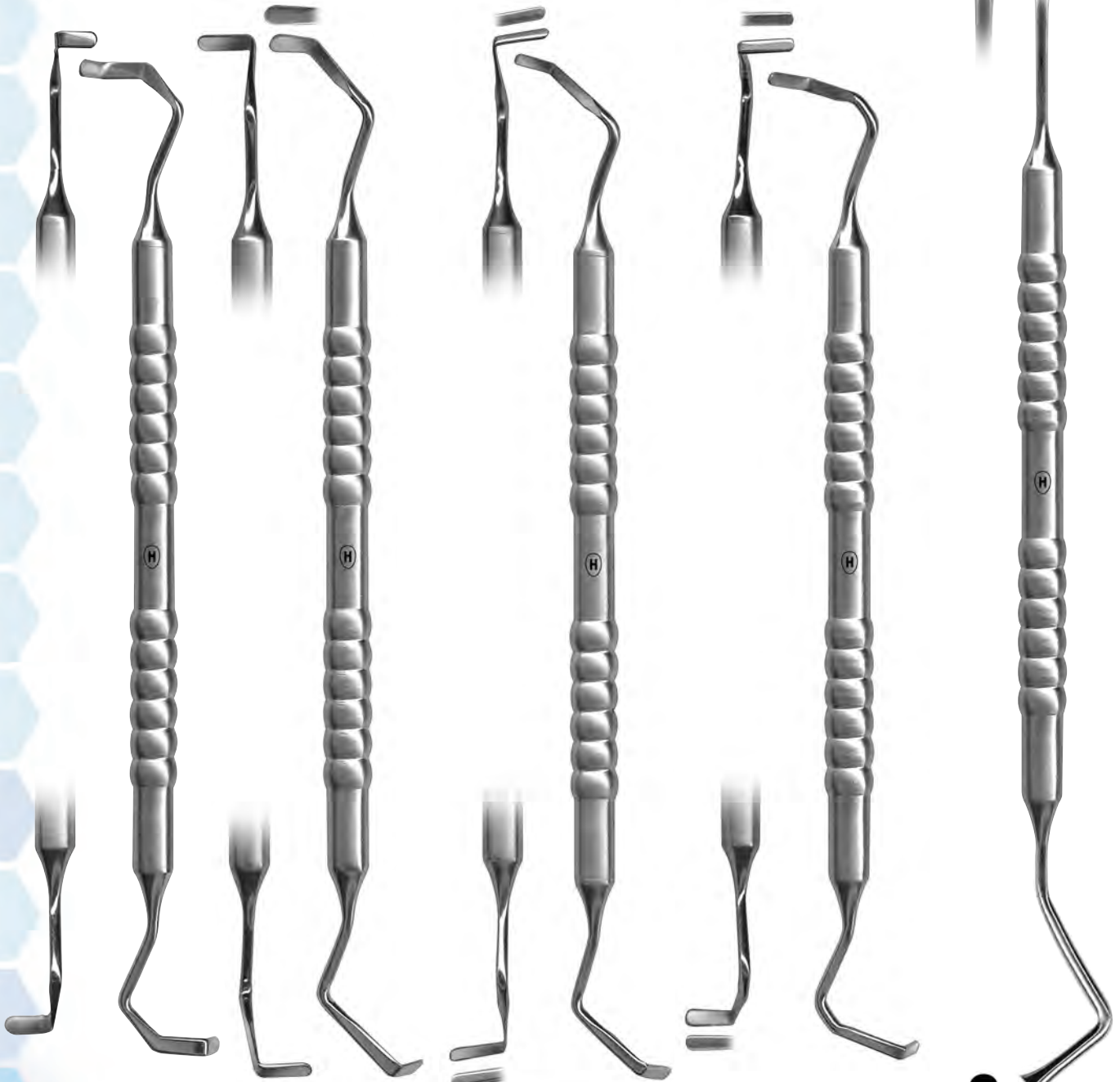
**Master**  
*Line*
**Sinusbodenaugmentationsatz nach Hoffmann**  
**Sinus Base Augmentation Set (Hoffmann)**

**HSK 505-90**  
 3 mm  
 fein, 90°, scharf  
 fine, 90°, sharp

CE

**HSK 506-90**  
 3 mm  
 fein, 45°, scharf  
 fine, 45°, sharp

CE

**HSK 508-90**  
 2/2,5 mm  
 fein, 45°, scharf  
 fine, 45°, sharp

CE

**HSK 509-90**  
 2/2,5 mm  
 fein, 45°, scharf  
 fine, 45°, sharp

CE

**HSK 512-00**  
**Hoffmann**  
 sterilisierbar / sterilizable CE

Konkaves Füllinstrument und  
 stempelförmiges Perkussions- bzw.  
 Verdichtungsinstrument 45° gewinkelt

Concave filling instrument and piston-  
 shaped percussion and condensing  
 instrument 45° angle

Alle mit CE gekennzeichneten Produkte sind Medizinprodukte. | All products marked with CE are medical devices.

Instrumente für die Implantologie  
Instruments for implantology

**Master  
Line**

Sinus Membrane Kürette / Elevatorium  
Sinus Membrane curettes / elevator



**HSK 398-17**  
175 mm  
Ø 6 mm / Ø 5 mm

Membran Lift / Granulatstopfer  
Membrane lift / Granulate plugger

CE

**HSK 397-19**  
190 mm  
Ø 4,5 mm / Ø 3,5 mm

8 – 10 – 13 – 15 – 16 – 18 mm  
Granulatstopfer  
Granulate plugger

CE



**HSK 505-00**  
3 mm  
fein, 90°, scharf  
fine, 90°, sharp

CE



**HSK 506-00**  
3 mm  
fein, 45°, scharf  
fine, 45°, sharp

CE



**HSK 507-00**  
3 mm  
fein, 85°, scharf  
fine, 85°, sharp

CE



**HSK 508-00**  
2/2,5 mm  
fein, 45°, scharf  
fine, 45°, sharp

CE

## Instrumente für die Implantologie Instruments for implantology



**HSK 349-00**

Manuelle Knochenmühle  
zur Zertrümmerung von  
Knochenfragmenten  
Manual bone mill to chop  
bone fragments



**HSK 380-01**

170 mm  
Periotom  
Periotome

CE

**HSK 381-02**

170 mm  
Periotom  
Periotome

CE

**HSK 382-03**

170 mm  
Periotom  
Periotome

CE

Implantologie Pinzetten und Nadelhalter  
Implantology forceps en needle holders



**HSC 261-15**  
155 mm  
6,0 x 0,4 mm

Anatomische Mikro-Pinzette,  
runder Griff, gerade  
Micro dressing tweezers,  
round handle, straight

CE



**HSC 267-15**  
155 mm  
6,0 x 0,4 mm

Chirurgische Mikro-Pinzette  
1:2, runder Griff, gerade  
Micro tissue tweezers 1:2,  
round handle, straight

CE



**HSD 336-18  
Barraquer**  
180 mm / 7 inch  
Mikro-Nadelhalter  
Micro needle holder

CE

Solingen

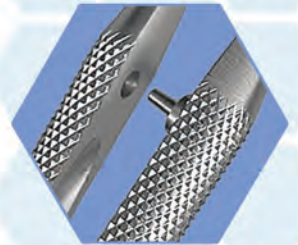

### Instrumente für die Implantologie

### Instruments for implantology

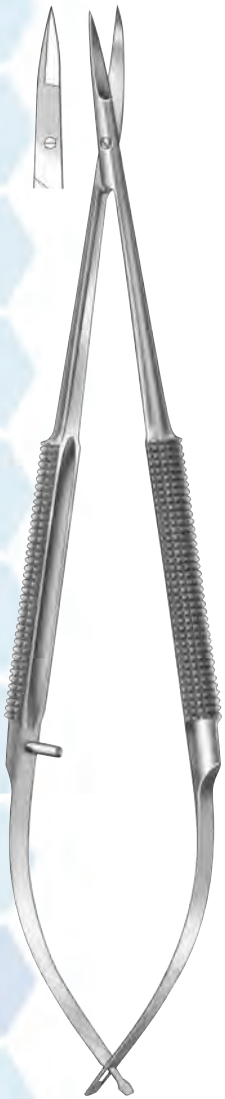

**HSB 554-14**  
140 mm / 5 5/8 inch  
sterilisierbar / sterilizable

gerade  
straight

CE



**HSB 555-14**  
140 mm / 5 5/8 inch  
sterilisierbar / sterilizable

gebogen  
curved

CE

**Mikro-Scheren** mit Rundgriff  
**Micro-scissors** with round handle



**HSJ 114-30**  
Ø 30 mm  
Parallelometer-Spiegel  
Parallelometer mirror



**HWM 087-10**  
10 cl  
Schalen  
Dishes



**HWM 088-25**  
25 cl  
Schalen  
Dishes



**HSJ 104-00**  
Mundspiegelgriffe aus  
rostfreiem Stahl, massiv  
Mouth mirror handles  
from stainless steel, solid

CE

**Instrumente für die Implantologie**  
**Instruments for implantology**



**HSK 347-00**  
35 mm  
Knochenschale  
Bone bowl

CE



4 mm

**HSK 346-92**  
46 mm / 4 mm  
Ersatzklinge zu Knochenschaber  
**HSK 346-03**  
Spare blade for bone scraper  
**HSK 346-03**

CE

**HSK 346-90**  
90 mm / 6 mm  
Ersatzklinge zu Knochenschaber  
**HSK 346-00**  
Spare blade for bone scraper  
**HSK 346-00**

CE



**HSK 346-00**  
170 mm / 7 mm  
Knochenschaber mit scharfer Klinge  
Bone scraper with sharp blade

CE

**HSK 346-03**  
170 mm / 4 mm  
Knochenschaber mit scharfer Klinge  
Bone scraper with sharp blade

CE



**HSK 339-05**  
175 mm

CE

**HSK 339-06**  
175 mm

CE

Stopfer zum Einbringen und Verdichten von Knochenaufbaumaterial bzw. autologem Knochen  
Compactor to place or compress bone substitute respectively autologous bone material



**HSK 345-00**  
170 mm  
Knochenverdichter  
Bone packer

CE

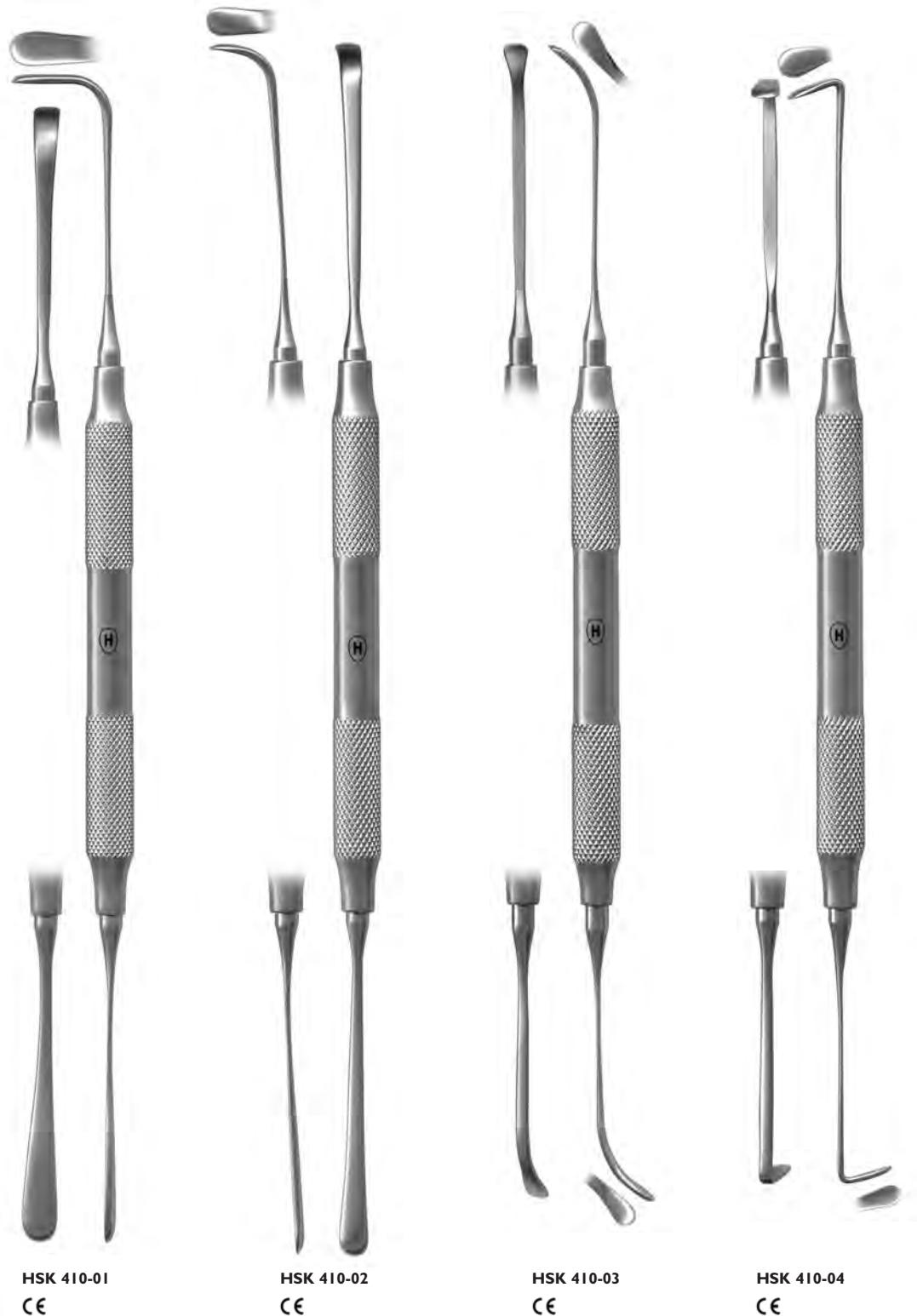
**Flexible Sinus Lift Küretten**  
**Flexible sinus lift curettes**

**Flexible Sinus Lift Küretten** für den direkten Sinus Lift erhöhen durch den einmaligen Schwingeffekt das operative Feingefühl und verringern das Perforationsrisiko der „Schneider’schen Membran“.

**Flexible sinus lift curettes** for the direct sinus lift increase the operational sensitivity and reduce the perforation risk of the "Schneider'sche membrane" due to the unique swing effect.

Alle mit CE gekennzeichneten Produkte sind Medizinprodukte. | All products marked with CE are medical devices.



Sinus Lift Küretten  
Sinus lift curettes



**HSK 411-01**  
190mm  
stumpf  
blunt  
CE

**HSK 411-02**  
190mm  
stumpf  
blunt  
CE

**HSK 411-03**  
190mm  
stumpf  
blunt  
CE

**HSK 411-04**  
190mm  
stumpf  
blunt  
CE

**HSK 411-05**  
190mm  
stumpf  
blunt  
CE

**Sinus Lift Küretten**  
**Sinus lift curettes**

**HSK 411-06**  
 190mm  
 stumpf  
 blunt  
 CE



**HSK 411-07**  
 190mm  
 stumpf  
 blunt  
 CE



**HSK 411-08**  
 190mm  
 stumpf  
 blunt  
 CE



**HSK 411-09**  
 190mm  
 stumpf  
 blunt  
 CE



**HSK 411-10**  
 190mm  
 stumpf  
 blunt  
 CE

Sinus Lift Küretten  
Sinus lift cures

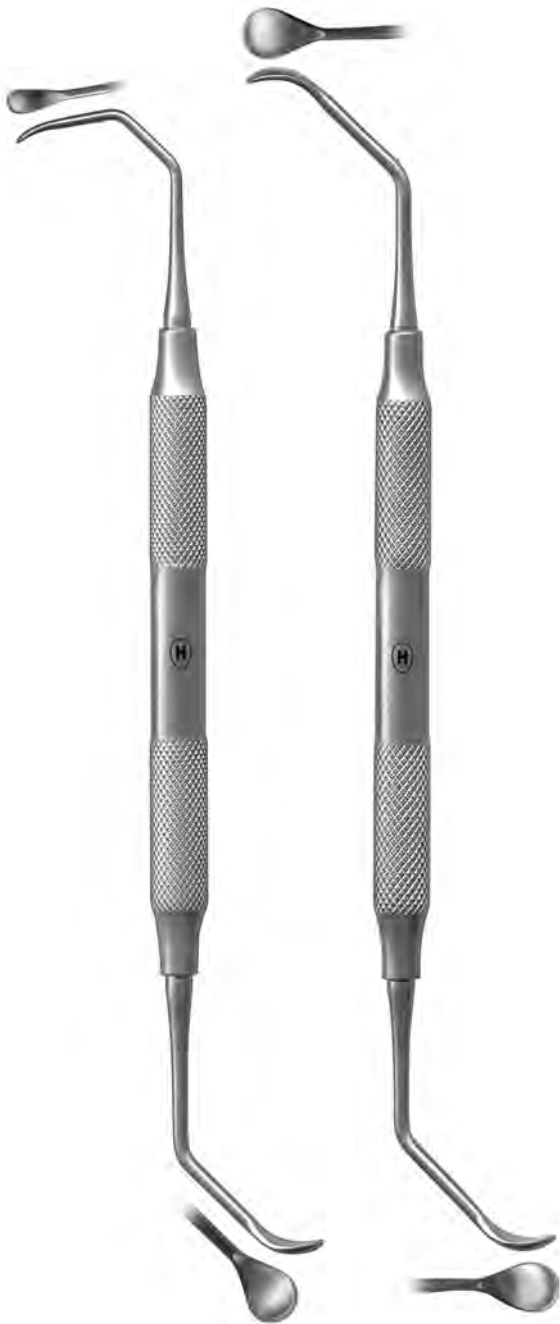

**HSK 411-11**  
170mm  
CE

**HSK 411-12**  
170mm  
CE



**HSK 411-13**  
170mm  
CE



**HSK 411-14**  
170mm  
CE



**HSK 411-15**  
170mm  
CE

### Osteotome

#### Osteotomes

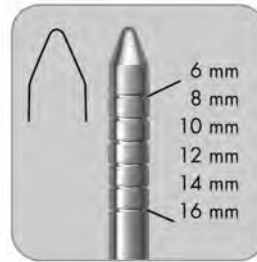

**HSK 462-20**  
160 mm  
Ø 2,0 mm  
CE



**HSK 462-27**  
160 mm  
Ø 2,7 mm  
CE



**HSK 462-32**  
160 mm  
Ø 3,2 mm  
CE



**HSK 462-37**  
160 mm  
Ø 3,7 mm  
CE



**HSK 462-42**  
160 mm  
Ø 4,2 mm  
CE



**HSK 462-50**  
160 mm  
Ø 5,0 mm  
CE



**HSK 462-60**  
160 mm  
Ø 6,0 mm  
CE

Alle mit CE gekennzeichneten Produkte sind Medizinprodukte. | All products marked with CE are medical devices.

Osteotome  
Osteotomes

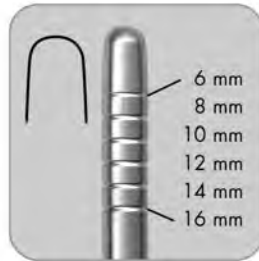

**HSK 464-20**  
160 mm  
Ø 2,0 mm  
CE



**HSK 464-27**  
160 mm  
Ø 2,7 mm  
CE



**HSK 464-32**  
160 mm  
Ø 3,2 mm  
CE



**HSK 464-37**  
160 mm  
Ø 3,7 mm  
CE



**HSK 464-42**  
160 mm  
Ø 4,2 mm  
CE



**HSK 464-50**  
160 mm  
Ø 5,0 mm  
CE



**HSK 464-60**  
160 mm  
Ø 6,0 mm  
CE

### Osteotome

#### Osteotomes



**HSK 466-20**  
160 mm  
Ø 2,0 mm  
CE



**HSK 466-27**  
160 mm  
Ø 2,7 mm  
CE



**HSK 466-32**  
160 mm  
Ø 3,2 mm  
CE



**HSK 466-37**  
160 mm  
Ø 3,7 mm  
CE



**HSK 466-42**  
160 mm  
Ø 4,2 mm  
CE



**HSK 466-50**  
160 mm  
Ø 5,0 mm  
CE



**HSK 462-60**  
160 mm  
Ø 6,0 mm  
CE

Osteotome  
Osteotomes



**HSK 461-20**  
175 mm  
Ø 2,0 mm

CE



**HSK 461-27**  
175 mm  
Ø 2,7 mm

CE



**HSK 461-32**  
175 mm  
Ø 3,2 mm

CE



**HSK 461-37**  
175 mm  
Ø 3,7 mm

CE



**HSK 461-42**  
175 mm  
Ø 4,2 mm

CE



**HSK 461-50**  
175 mm  
Ø 5,0 mm

CE



**HSK 461-60**  
175 mm  
Ø 6,0 mm

CE

Alle mit CE gekennzeichneten Produkte sind Medizinprodukte. | All products marked with CE are medical devices.

### Osteotome Osteotomes



**HSK 463-20**  
175 mm  
Ø 2,0 mm

CE



**HSK 463-27**  
175 mm  
Ø 2,7 mm

CE



**HSK 463-32**  
175 mm  
Ø 3,2 mm

CE



**HSK 463-37**  
175 mm  
Ø 3,7 mm

CE



**HSK 463-42**  
175 mm  
Ø 4,2 mm

CE



**HSK 463-50**  
175 mm  
Ø 5,0 mm

CE



**HSK 463-60**  
175 mm  
Ø 6,0 mm

CE

Alle mit CE gekennzeichneten Produkte sind Medizinprodukte. | All products marked with CE are medical devices.



Osteotome  
Osteotomes



**HSK 465-20**  
175 mm  
Ø 2,0 mm  
CE



**HSK 465-27**  
175 mm  
Ø 2,7 mm  
CE



**HSK 465-32**  
175 mm  
Ø 3,2 mm  
CE



**HSK 465-37**  
175 mm  
Ø 3,7 mm  
CE



**HSK 465-42**  
175 mm  
Ø 4,2 mm  
CE



**HSK 465-50**  
175 mm  
Ø 5,0 mm  
CE



**HSK 465-60**  
175 mm  
Ø 6,0 mm  
CE

Alle mit CE gekennzeichneten Produkte sind Medizinprodukte. | All products marked with CE are medical devices.

Osteotome  
Osteotomes

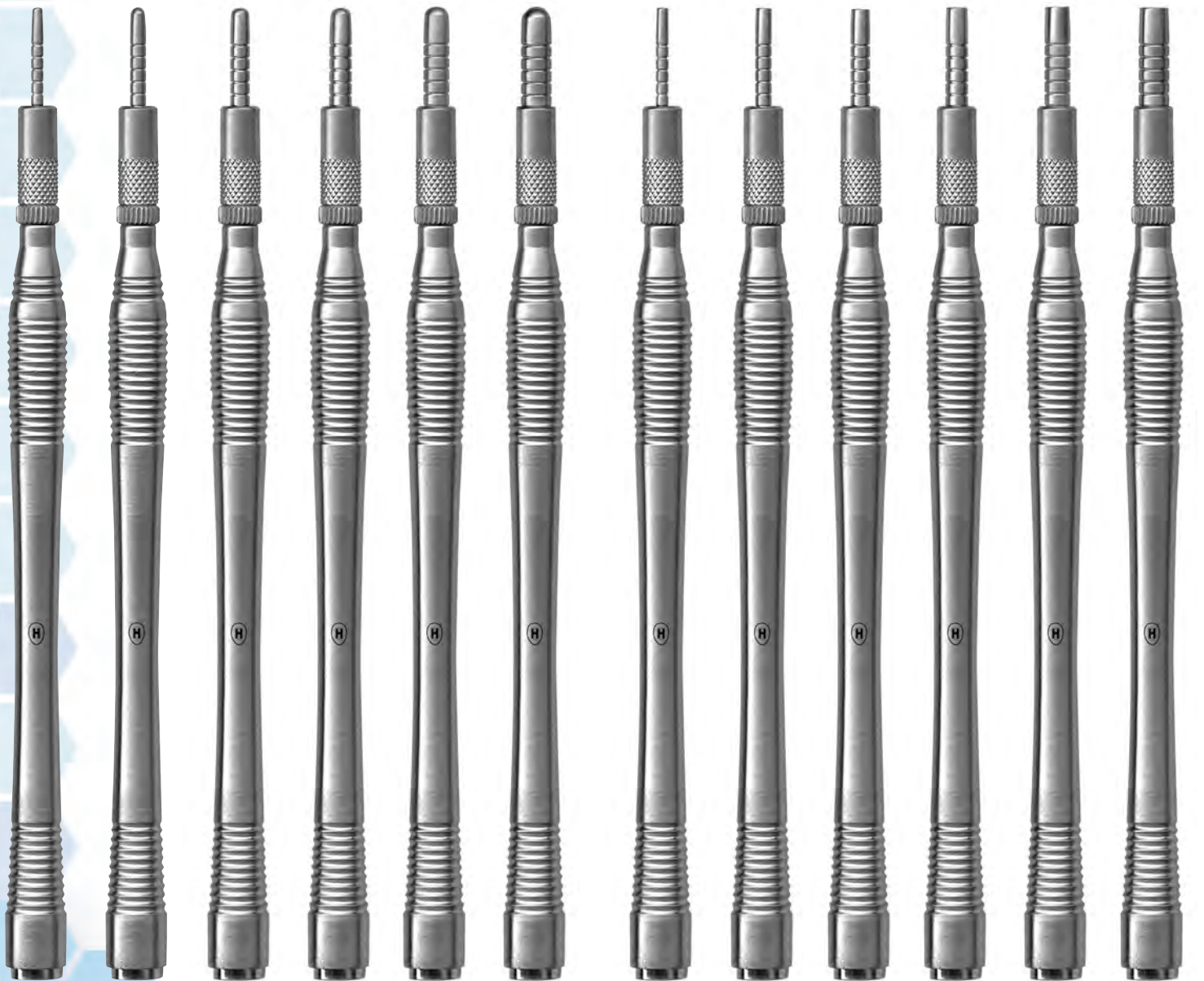

**HSK 468-20**  
160 mm  
Ø 2,0 mm

**HSK 468-27**  
160 mm  
Ø 2,7 mm

**HSK 468-32**  
160 mm  
Ø 3,2 mm

**HSK 468-37**  
160 mm  
Ø 3,7 mm

**HSK 468-42**  
160 mm  
Ø 4,2 mm

**HSK 468-50**  
175 mm  
Ø 5 mm

**HSK 470-20**  
160 mm  
Ø 2,0 mm

**HSK 470-27**  
160 mm  
Ø 2,7 mm

**HSK 470-32**  
160 mm  
Ø 3,2 mm

**HSK 470-37**  
160 mm  
Ø 3,7 mm

**HSK 470-42**  
160 mm  
Ø 4,2 mm

**HSK 470-50**  
175 mm  
Ø 5 mm

CE

CE

CE

CE

CE

CE

CE

CE

CE

CE

CE

CE

Osteotome  
Osteotomes



<b>HSK 469-20</b>	<b>HSK 469-27</b>	<b>HSK 469-32</b>	<b>HSK 469-37</b>	<b>HSK 469-42</b>	<b>HSK 469-50</b>	<b>HSK 471-20</b>	<b>HSK 471-27</b>	<b>HSK 471-32</b>	<b>HSK 471-37</b>	<b>HSK 471-42</b>	<b>HSK 471-50</b>
175 mm	175 mm	175 mm	175 mm	175 mm	175 mm	175 mm	175 mm	175 mm	175 mm	175 mm	175 mm
Ø 2,0 mm	Ø 2,7 mm	Ø 3,2 mm	Ø 3,7 mm	Ø 4,2 mm	Ø 5 mm	Ø 2,0 mm	Ø 2,7 mm	Ø 3,2 mm	Ø 3,7 mm	Ø 4,2 mm	Ø 5 mm
CE	CE	CE	CE	CE	CE	CE	CE	CE	CE	CE	CE

Alle mit CE gekennzeichneten Produkte sind Medizinprodukte. | All products marked with CE are medical devices.

## Knochenerweiterungssystem und Meißel Bone spreading system and Chisels



### Knochenerweiterungssystem

- ✓ zur lokalen Erweiterung des Knochens vor der Implantation
- ✓ mit Farbkodierung für mehr Sicherheit und Effektivität

### Bone spreading system

- ✓ for the local enlargement of the bone before the implantation
- ✓ with color coding for more security and effectiveness

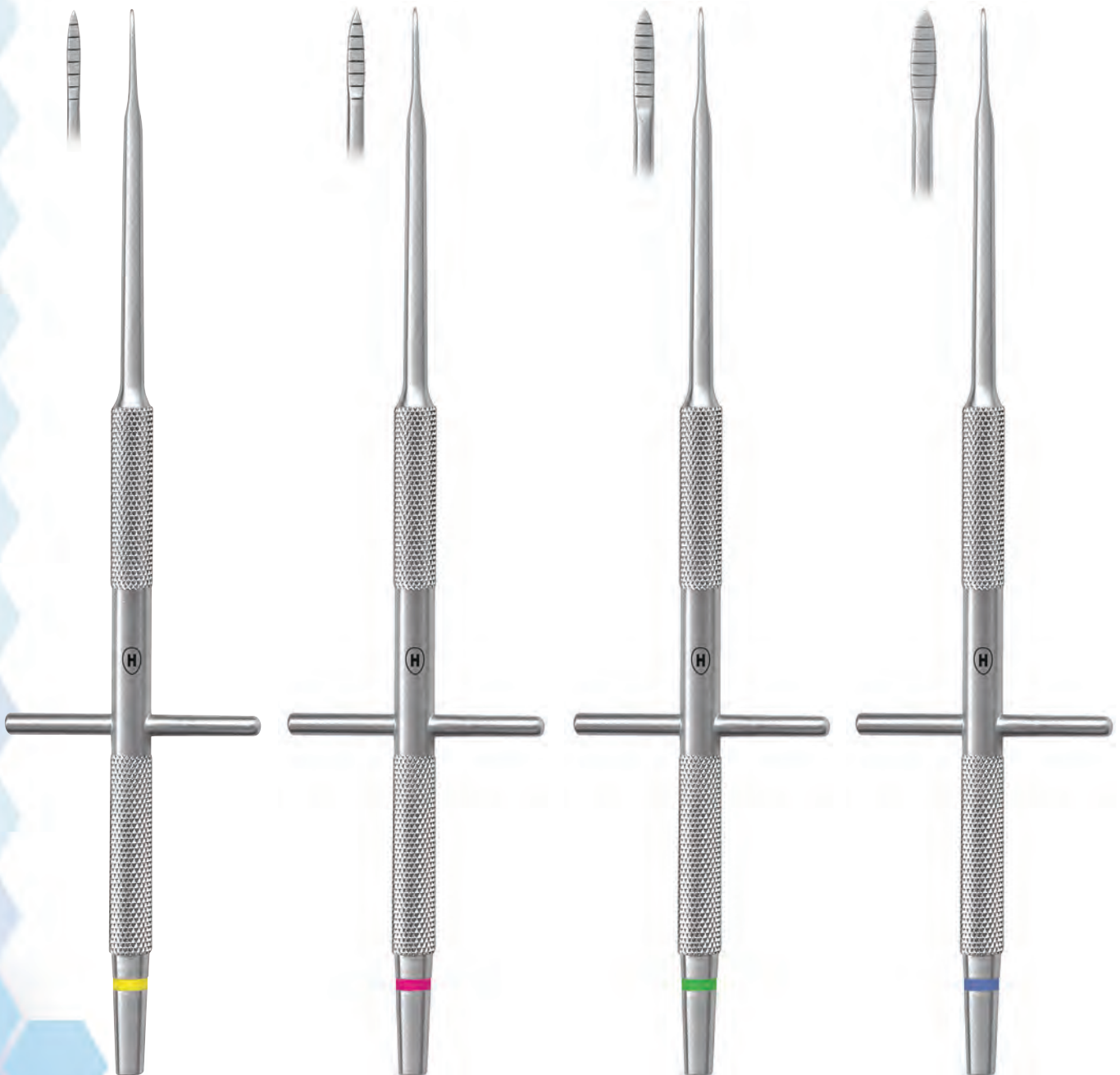
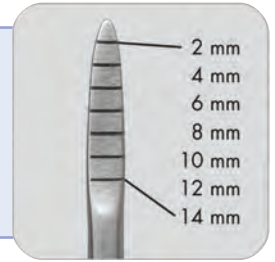

**HSK 412-22**

170 mm  
Ø 2,2 mm



**HSK 412-28**

170 mm  
Ø 2,8 mm



**HSK 412-34**

170 mm  
Ø 3,4 mm



**HSK 412-40**

170 mm  
Ø 4,0 mm



Alle mit CE gekennzeichneten Produkte sind Medizinprodukte. | All products marked with CE are medical devices.

**Knochenerweiterungssystem und Meißel**  
**Bone spreading system and Chisels**



**Knochenerweiterungssystem**

- ✓ zur lokalen Erweiterung des Knochens vor der Implantation
- ✓ mit Farbkodierung für mehr Sicherheit und Effektivität

**Bone spreading system**

- ✓ for the local enlargement of the bone before the implantation
- ✓ with color coding for more security and effectiveness

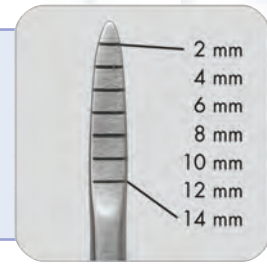

**HSK 413-22**  
170 mm  
Ø 2,2 mm  
CE



**HSK 413-28**  
170 mm  
Ø 2,8 mm  
CE



**HSK 413-34**  
170 mm  
Ø 3,4 mm  
CE



**HSK 413-40**  
170 mm  
Ø 4,0 mm  
CE

Alle mit CE gekennzeichneten Produkte sind Medizinprodukte. | All products marked with CE are medical devices.

**Knochenerweiterungssystem und Meißel**  
**Bone spreading system and Chisels**

**HSK 228-40**  
 170 mm  
 4,0 mm  
 gerade  
 straight

CE



**HSK 228-75**  
 170 mm  
 7,5 mm  
 gerade  
 straight

CE



**HSK 229-40**  
 170 mm  
 4,0 mm  
 gebogen  
 curved

CE



**HSK 229-75**  
 170 mm  
 7,5 mm  
 gebogen  
 curved

CE



Exkavatoren  
Excavators

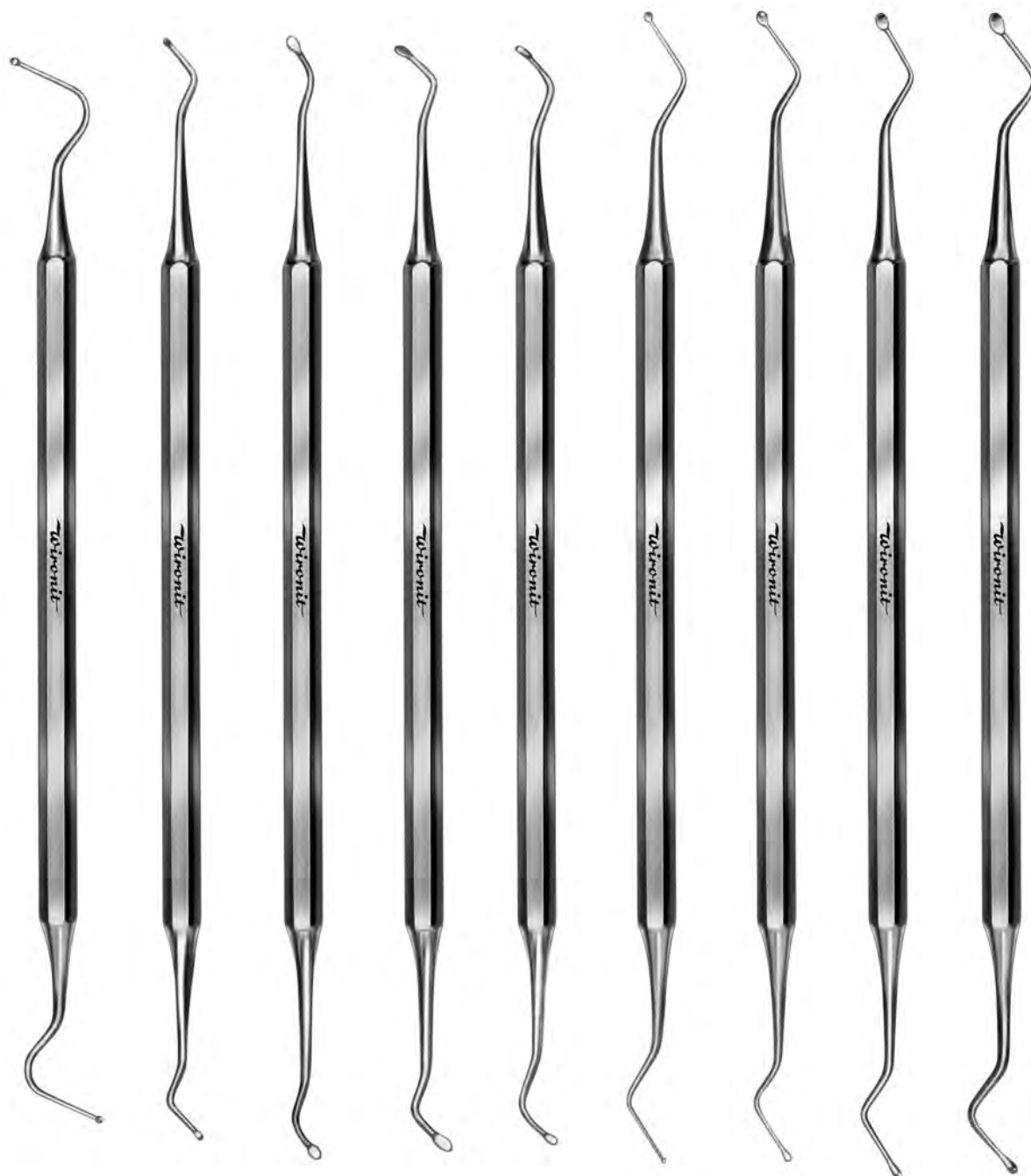

**wironit**  
Instrumente

- ☑ nichtrostend
- ☑ antimagnetisch
- ☑ säurebeständig
- ☑ formschön
- ☑ leicht in der Hand
- ☑ von langer Lebensdauer

---

**wironit**  
Instrumente

- ☑ rust resistant
- ☑ anti-magnetic
- ☑ acid resistant
- ☑ beautifully designed
- ☑ light in the hand
- ☑ unlimited durability

<b>HWG 020-00</b> (143/144)	<b>HWG 021-00</b> (153/154)	<b>HWG 022-00</b> (155/156)	<b>HWG 023-00</b> (157/158)	<b>HWG 024-00</b> (159/160)	<b>HWG 030-00</b> CE	<b>HWG 031-00</b> CE	<b>HWG 032-00</b> CE	<b>HWG 033-00</b> CE
12 12	10 10	12 12	14 14	17 17				
90 10	90 10	90 10	90 10	90 10				
13 13	6 6	6 6	6 6	6 6				
19 19	10 10	10 10	10 10	10 10				
L R	L R	L R	L R	L R				
CE	CE	CE	CE	CE				

Alle mit CE gekennzeichneten Produkte sind Medizinprodukte. | All products marked with CE are medical devices.

# Konservierende Behandlung Conservative treatment

Exkavatoren  
Excavators



doppelendig mit Achtkantgriff  
double-ended with octagonal handle

doppelendig mit Rundgriffen  
double-ended with round handles

**Wironit**  
Instrumente

- ☑ nichtrostend
- ☑ antimagnetisch
- ☑ säurebeständig
- ☑ formschön
- ☑ leicht in der Hand
- ☑ von langer Lebensdauer

**Wironit**  
Instrumente

- ☑ rust resistant
- ☑ anti-magnetic
- ☑ acid resistant
- ☑ beautifully designed
- ☑ light in the hand
- ☑ unlimited durability

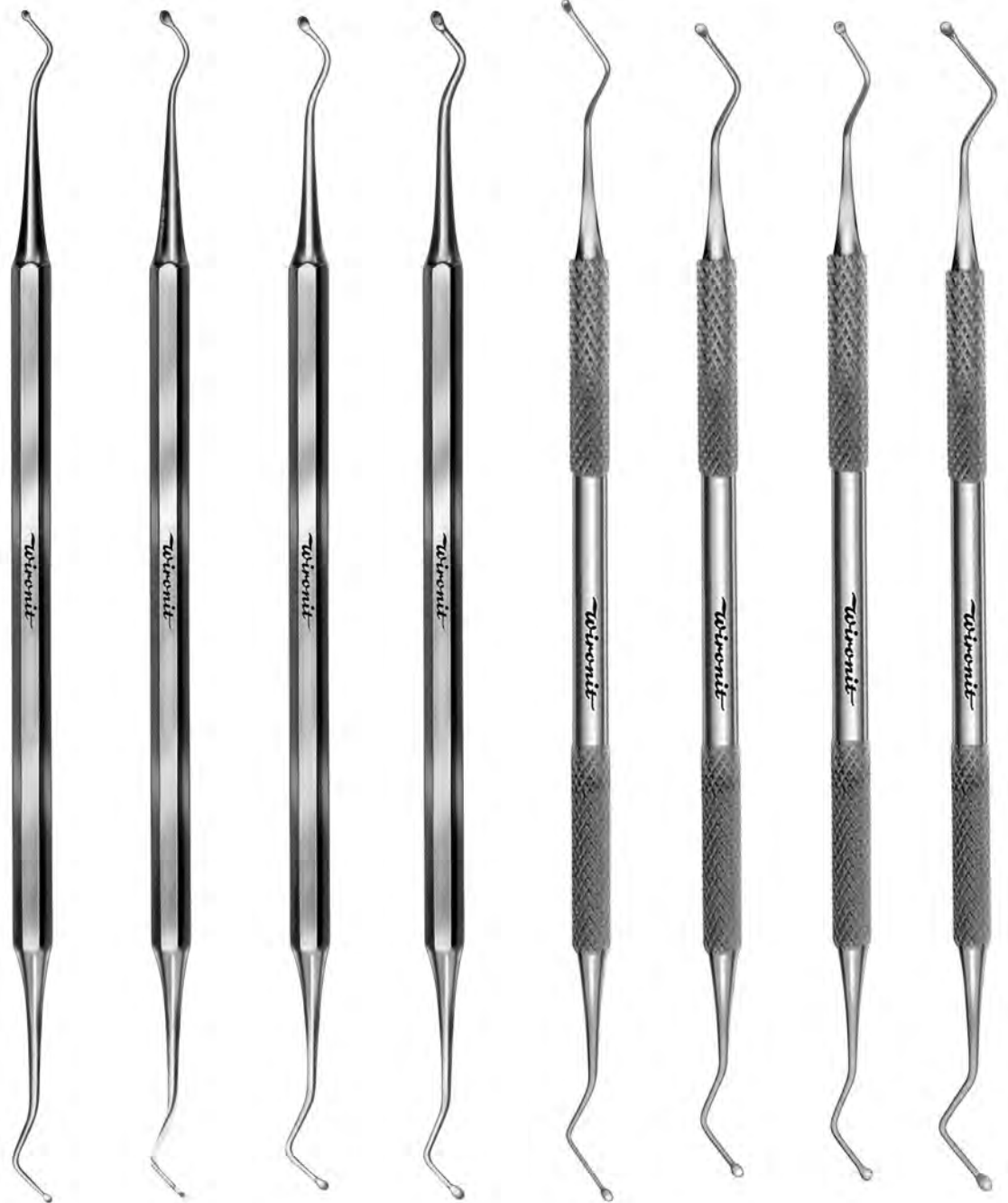

HWG 036-00 (131/132)	HWG 037-00 (129/130)	HWG 038-00 (127/128)	HWG 039-00 (125/126)	HWG 055-00	HWG 056-00	HWG 057-00	HWG 058-00
14 14	17 17	20 20	25 25	CE	CE	CE	CE
90 10	90 10	90 10	90 10				
9 9	9 9	9 9	9 9				
8 8	8 8	8 8	8 8				
L R	L R	L R	L R				
CE	CE	CE	CE				

Alle mit CE gekennzeichneten Produkte sind Medizinprodukte. | All products marked with CE are medical devices.



# Konservierende Behandlung Conservative treatment

7

## Exkavatoren Excavators

Der Erfolg von PPSU kann auf mehrere wichtige Leistungsmerkmale zurückgeführt werden, die diesem Polymer eigen sind:

- ✓ Hohe Hitzebeständigkeit
- ✓ Langzeitwärmestabilität
- ✓ Beständigkeit gegen längere Hitzeeinwirkung
- ✓ Breites Spektrum an chemischer Beständigkeit
- ✓ Außergewöhnliche Zähigkeit und Haltbarkeit

The success of PPSU can be attributed to several key performance attributes that are inherent to the polymer:

- ✓ High heat resistance
- ✓ Long-term thermal stability
- ✓ Resistance to prolonged hot water exposure
- ✓ Broad range of chemical resistance
- ✓ Exceptional toughness and durability

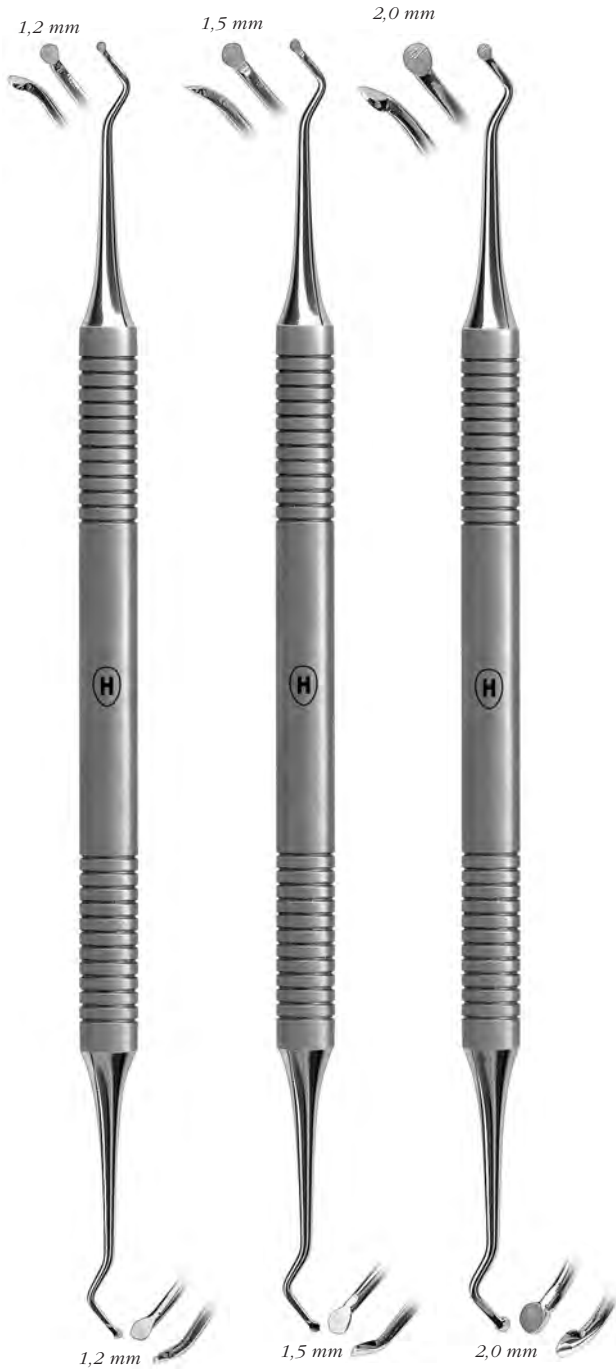

**HSG 026-17**  
No. 17  
CE

**HSG 027-18**  
No. 18  
CE

**HSG 028-19**  
No. 19  
CE

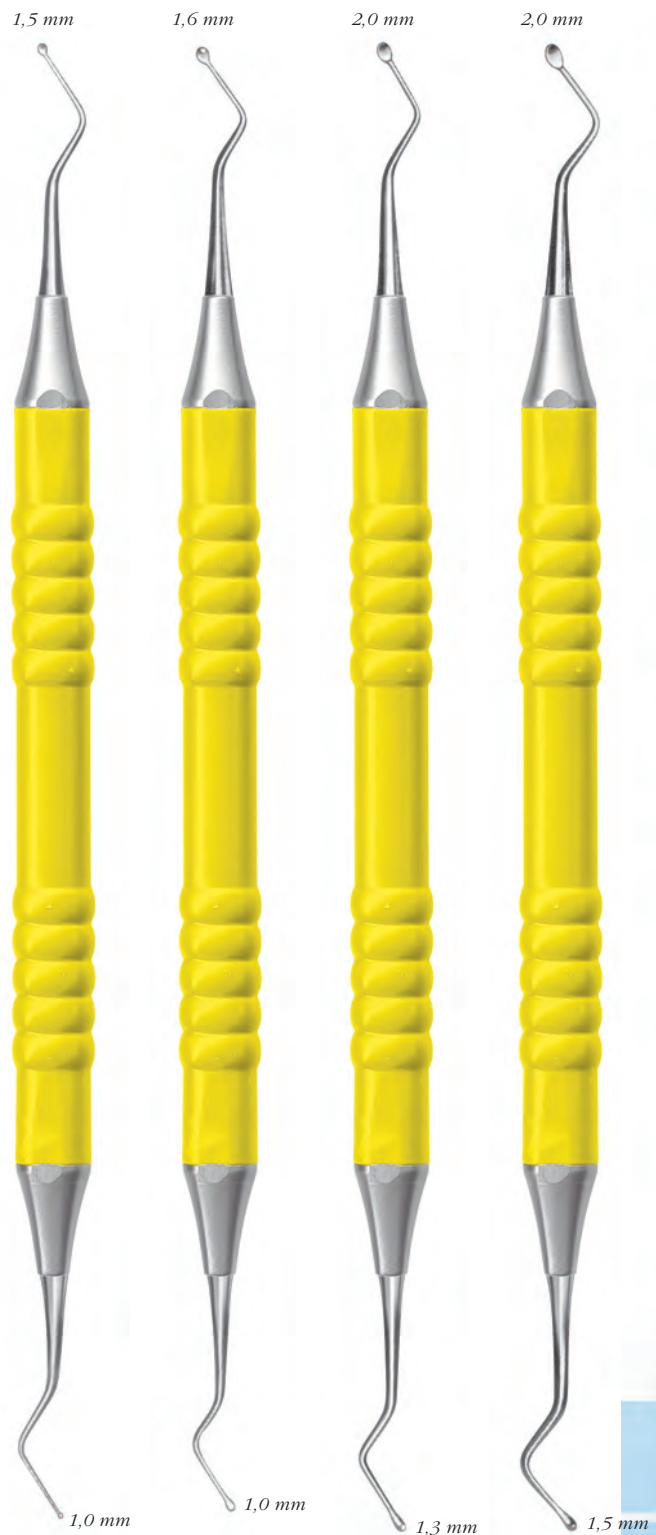

**HSR 030-00**  
CE

**HSR 031-00**  
CE

**HSR 032-00**  
CE

**HSR 033-00**  
CE

Exkavatoren mit PPSU-Griff, sterilisierbar  
Excavators with PPSU handle, sterilizable

Alle mit CE gekennzeichneten Produkte sind Medizinprodukte. | All products marked with CE are medical devices.

## Konservierende Behandlung Conservative treatment

Exkavatoren mit Achtkantgriff Ø 5,5 mm – perfekter Schliff für langanhaltende Schärfe  
Excavators with octagonal handle Ø 5,5 mm – perfect cut for long-lasting sharpness

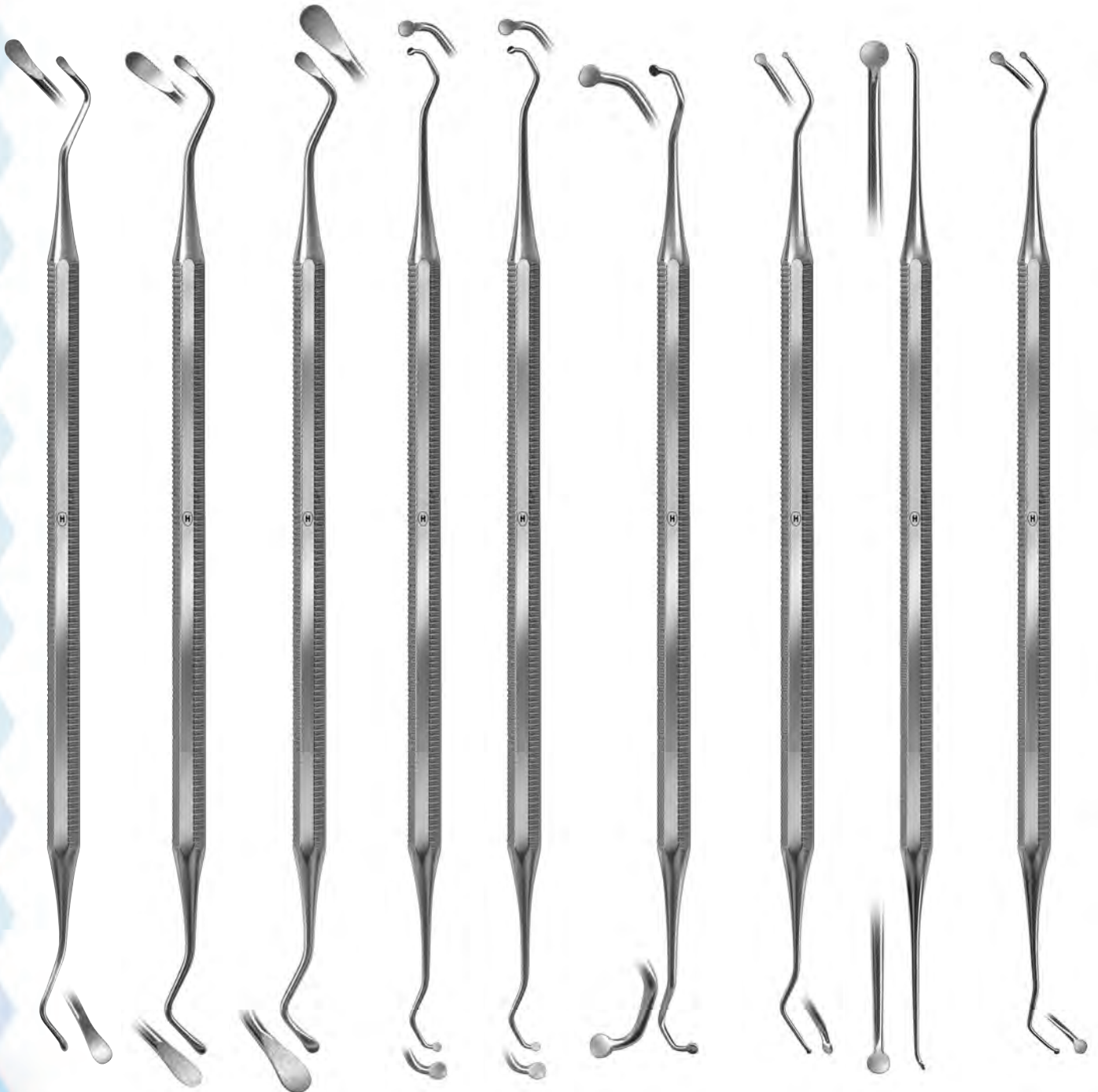

**HSG 025-01**  
*EXC17*

CE

**HSG 025-02**  
*EXC18*

CE

**HSG 025-03**  
*EXC19*

CE

**HSG 025-04**  
*243*

CE

**HSG 025-05**  
*244*

CE

**HSG 025-06**  
*245*

CE

**HSG 025-07**  
*133/134*

CE

**HSG 025-08**  
*73/74*

CE

**HSG 025-09**  
*153/154*

CE

**Schmelzmesser, Schneidende Instrumente und Gingivalrandschräger**  
**Enamel chisels, Cutting instruments and Margin trimmers**

Zur Betonung der Unterschnitte und Stufenwinkel und zum Glätten der gingivalen Schmelzränder mit gebogenen Arbeitsenden und abgeschrägten Schneidekanten  
Used to produce proper bevel on enamel margins with curved blade and angled cutting edge

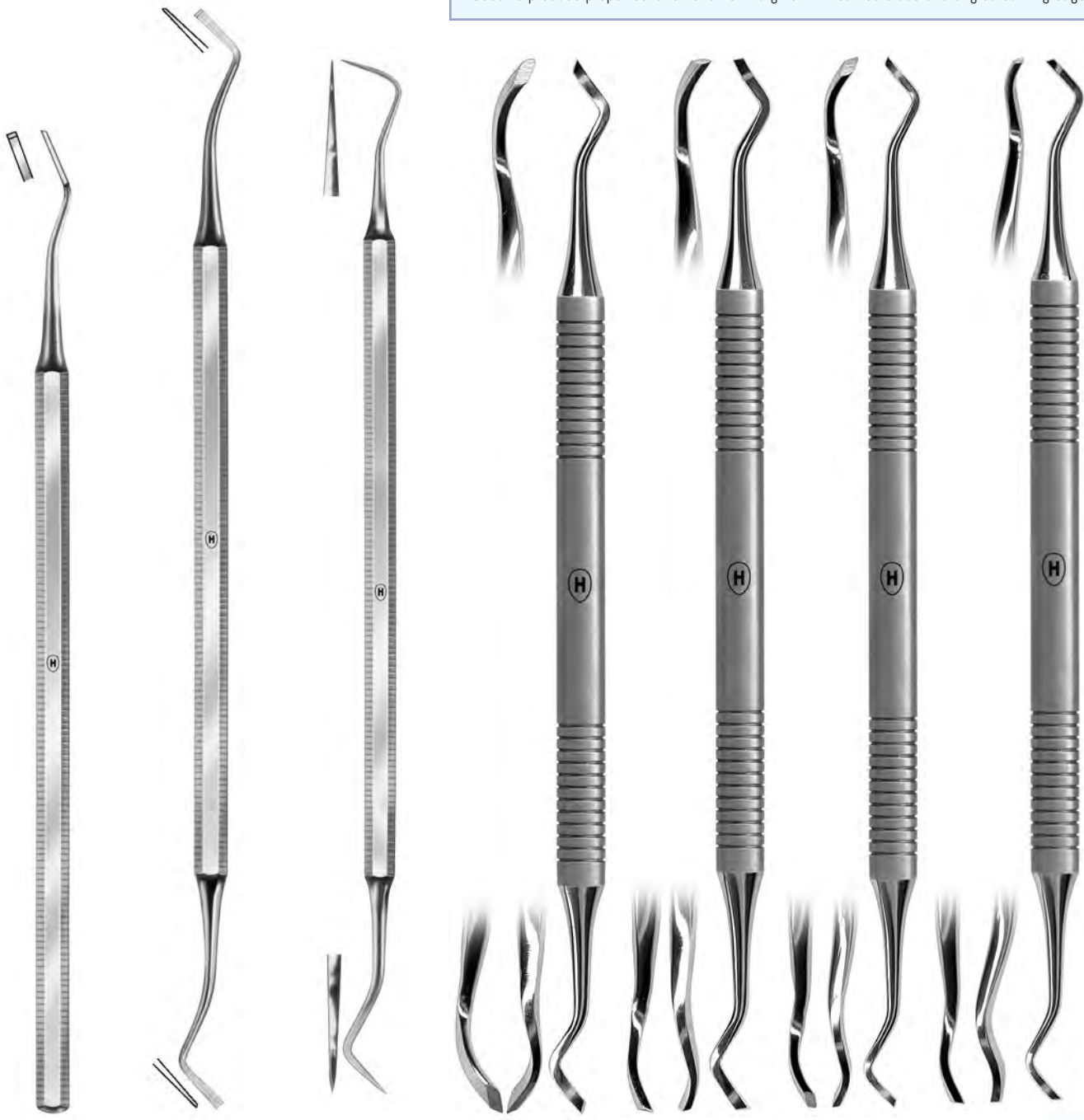

**HSG 043-81**  
(81)  
20  
9  
Schmelzmesser  
Enamel chisels  
CE

**HSG 020-00**  
(51/52)  
**Black**  
15 15  
8 8  
12 12  
L R  
Schneidende Instrumente  
Cutting instruments  
CE

**HSJ 058-01**  
*fig. 1*  
**Lange**  
Cavitheber  
Cavit lifter  
CE

**HSG 030-26**  
No. 26  
[13-95-8-14]  
**Distal**  
CE

**HSG 031-27**  
No. 27  
[13-80-8-14]  
**Mesial**  
CE

**HSG 032-28**  
No. 28  
[10-95-7-14]  
**Distal**  
CE

**HSG 033-29**  
No. 29  
[10-80-7-14]  
**Mesial**  
CE

Gingivalrandschräger  
Margin trimmers

Alle mit CE gekennzeichneten Produkte sind Medizinprodukte. | All products marked with CE are medical devices.

**Konservierende Behandlung**  
**Conservative treatment**

**Wiro-FILL Komposite Instrumente**  
**Wiro-FILL Composite instruments**

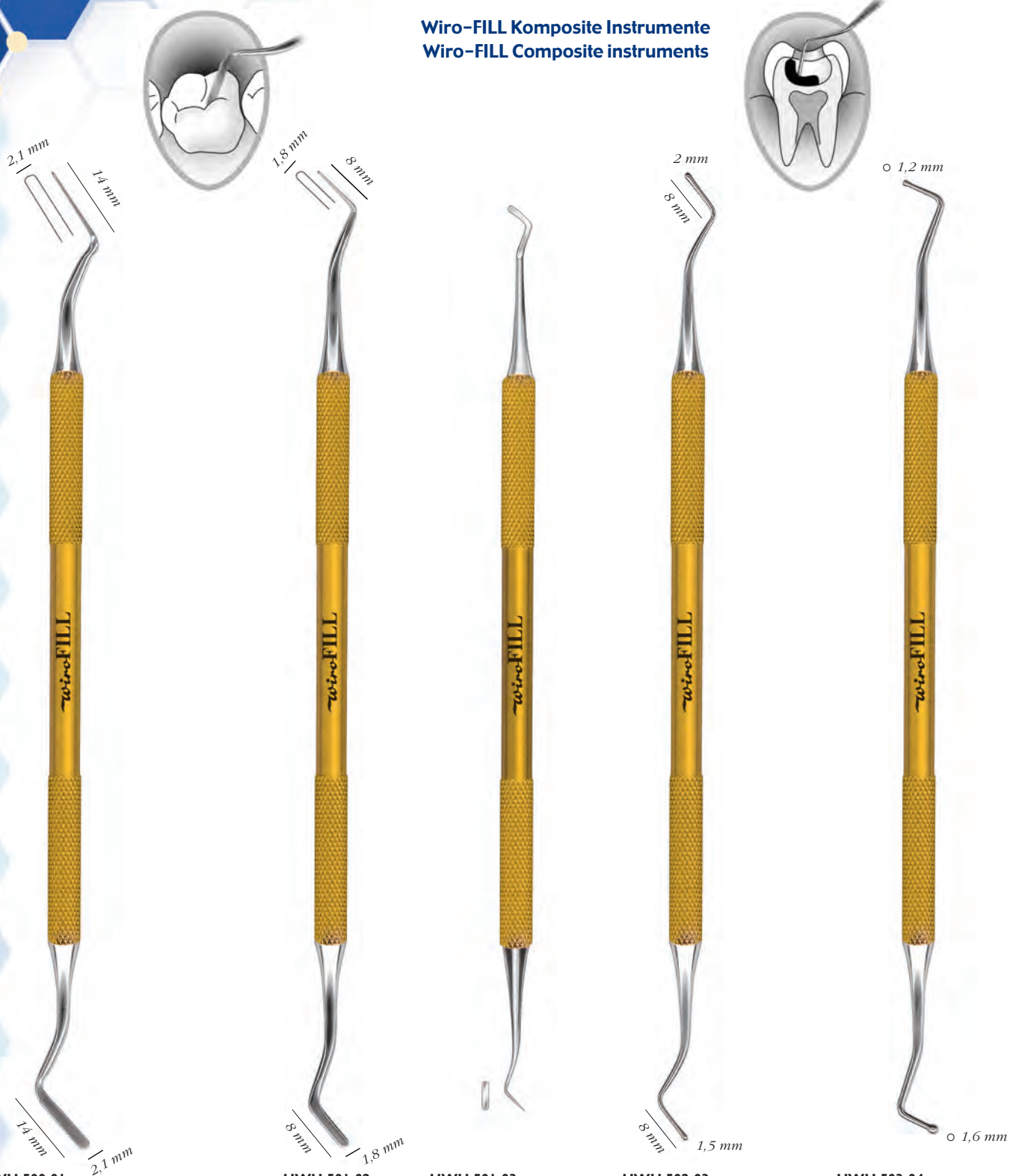

**HWH 500-01**

Doppelendiger Wiro-FILL Komposite-Spatel für mehrere Anwendungen. Die flexiblen Arbeitsenden sind entgegengesetzt ausgerichtet und ermöglichen ein leichteres Bearbeiten mit Komposite-Materialien bei der Applikation in die Kavität durch Schaffung einer besseren Einsicht in den Arbeitsbereich.

Double-ended Wiro-FILL composite-spatula for various applications. The flexible working ends are align opposite and enable an easier preparation with composite-materials when applying into the cavity, by giving a better view into the operating area.

CE

**HWH 501-02**

Doppelendiger Wiro-FILL Komposite-Mikro-Spatel für die Endbearbeitung der Kavität.

Double-ended Wiro-FILL composite micro spatula for the finishing works of the cavity.

CE

**HWH 501-03**

Der birnenförmige Wiro-FILL Komposite-Stopfer erleichtert Ihre Arbeit beim Verdichten des Komposite-Materials in der Kavität.

The pear-shaped Wiro-FILL composite-condenser facilitates your work when condensing the composite-material inside the cavity.

CE

**HWH 502-03**

**HWH 503-04**

Der Wiro-FILL Komposite-Kugelstopfer mit Contrawinkel sorgt für eine optimale Verdichtung der Komposite in der Kavität.

The ball-shaped Wiro-FILL composite-plunger with contra angle provides an optimal condensation of the composites inside the cavity.

CE

Alle mit CE gekennzeichneten Produkte sind Medizinprodukte. | All products marked with CE are medical devices.



**Wiro-FILL Instrumente** sind ausgesuchte Komposite-Instrumente, die eine besondere Hochglanzpolitur aufweisen. Sie lassen keine Adhäsion der Komposite am Instrument zu und ermöglichen dadurch eine wesentlich bessere Verarbeitung.

**Wiro-FILL instruments** are well-chosen composite instruments, which show a special high-gloss polish. They do not allow any adhesion of the composites on the instrument and enable you of a much better processing of the composite.

**HWH 504-05**

Der Wiro-FILL Komposite-Planstopfer mit glatten Arbeitsenden dient einer dichten Applikation im Kavitätenboden.

The Wiro-FILL composite-condenser with flat working ends is helpful for a dense application in the cavity base.

CE

**HWH 505-06**

Der Wiro-FILL Komposite-Planstopfer mit trompetenförmige Arbeitsenden dient einer dichten Applikation, er entfernt mühelos und schnell überschüssiges Material.

The Wiro-FILL composite-condenser with trumpet-shape working ends is helpful for a dense application, it removes easily and fast excess material.

CE

**HWH 506-07**

Das Wiro-FILL Komposite-Kondensier- und Modellierinstrument mit konischen Arbeitsenden eignet sich hervorragend zum Modellieren und Verdichten, insbesondere am Rande der Kavität.

The Wiro-FILL composite condenser and modelling instrument with cone-shaped working ends is ideal for modelling and condensation, especially on the cavity edges.

CE

**HWH 507-08**

Das Wiro-FILL Komposite-Modellierinstrument mit kegelförmigen Arbeitsenden zur genauen Gestaltung der Höcker und Ausarbeitung der Fissuren.

The Wiro-FILL composite modelling instrument with conical working ends for an exact shaping of the cusps and moulding of the fissures.

CE

**HWH 508-09**

Das Wiro-FILL Komposite-Modellierinstrument mit kegelförmigen Arbeitsenden zur genauen Gestaltung der Hügel und Ausarbeitung der Fissuren.

The Wiro-FILL composite modelling instrument with conical working ends for an exact shaping of the cusps and moulding of the fissures.

CE

Alle mit CE gekennzeichneten Produkte sind Medizinprodukte. | All products marked with CE are medical devices.

**Konservierende Behandlung**  
**Conservative treatment**

**Wiro-FILL Komposite Instrumente**  
**Wiro-FILL Composite instruments**

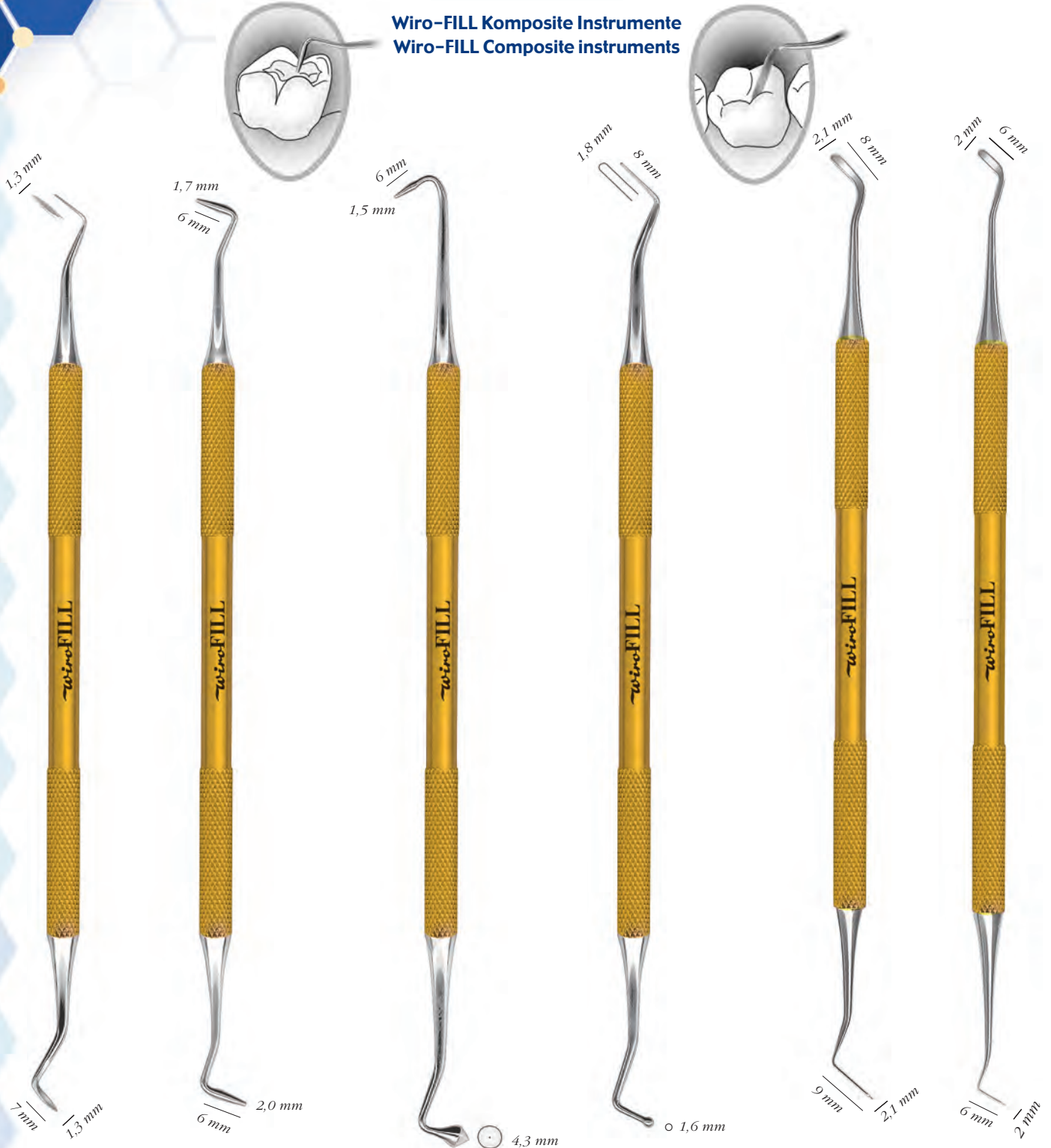

**HWH 509-10**

Das Wiro-FILL Komposite-Schnittinstrument eignet sich ideal zur Beseitigung von überschüssigem Material.

The Wiro-FILL composite carving instrument is ideal for taking off excess material.

CE

**HWH 510-11**

Das Wiro-FILL Komposite-Brünier- und Modellierinstrument mit zulaufenden Arbeitsenden und leicht abgerundeten Spitzen zur Anpassung der Komposite an den Kavitätenrändern.

The Wiro-FILL composite instrument for burnishing and modelling with tapered working ends and slightly rounded tips for adapting the composite material to the cavity edges

CE

**HWH 511-12**

Das Wiro-FILL Komposite-Modellierinstrument mit spitzer zulaufenden Arbeitsenden zum Modellieren der feinen okklusalen Ebenen von Molaren und Prämolaren.

The Wiro-FILL composite modelling instrument with more tapered working ends for carving the fine occlusal surfaces of the molars and premolars.

CE

**HWH 512-00.**

Doppelendiges Wiro-FILL Instrument - auf der einen Seite ein Spatel und auf der anderen Seite ein Kugelstopfer:

Double-ended Wiro-Fill instrument - at the one end a spatula and at the other side a plugger.

CE

**HWH 513-01**

Graziler Wiro-FILL Komposite-Spatel für alle Anwendungen

CE

Delicate Wiro-FILL composite spatula for all applications.

**HWH 513-02**

CE

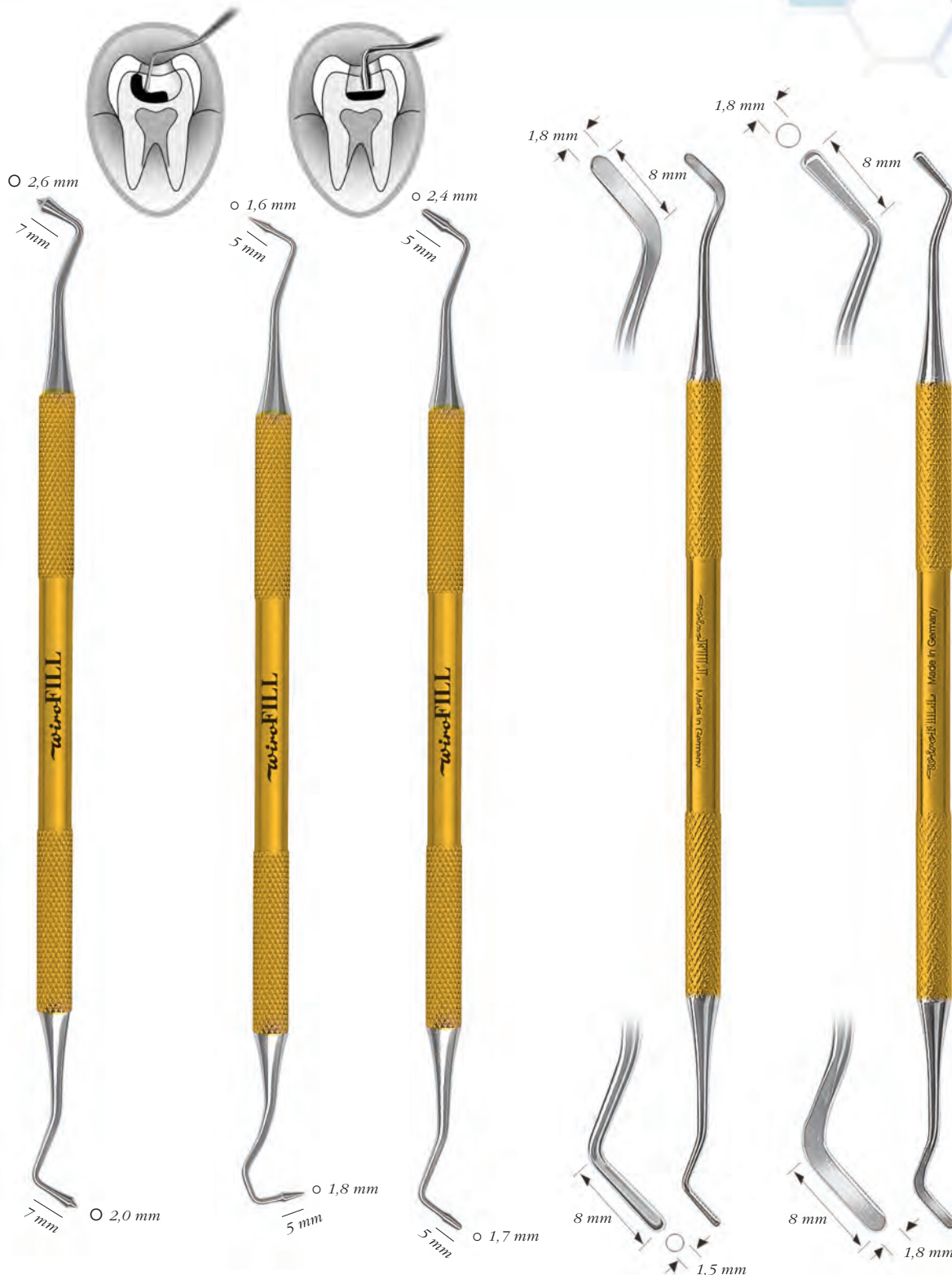

**Wiro-FILL Instrumente** sind ausgesuchte Komposite-Instrumente, die eine besondere Hochglanzpolitur aufweisen. Sie lassen keine Adhäsion der Komposite am Instrument zu und ermöglichen dadurch eine wesentlich bessere Verarbeitung.

**Wiro-FILL instruments** are well-chosen composite instruments, which show a special high-gloss polish. They do not allow any adhesion of the composites on the instrument and enable you of a much better processing of the composite.

**HWH 513-03**

Graziles Wiro-FILL Komposite-Modellierinstrument zum Anlegen von Zentralfissuren. Durch die konkave Form wird die Gestaltung der konvexen Wülste erleichtert.

Delicate Wiro-FILL composite modelling instrument for designing fissures. The concave shape facilitates the forming of convex pads.

CE

**HWH 513-04**

Graziles Wiro-FILL Komposite-Spezialinstrument zum Ausmodellieren sehr feiner okklusaler Strukturen.

Special delicate Wiro-FILL composite instrument for carving very fine occlusal surfaces.

CE

**HWH 513-05**

Graziles Wiro-FILL Komposite-Modellierinstrument mit abgerundeten Kegeln zur okklusalen Ausarbeitung im Seitenzahnbereich.

Delicate Wiro-FILL composite modelling instrument with rounded cones for forming occlusal surfaces in molar and premolar teeth.

CE

**HWH 514-01**

Spatel / birnenförmiger Stopfer  
Spatula / Pear-shaped condense

CE

**HWH 514-02**

Spatel / birnenförmiger Stopfer  
Spatula / Pear-shaped condenser

CE

Alle mit CE gekennzeichneten Produkte sind Medizinprodukte. | All products marked with CE are medical devices.



**MasterLine Wiro-FILL Instrumente** sind ausgesuchte Komposite-Instrumente, die eine besondere Hochglanzpolitur aufweisen.

Sie lassen keine Adhäsion der Komposite am Instrument zu und ermöglichen dadurch eine wesentlich bessere Verarbeitung.

**MasterLine Wiro-FILL instruments** are well-chosen composite instruments, which show a special high-gloss polish. They do not allow any adhesion of the composites on the instrument and enable you of a much better processing of the composite.



**HWH 520-01  
Hammacher**

Doppelendiger Wiro-FILL Komposite-Spatel für mehrere Anwendungen. Die flexiblen Arbeitsenden sind entgegengesetzt ausgerichtet und ermöglichen ein leichteres Bearbeiten mit Komposite-Materialien bei der Applikation in die Kavität durch Schaffung einer besseren Einsicht in den Arbeitsbereich.

Double-ended Wiro-FILL composite-spatula for various applications. The flexible working ends are align opposite and enable an easier preparation with composite-materials when applying into the cavity, by giving a better view into the operating area.

CE

**HWH 521-02  
Hammacher**

**HWH 521-03  
Hammacher**

Doppelendiger Wiro-FILL Komposite-Mikro-Spatel für die Endbearbeitung der Kavität.

Double-ended Wiro-FILL composite micro spatula for the finishing works of the cavity

CE

**HWH 522-03  
Hammacher**

Der birnenförmige Wiro-FILL Komposite-Stopfer erleichtert Ihre Arbeit beim Verdichten des Komposite-Materials in der Kavität.

The pear-shaped Wiro-FILL composite-condenser facilitates your work when condensing the composite-material inside the cavity.

CE

Alle mit CE gekennzeichneten Produkte sind Medizinprodukte. | All products marked with CE are medical devices.



**MasterLine Wiro-FILL Komposite Instrumente  
MasterLine Wiro-FILL Composite instruments**

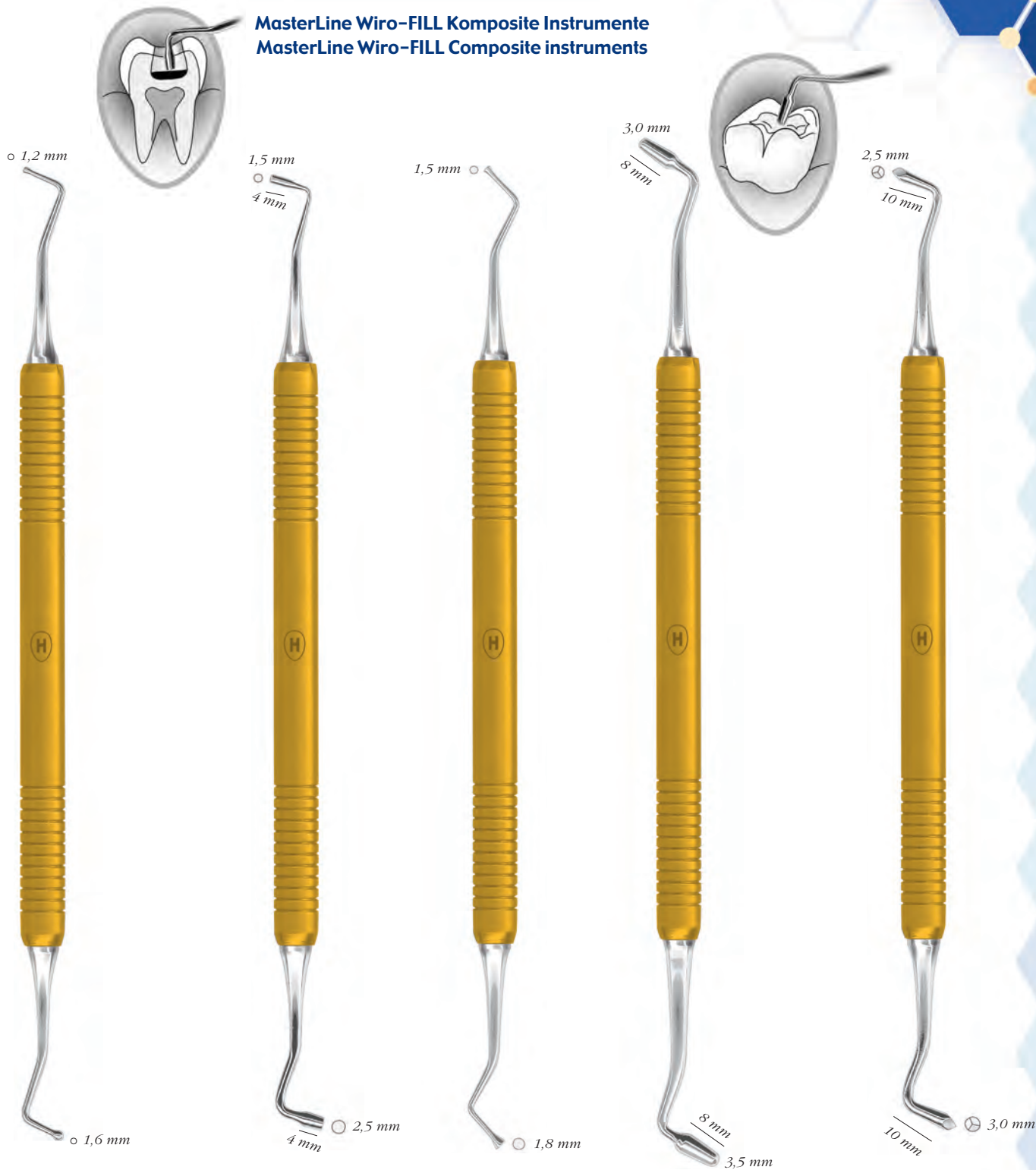

**HWH 523-04  
Hammacher**

Der Wiro-FILL Komposite-Kugelstopfer mit Contrawinkel sorgt für eine optimale Verdichtung der Komposite in der Kavität.

The ball-shaped Wiro-FILL composite-plugger with contra angle provides an optimal condensation of the composites inside the cavity.

CE

**HWH 524-05  
Hammacher**

Der Wiro-FILL Komposite-Planstopfer mit glatten Arbeitsenden dient einer dichten Applikation im Kavitätenboden.

The Wiro-FILL composite-plugger with flat working ends is helpful for a dense application in the cavity base.

CE

**HWH 525-06  
Hammacher**

Der Wiro-FILL Komposite-Planstopfer mit trompetenförmige Arbeitsenden dient einer dichten Applikation, er entfernt mühelos und schnell überschüssiges Material.

The Wiro-FILL composite-plugger with trumpet-shape working ends is helpful for a dense application, he removes easily and fast excess material.

CE

**HWH 526-07  
Hammacher**

Das Wiro-FILL Komposite-Kondensier- und Modellierinstrument mit kegelförmigen Arbeitsenden eignet sich hervorragend zum Modellieren und Verdichten, insbesondere am Rande der Kavität.

The Wiro-FILL composite condenser and modelling instrument with cone-shaped working ends is ideal for modelling and condensation, especially on the cavity edges.

CE

**HWH 527-08  
Hammacher**

Das Wiro-FILL Komposite-Modellierinstrument mit kegelförmigen Arbeitsenden zur genauen Gestaltung der Höcker und Ausarbeitung der Fissuren.

The Wiro-FILL composite modelling instrument with conical working ends for an exact shaping of the cusps and moulding of the fissures.

CE

Alle mit CE gekennzeichneten Produkte sind Medizinprodukte. | All products marked with CE are medical devices.

# Konservierende Behandlung Conservative treatment

7

## MasterLine Wiro-FILL Composite Instrumente MasterLine Wiro-FILL Composite instruments



**HWH 528-09  
Hammacher**

Das Wiro-FILL Composite-Modellierinstrument mit kegelförmigen Arbeitsenden zur genauen Gestaltung der Hügel und Ausarbeitung der Fissuren.

The Wiro-FILL composite modelling instrument with conical working ends for an exact shaping of the cusps and moulding of the fissures.

CE



**HWH 529-10  
Hammacher**

Das Wiro-FILL Composite-Schnitzinstrument eignet sich ideal zur Beseitigung von überschüssigem Material.

The Wiro-FILL composite carving instrument is ideal for taking off excess material.

CE



**HWH 530-11  
Hammacher**

Das Wiro-FILL Composite-Brünier- und Modellierinstrument mit zulaufenden Arbeitsenden und leicht abgerundeten Spitzen zur Anpassung der Composite an den Kavitätenrändern.

The Wiro-FILL composite instrument for burnishing and modelling with tapered working ends and slightly rounded tips for adapting the composite material to the cavity edges.

CE



**HWH 531-12  
Hammacher**

Das Wiro-FILL Composite-Modellierinstrument mit spitzer zulaufenden Arbeitsenden zum Modellieren der feinen okklusalen Ebenen von Molaren und Prämolaren.

The Wiro-FILL composite modelling instrument with more tapered working ends for carving the fine occlusal surfaces of the molars and premolars.

CE



**HWH 532-00**

Wiro-FILL Composite-Modellierinstrument, doppelendig, MasterLine Wiro-FILL composite-modeling instrument, double ended, Master Line

CE

Alle mit CE gekennzeichneten Produkte sind Medizinprodukte. | All products marked with CE are medical devices.



**HWH 540-01  
Hammacher**

Graziler Wiro-FILL Komposite-Spatel  
für alle Anwendungen  
Delicate Wiro-FILL composite spatula  
for all applications

CE

**HWH 541-02  
Hammacher**

CE



**HWH 542-03  
Hammacher**

Graziles Wiro-FILL Komposite-  
Modellierinstrument zum Anlegen  
von Zentralfissuren. Durch die  
konkave Form wird die Gestaltung  
der konvexen Wülste erleichtert.

Delicate Wiro-FILL composite  
modelling instrument for designing  
fissures. The concave shape facilitate  
the forming of convex pads.

CE



**HWH 543-04  
Hammacher**

Graziles Wiro-FILL Komposite-  
Spezialinstrument zum  
Ausmodellieren sehr feiner  
okklusaler Strukturen.

Special delicate Wiro-FILL  
composite instrument for carving  
very fine occlusal surfaces.

CE

**HWH 544-05  
Hammacher**

Graziles Wiro-FILL Komposite-  
Modellierinstrument mit abgerundeten Kegeln  
zur okklusalen Ausarbeitung im  
Seitenzahnbereich.

Delicate Wiro-FILL composite modelling  
instrument with rounded cones for forming  
occlusal surfaces in molar and premolar teeth.

CE



**MasterLine Wiro-FILL Instrumente**  
sind ausgesuchte Komposite-Instrumente,  
die eine besondere Hochglanzpolitur  
aufweisen.  
Sie lassen keine Adhäsion der Komposite  
am Instrument zu und ermöglichen  
dadurch eine wesentlich bessere  
Verarbeitung.

**MasterLine Wiro-FILL instruments**  
are well-chosen composite instruments,  
which show a special high-gloss polish.  
They do not allow any adhesion of the  
composites on the instrument and enable  
you of a much better processing of the  
composite.

# Konservierende Behandlung Conservative treatment

7

Der Erfolg von PPSU kann auf mehrere wichtige Leistungsmerkmale zurückgeführt werden, die diesem Polymer eigen sind:

- ✓ Hohe Hitzebeständigkeit
- ✓ Langzeitwärmestabilität
- ✓ Beständigkeit gegen längere Hitzeeinwirkung
- ✓ Breites Spektrum an chemischer Beständigkeit
- ✓ Außergewöhnliche Zähigkeit und Haltbarkeit

The success of PPSU can be attributed to several key performance attributes that are inherent to the polymer:

- ✓ High heat resistance
- ✓ Long-term thermal stability
- ✓ Resistance to prolonged hot water exposure
- ✓ Broad range of chemical resistance
- ✓ Exceptional toughness and durability



**Wiro-FILL Instrumente** sind ausgesuchte Komposite-Instrumente, die eine besondere Hochglanzpolitur aufweisen. Sie lassen keine Adhäsion der Komposite am Instrument zu und ermöglichen dadurch eine wesentlich bessere Verarbeitung.

**Wiro-FILL Instruments** are well-chosen composite instruments which show a special high-gloss polish. They do not allow any adhesion of the composites on the instrument and enable you of a much better processing of the composite.



**HSR 501-02**  
Doppelendiger Spatel mit entgegengesetzt ausgerichteten flexiblen Arbeitsenden zum leichteren Applizieren der Komposite in die Kavität.  
Double-ended spatula with oppositely directed flexible working ends for easier application of the composites in the cavity.  
CE

**HSR 501-03**  
Doppelendiger Spatel für die Endbearbeitung der Kavität.  
Double-ended spatula for the finishing of the cavity.  
CE

**HSR 502-03**  
Birnenförmiger Stopfer zum Verdichten der Komposite in der Kavität.  
Pear-shaped condenser for the condensation of the composite in the cavity.  
CE

**HSR 503-04**  
Kugelstopfer mit Kontrawinkel für eine optimale Verdichtung der Komposite in der Kavität.  
Ball-shaped condenser with contra angle for the optimum condensation of the composite in the cavity.  
CE

**HSR 508-09**  
Modellierinstrument mit kegelförmigen Arbeitsenden zur genauen Gestaltung und Ausarbeitung der Fissuren.  
Modeling instrument with cone-shaped working ends for a precise design and preparation of the fissures.  
CE

**HSR 509-10**  
Schnitzinstrument zur Beseitigung von überschüssigem Material.  
Carving instrument to remove excess material.  
CE

**HSR 512-00**  
Doppelendiges Instrument – Spatel und Kugelstopfer  
Double-ended instrument – spatula and ball-shaped condenser  
CE

**HSR 514-01**  
Doppelendiges Instrument – Spatel und birnenförmiger Stopfer  
Double-ended instrument – spatula and pear-shaped condenser  
CE

Alle mit CE gekennzeichneten Produkte sind Medizinprodukte. | All products marked with CE are medical devices.

Profi-Design Komposite Instrumente  
Profi-Design Composite instruments



**HWH 551-02**  
"Profi-Design"

Füllspatel  
Filling spatula

CE



**HWH 552-03**  
"Profi-Design"

Füllinstrument (Stopfer)  
Filling instrument (Condenser)

CE



**HWH 554-05**  
"Profi-Design"

Füllspatel, gebogen  
Filling spatula, curved

CE



**HWH 555-06**  
"Profi-Design"

Füllspatel (Biberschwanz)  
Filling spatula (Beaver tail)

CE



**HWH 556-07**  
"Profi-Design"

Modellierinstrument  
(Okklusalformer)  
Modelling instruments  
(Occlusal former)(e)

CE

PROFI-DESIGN

*wironit*

Instrumente

- |                          |                        |
|--------------------------|------------------------|
| ✔ nichtrostend           | ✔ rust resistant       |
| ✔ antimagnetisch         | ✔ anti-magnetic        |
| ✔ säurebeständig         | ✔ acid resistant       |
| ✔ formschön              | ✔ beautifully designed |
| ✔ leicht in der Hand     | ✔ light in the hand    |
| ✔ von langer Lebensdauer | ✔ unlimited durability |

**Instrumente für plastische Füllungen**  
**Plastic filling instruments**

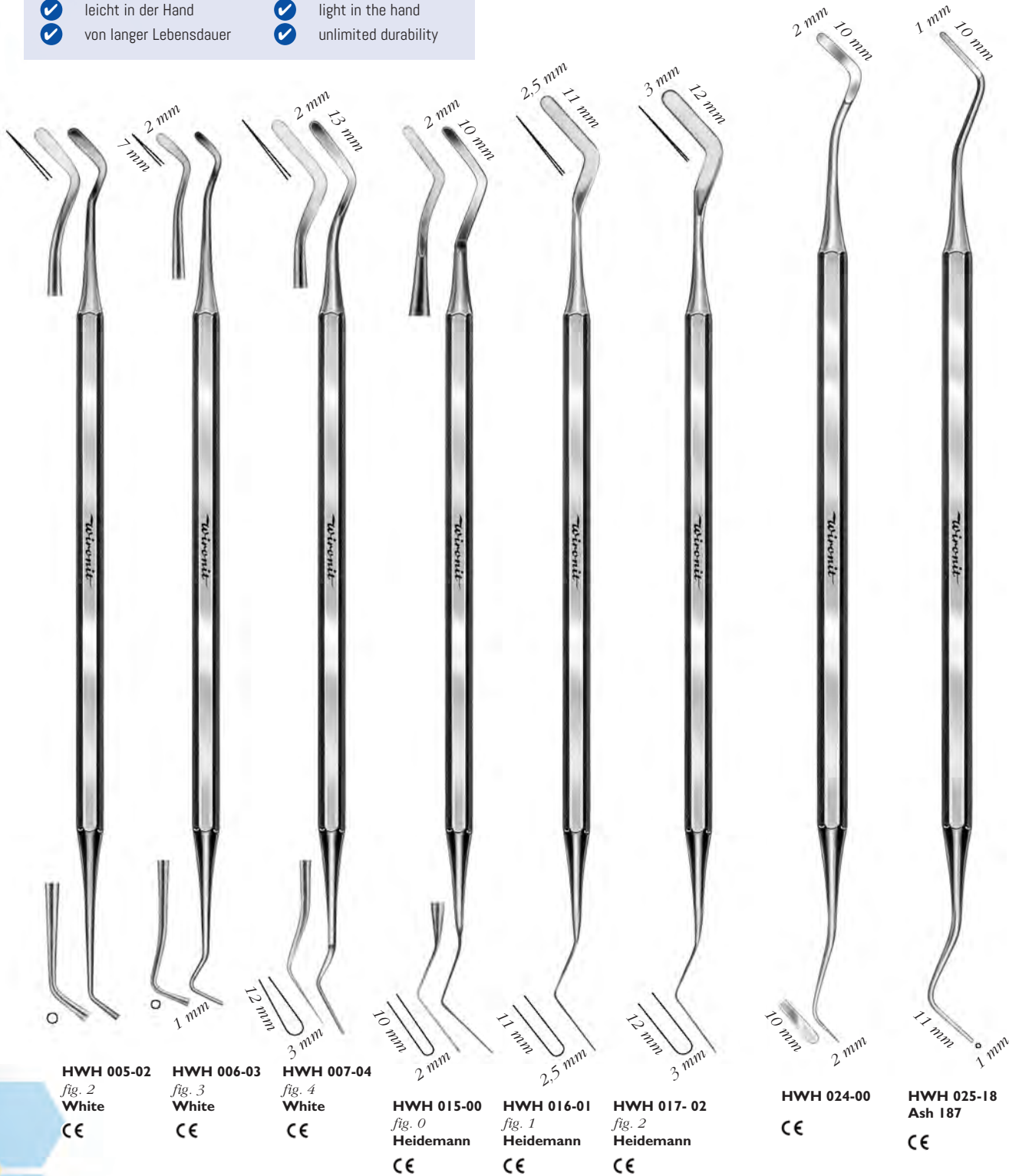

Instrumente für plastische Füllungen  
Plastic filling instruments

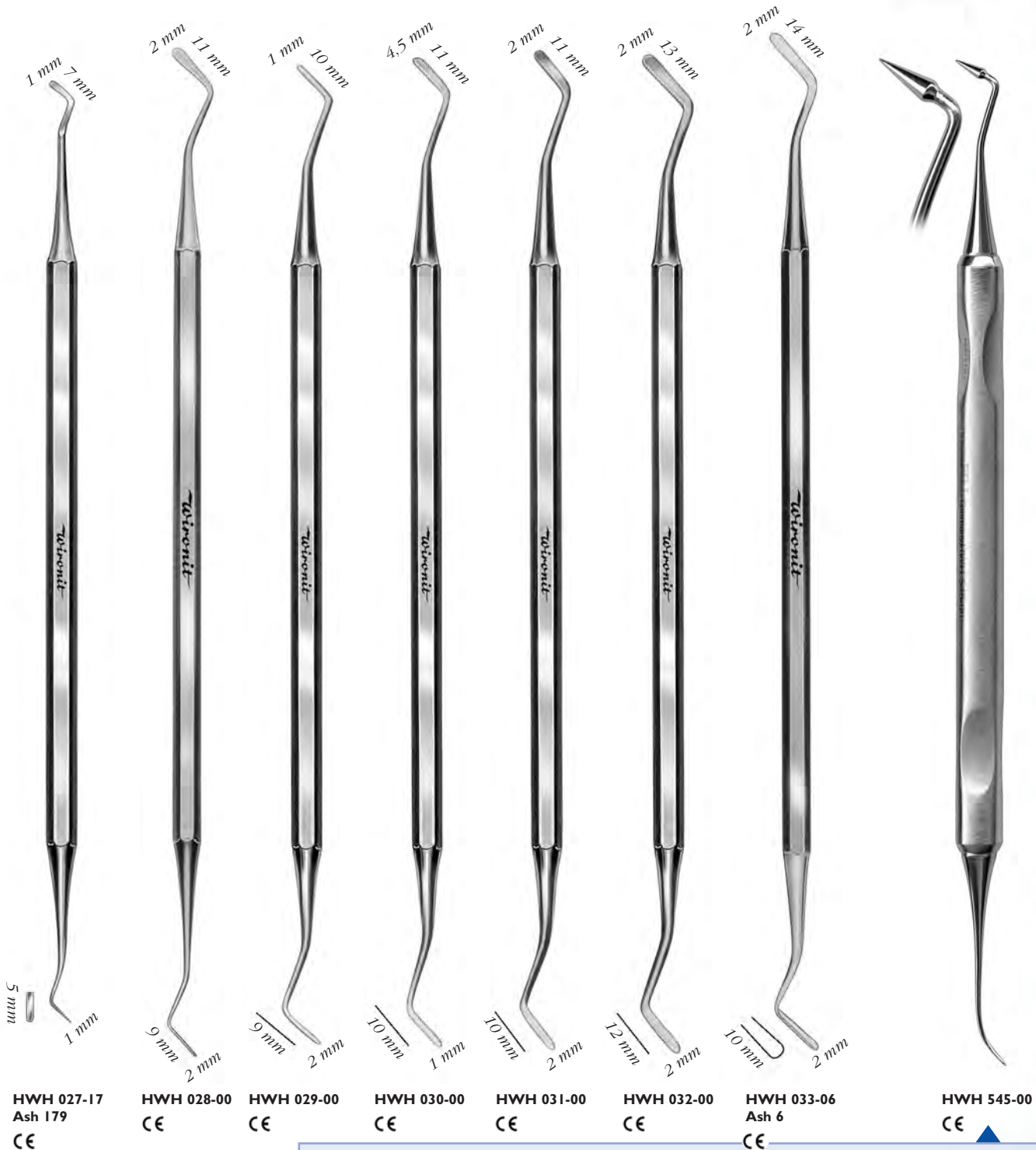

**Modellierinstrument mit extrem scharfen Spitzen**

Die konische Spitze ist perfekt für das Imitieren der Anatomie des Okklusalbereichs eines posterioren Zahns mit nur einem Instrument geeignet. Die feine sondenförmige Spitze ist optimal, um Fissuren und Mamelons zu modellieren sowie für die Applikation von Charakterisierungsfarben und Versiegelungsmitteln. Die Flexibilität des Instruments ermöglicht eine sanfte Sondierung und das Entfernen von möglichen Überresten von Klebharzen auf den Zahnoberflächen.

**Modelling instrument with extremely sharp tips**

The conical tip is perfect for imitating the anatomy of the occlusal region of a posterior tooth with only one instrument. The fine probe-shaped tip is ideal for modelling fissures and mamelons as well as for the application of characterization colours and sealants. The flexibility of the instrument allows for gentle probing and the removal of possible remnants of adhesive resins on the tooth surfaces.

# Konservierende Behandlung Conservative treatment

*wironit*

Instrumente

- |                          |                        |
|--------------------------|------------------------|
| ✔ nichtrostend           | ✔ rust resistant       |
| ✔ antimagnetisch         | ✔ anti-magnetic        |
| ✔ säurebeständig         | ✔ acid resistant       |
| ✔ formschön              | ✔ beautifully designed |
| ✔ leicht in der Hand     | ✔ light in the hand    |
| ✔ von langer Lebensdauer | ✔ unlimited durability |

## Instrumente für plastische Füllungen mit Contrawinkel Plastic filling instruments with contra angle



**HWH 040-00**  
fig. 0  
Heidemann  
CE

**HWH 041-01**  
fig. 1  
Heidemann  
CE

**HWH 042-02**  
fig. 2  
Heidemann  
CE

**HWH 043-00**  
CE

**HWH 047-00**  
CE

**HWH 048-00**  
CE

**HWH 049-00**  
CE

**HWH 050-00**  
CE



**Konservierende Behandlung  
Conservative treatment**

7



**Instrumente für plastische Füllungen mit Contrawinkel  
Plastic filling instruments with contra angle**

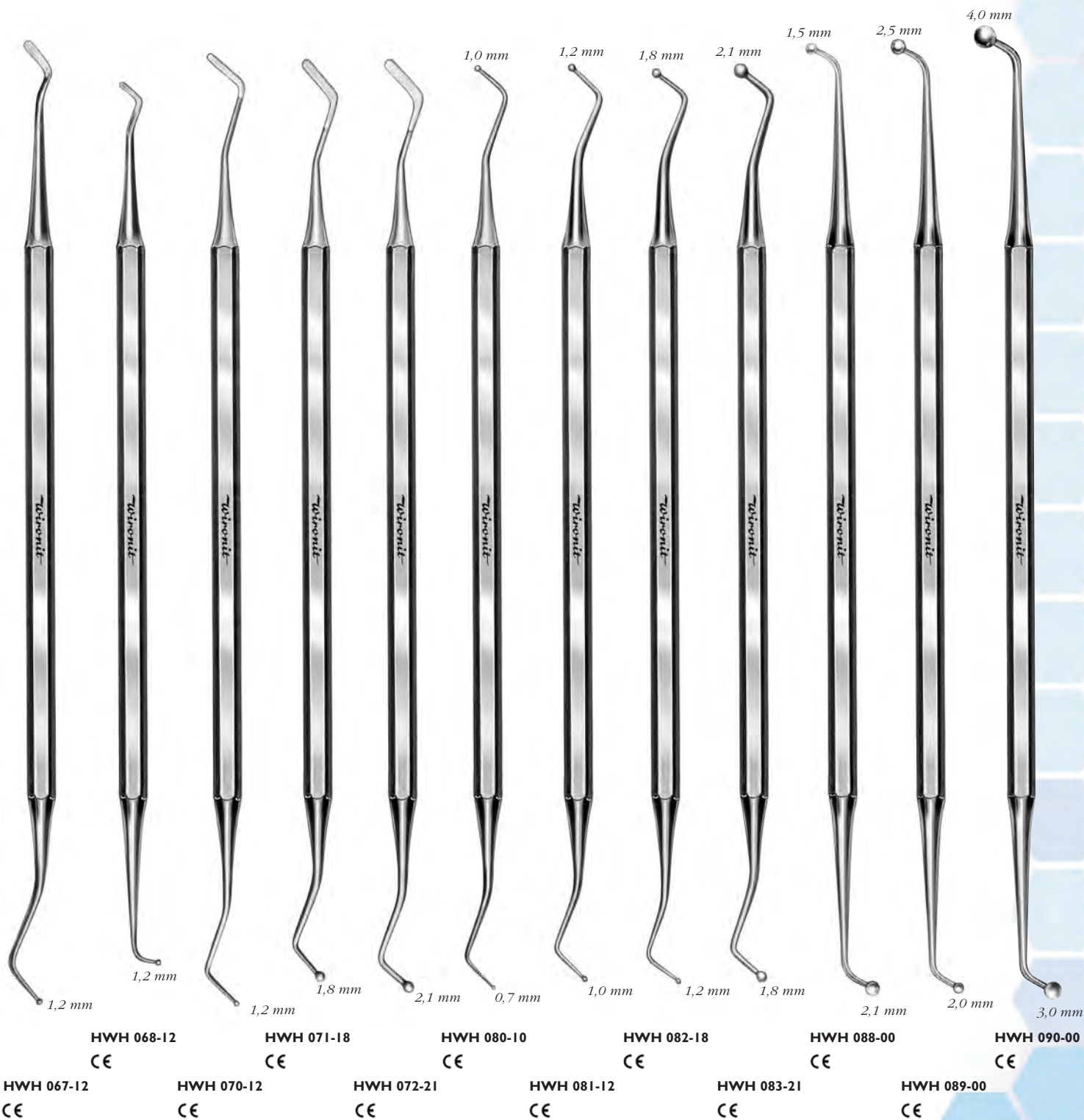

Alle mit CE gekennzeichneten Produkte sind Medizinprodukte. | All products marked with CE are medical devices.

## Konservierende Behandlung Conservative treatment

### Instrumente für plastische Füllungen, abgewinkelt Plastic filling instruments, angled

Der Erfolg von PPSU kann auf mehrere wichtige Leistungsmerkmale zurückgeführt werden, die diesem Polymer eigen sind:

- ✓ Hohe Hitzebeständigkeit
- ✓ Langzeitwärmestabilität
- ✓ Beständigkeit gegen längere Hitzeeinwirkung
- ✓ Breites Spektrum an chemischer Beständigkeit
- ✓ Außergewöhnliche Zähigkeit und Haltbarkeit

The success of PPSU can be attributed to several key performance attributes that are inherent to the polymer:

- ✓ High heat resistance
- ✓ Long-term thermal stability
- ✓ Resistance to prolonged hot water exposure
- ✓ Broad range of chemical resistance
- ✓ Exceptional toughness and durability

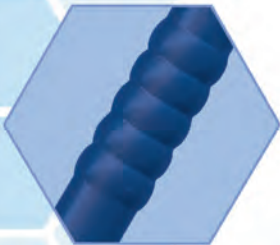

Solingen



**HSR 015-00**  
Heidemann  
fig. 0

CE

**HSR 016-01**  
Heidemann  
fig. 1

CE

**HSR 017-02**  
Heidemann  
fig. 2

CE

Instrumente für plastische Füllungen mit PPSU-Griff, sterilisierbar  
Plastic filling instruments with PPSU handle, sterilizable

Alle mit CE gekennzeichneten Produkte sind Medizinprodukte. | All products marked with CE are medical devices.

**Instrumente für plastische Füllungen mit Contrawinkel**  
**Plastic filling instruments with contra angle**

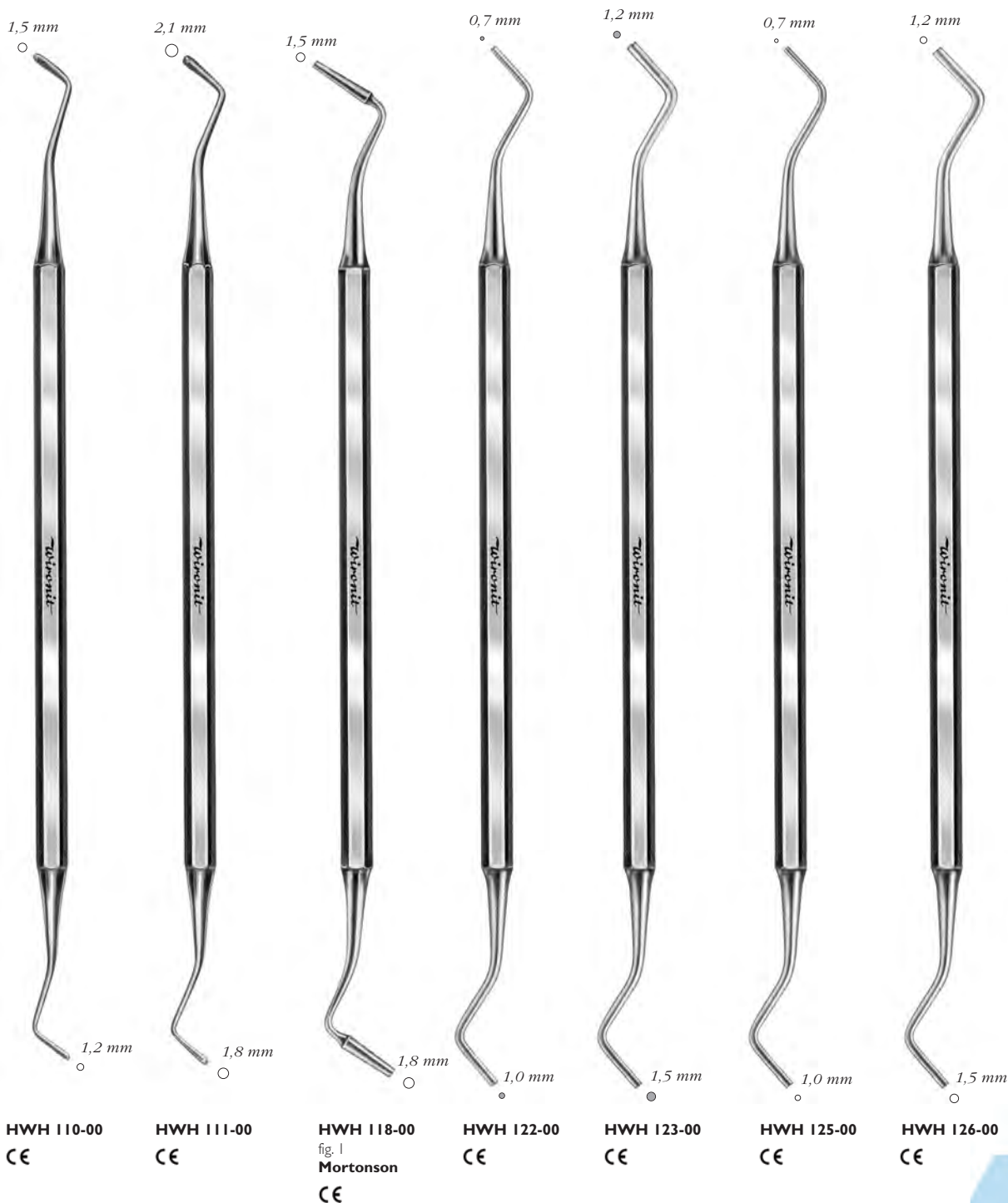

### Instrumente für plastische Füllungen

#### Plastic filling instruments

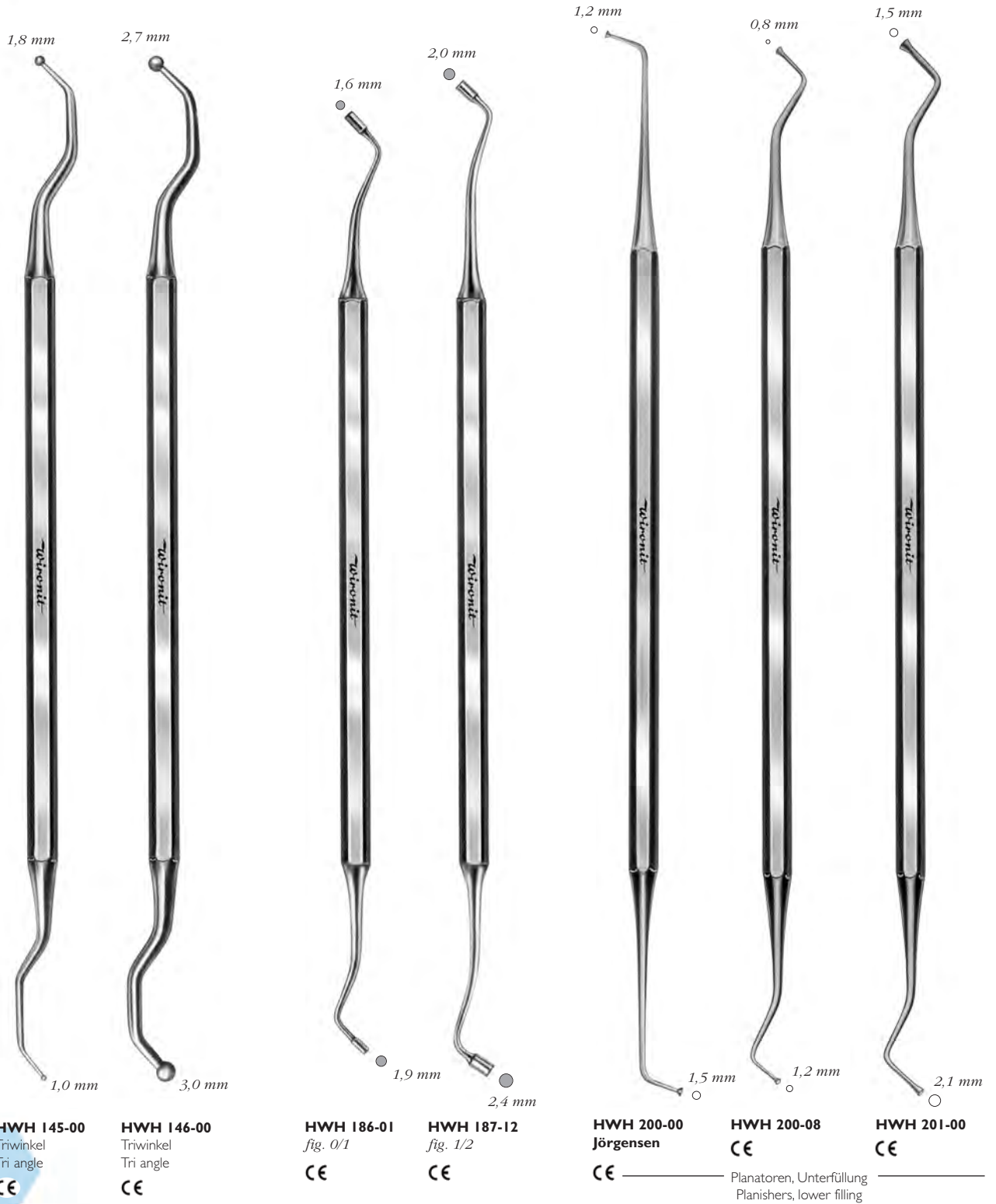

Zum Applizieren von Medikamenten, Auskleiden von Kavitäten  
For applying medicaments, lining of cavities

**Instrumente für plastische Füllungen**  
**Plastic filling instruments**



**HWH 202-00**  
Dycal-Instrumente  
Dycal instruments  
CE

**HWH 203-00**  
Dycal-Instrumente  
Dycal instruments  
CE

**HWH 204-00**  
Dycal-Instrumente  
Dycal instruments  
CE

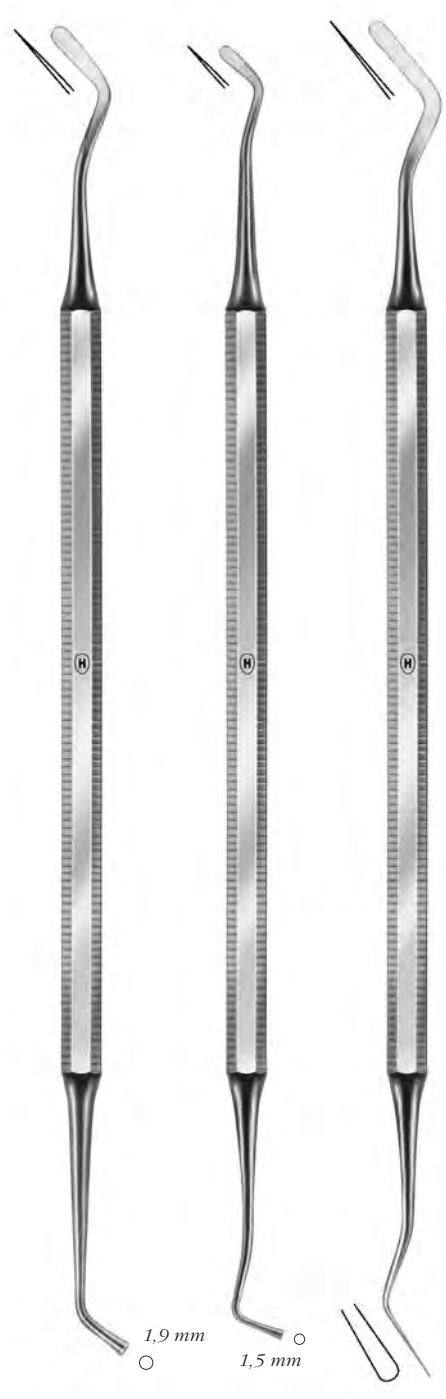

**HSH 004-02**  
fig. 2  
White  
CE

**HSH 005-03**  
fig. 3  
White  
CE

**HSH 006-04**  
fig. 4  
White  
CE

### Instrumente für plastische Füllungen

#### Plastic filling instruments

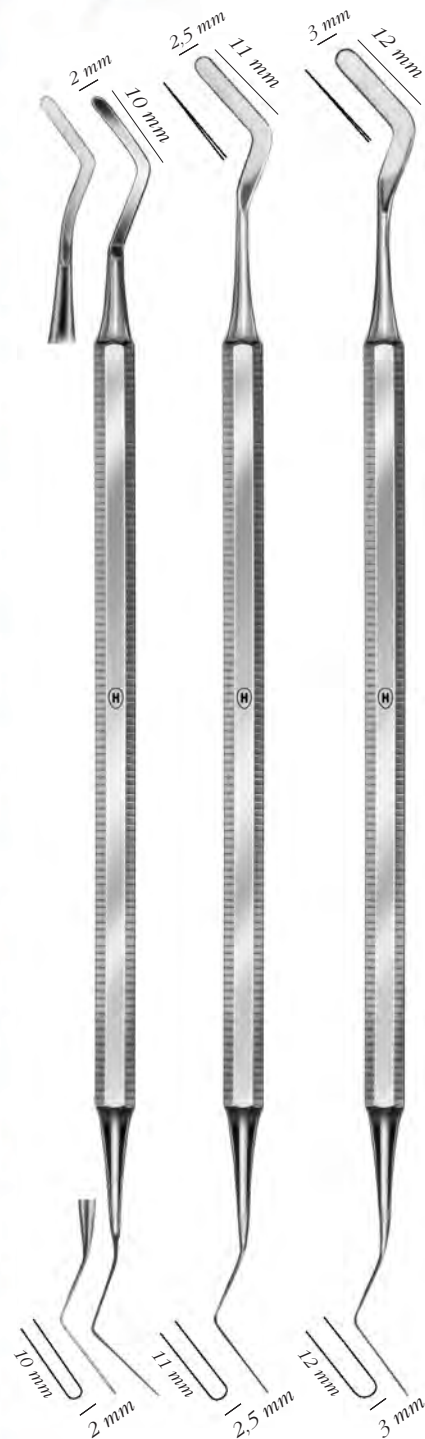

**HSH 010-00**  
fig. 0  
**Heidemann**  
CE

**HSH 011-01**  
fig. 1  
**Heidemann**  
CE

**HSH 012-02**  
fig. 2  
**Heidemann**  
CE



**HSH 017-12**  
**Helios**  
Molarstopfer  
Molar plugger  
CE



**HSH 021-01**  
fig. 1  
**Hollenback**  
CE



**HSH 027-01**  
fig. 0/1  
**Black**  
CE



**HSH 026-06**

**Platzierinstrumente**  
zum Platzieren von  
Unterfüllungsmaterial und  
Schutzlack bei  
Kavitätenpräparationen

**Placement instruments**  
used to place base or liner within  
cavity preparations

CE

**Instrumente für plastische Füllungen**  
**Plastic filling instruments**

**Amalgampistolen / -träger**  
**Amalgam guns / carrier**

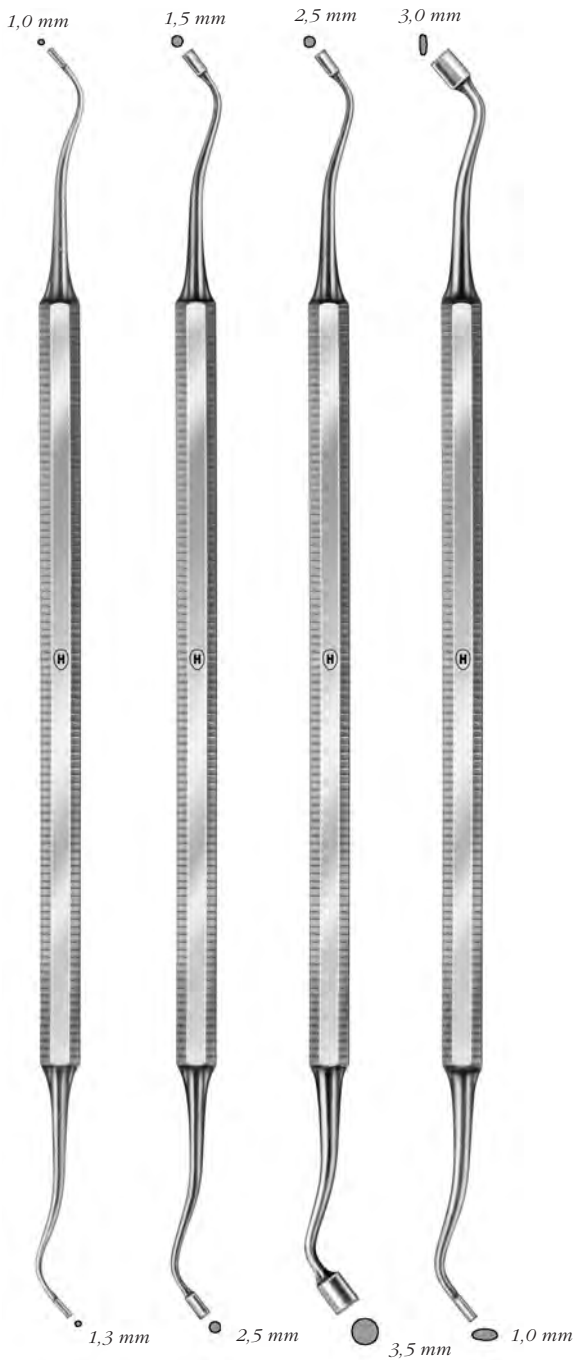

**HSH 029-00** fig. 00/0 **Black** **CE**  
**HSH 029-01** fig. 1/2 **Black** **CE**  
**HSH 029-02** fig. 2/3 **Black** **CE**  
**HSH 029-04** fig. 4/5 **Black** **CE**



**HSH 074-00**  
Ersatzmetallspitze für  
HSH 071-00 und HSH 073-00  
Spare metal tips for  
HSH 071-00 and HSH 073-00  
**CE**

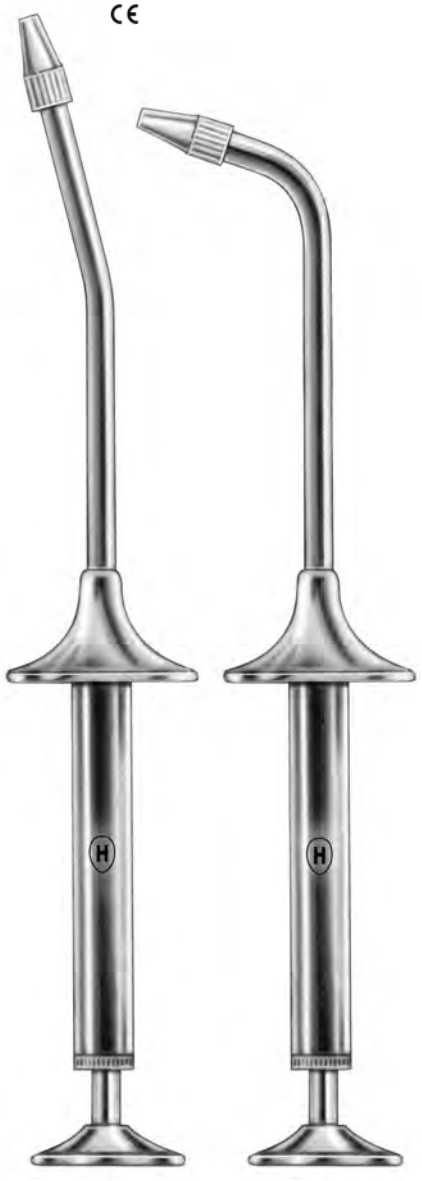

**HSH 071-00**  
150 mm  
mit Metall-Spitze  
with metal tip  
**CE**  
**HSH 073-00**  
130 mm  
mit Metall-Spitze  
with metal tip  
**CE**



**HSH 081-00**  
**Ivory**  
220 mm  
Amalgamträger  
Amalgam carrier  
**CE**

Alle mit CE gekennzeichneten Produkte sind Medizinprodukte. | All products marked with CE are medical devices.

### Amalgaminstrumente

### Amalgam instruments

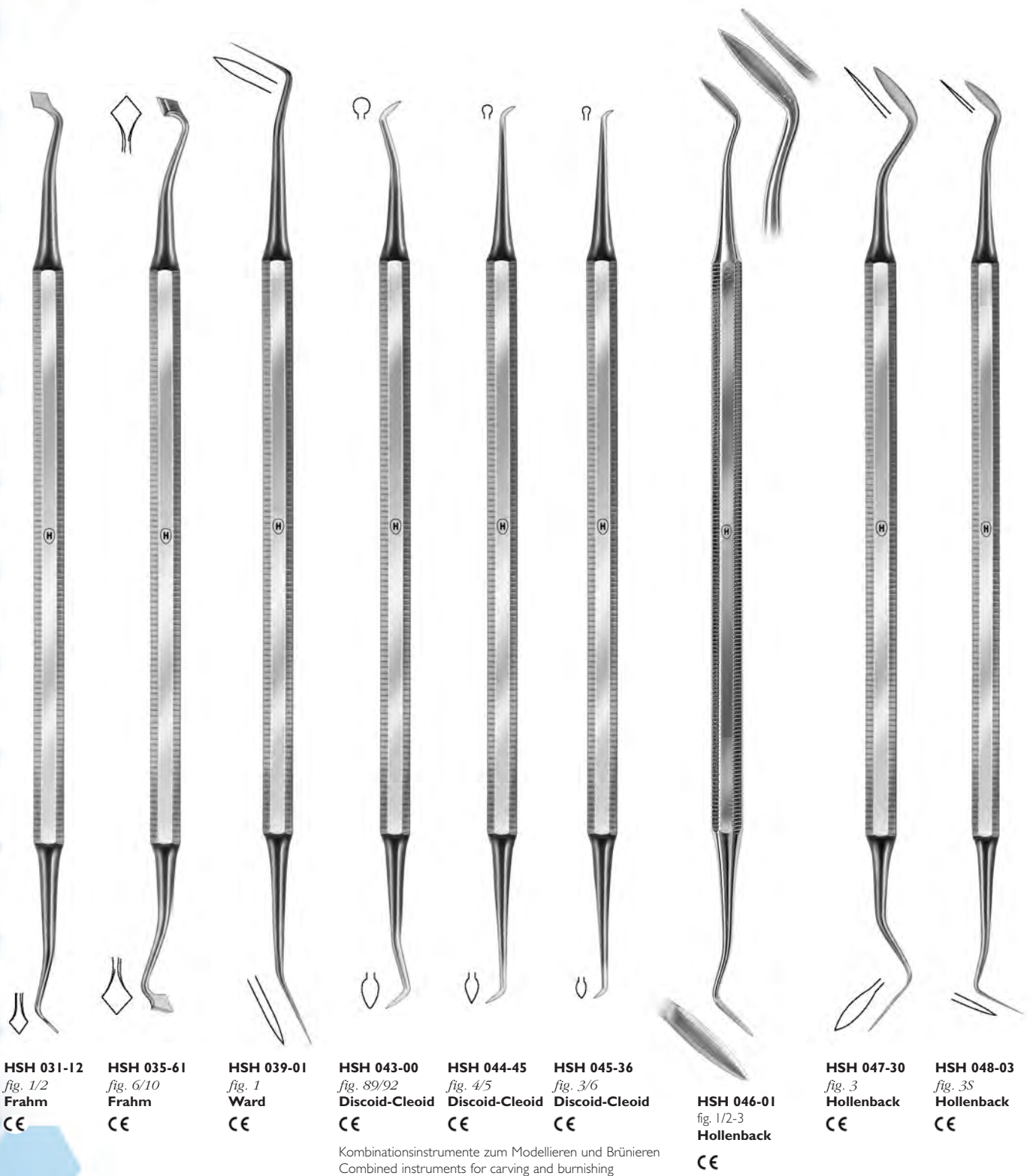

Alle mit CE gekennzeichneten Produkte sind Medizinprodukte. | All products marked with CE are medical devices.



**Amalgaminstrumente  
Amalgam instruments**

**Instrumente zur anatomischen  
Gestaltung von Füllungen  
Finishing instruments**

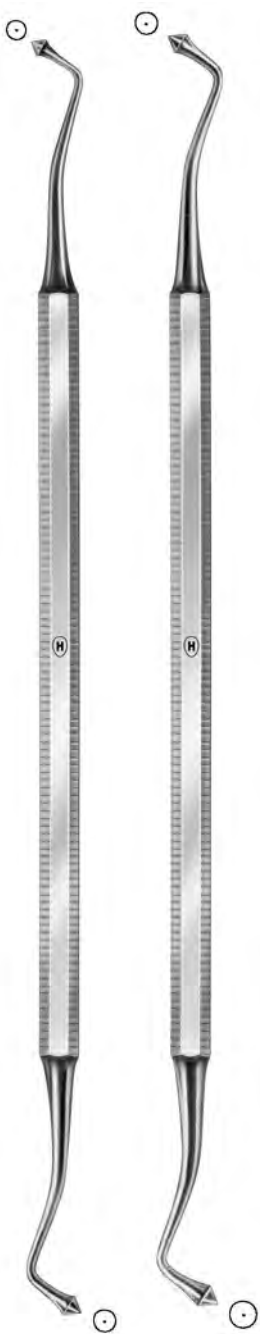

**HSH 053-21**  
fig. 21  
**Westcott**  
Kegelförmig  
conical  
CE  
Amalgam Schnitzinstrumente  
Amalgam trimmers

**HSH 054-21**  
fig. 21B  
**Westcott**  
Kegelförmig  
conical  
CE  
Amalgam Schnitzinstrumente  
Amalgam trimmers

**HSH 055-00**  
**Discoid / Cleoid**  
CE  
Amalgam Schnitzinstrumente  
Amalgam trimmers

**HSH 057-01**  
CE  
**Interproximal carver / Schnitzinstrument**  
• zum Schnitzen und Gestalten und zum Abnehmen überschüssigen Materials, sehr dünnes und feines Arbeitsende, ideal zum Schnitzen in approximalen Bereichen  
**Interproximal carver**  
• used to carve anatomical features and trim excess materials, extremely thin and flexible blade, ideal for interproximal contouring

**HSH 056-00**  
Amalgam-Schnitzinstrument  
Amalgam trimmers  
CE  
Amalgam Schnitzinstrumente  
Amalgam trimmers

**HSH 062-31**  
fig. 31  
**White**  
CE  
Instrumente zur anatomischen Gestaltung von Füllungen  
Finishing instruments

**HSH 063-32**  
fig. 32  
**White**  
CE  
Instrumente zur anatomischen Gestaltung von Füllungen  
Finishing instruments

Das leicht scheibenförmige DISCOID-Arbeitsende dient zur Beseitigung von überschüssigem Material. Die etwas breiter ausgearbeitete Fläche verhindert das unbeabsichtigte Herausnehmen von zu viel Füllungsmaterial. Das spitz zulaufende CLEOID-Arbeitsende eignet sich hervorragend zum Modellieren und Schnitzen von Fissuren und Mulden. The slightly disk-shaped DISCOID working end serves for the removal of surplus material. The more broadly surface prevents

Alle mit CE gekennzeichneten Produkte sind Medizinprodukte. | All products marked with CE are medical devices.

# Konservierende Behandlung Conservative treatment

Instrumente zur anatomischen  
Gestaltung von Füllungen  
Finishing instruments

Spezielle Instrumente  
Special instruments

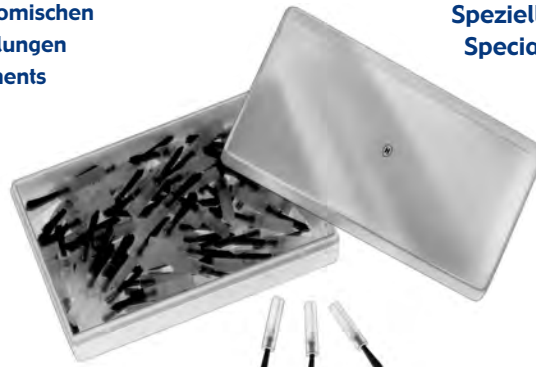

Geriefte Hilfsinstrumente zum leichten  
Anlegen der Retraktionsfäden und -Ringe.  
Serrated auxiliary instruments for easy  
fitting of retraction threads and rings.

**HWH 254-00**  
Einwegpinsel für HWH 252-01 und HWH 253-02  
Disposable brush for HWH 252-01 and HWH 253-02  
*in Packungen zu 100 Stück*  
*in packages of 100 pcs.*

CE



Füllungen  
FILLINGS



**HSH 066-27**  
*fig. 27/29*

CE



**HWH 067-28**  
*fig. 28/29*

CE



**HWH 252-01**  
**Hermkens**  
Pinselhalter, einendig  
Brushholder, single end

CE



**HWH 253-02**  
**Hermkens**  
Pinselhalter, doppelendig  
Brushholder, double-end

CE



**HSC 501-00**  
**Miller**  
150 mm  
Artikulationspapierpinzetten  
Forceps for articulating paper

CE



**HWP 007-01**  
*fig. 1*  
**Hammacher**

Retraktions-, Faden- und  
Ringe-Stopfer; gerieft  
Nicht für geflochtenen  
Draht !!

Retraction, threads and  
rings packer, serrated  
Not for braided wire !

CE

Alle mit CE gekennzeichneten Produkte sind Medizinprodukte. | All products marked with CE are medical devices.

## Konservierende Behandlung Conservative treatment

7

*wironit*

Instrumente

- |                          |                        |
|--------------------------|------------------------|
| ✓ nichtrostend           | ✓ rust resistant       |
| ✓ antimagnetisch         | ✓ anti-magnetic        |
| ✓ säurebeständig         | ✓ acid resistant       |
| ✓ formschön              | ✓ beautifully designed |
| ✓ leicht in der Hand     | ✓ light in the hand    |
| ✓ von langer Lebensdauer | ✓ unlimited durability |

### Zement- und Separierspatel Cement and separating spatulas

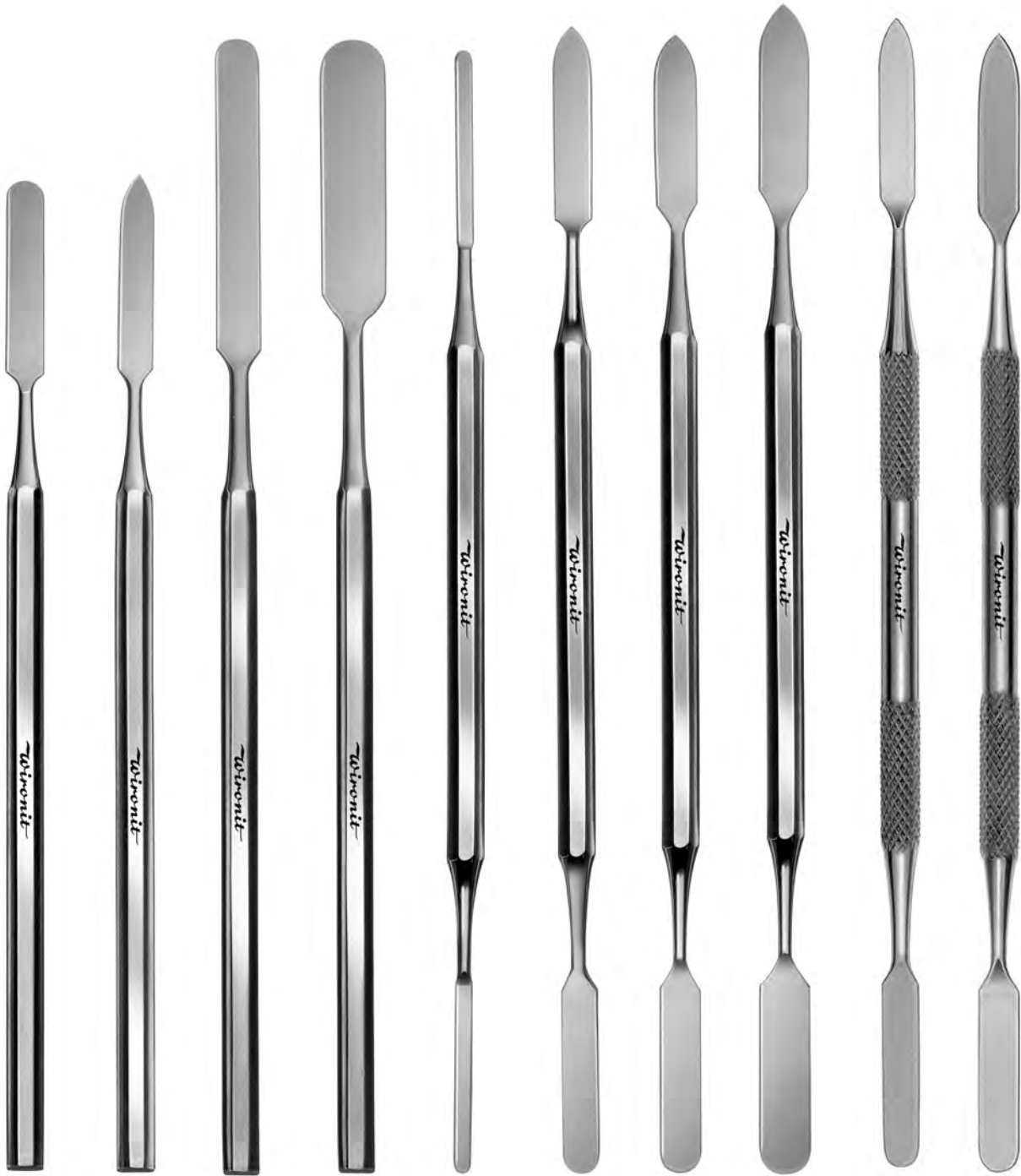

- |                   |                   |                   |                   |                                            |                   |                   |                   |                                                                               |                   |
|-------------------|-------------------|-------------------|-------------------|--------------------------------------------|-------------------|-------------------|-------------------|-------------------------------------------------------------------------------|-------------------|
| <b>HWH 217-00</b> | <b>HWH 218-00</b> | <b>HWH 220-00</b> | <b>HWH 221-00</b> | <b>HWH 225-00</b>                          | <b>HWH 226-00</b> | <b>HWH 227-00</b> | <b>HWH 228-00</b> | <b>HWH 237-00</b>                                                             | <b>HWH 239-00</b> |
| CE                | CE                | no. 324<br>CE     | no. 336<br>CE     | Separierspatel<br>Separating spatula<br>CE | CE                | CE                | CE                | Separierspatel mit Rundgriffen<br>Separating spatula with round handles<br>CE | CE                |

Alle mit CE gekennzeichneten Produkte sind Medizinprodukte. | All products marked with CE are medical devices.

### Zement- und Achatspatel

#### Cement and agate spatulas



**HSH 089-24**  
no. 24A  
CE



**HSH 096-00**  
Weston  
CE



**HSH 098-00**  
CE



**HSH 101-00**  
CE



**HSH 102-00**  
CE



**HSH 106-00**  
Achatspatel  
Spatula of agate

# Konservierende Behandlung Conservative treatment

7

## Glasplatten, Matrizenspanner + Matrizen mit runden Löchern Glass slabs, matrix retainers + matrices with round holes



**HSL 750-00**  
150 x 75 mm



**HSL 751-00**  
95 x 70 mm

**Glassplatten**  
**Glass slabs**

- ✓ können in der Spülmaschine bis max. 95°C gereinigt werden
- ✓ can be cleaned in the dishwasher up to max. 95°C

in Packungen zu 12 Bändern für Matrizenspanner  
**HSH 112-01 + HSH 113-12**  
in packages of 12 bands for matrix retainer  
**HSH 112-01 + HSH 113-12**



**HSH 112-01**  
**Ivory**  
no. 1  
Matrizenspanner ohne Backen  
Matrix retainer without shields

CE



**HSH 126-06**  
6 x 1000 x 0,05 mm  
Matrizenbänder für HSH 114-06, Metall  
Matrixbands for HSH 114-06, metal

CE



**HSH 125-05**  
5 x 1000 x 0,05 mm  
Matrizenbänder für HSH 121-05  
Matrixbands for HSH 121-05

CE

**HSH 127-07**  
7 x 1000 x 0,05 mm  
Matrizenbänder für HSH 123-07  
Matrixbands for HSH 123-07

CE



**HSH 115-01**  
fig. 1  
**Ivory**  
für Molaren  
for molars CE



**HSH 116-02**  
fig. 2  
**Ivory**  
für Molaren  
for molars CE



**HSH 117-03**  
fig. 3  
**Ivory**  
für Molaren  
for molars CE



**HSH 118-01**  
fig. 1  
**Ivory**  
für Prämolaren  
for premolars CE



**HSH 119-02**  
fig. 2  
**Ivory**  
für Prämolaren  
for premolars CE



**HSH 120-03**  
fig. 3  
**Ivory**  
für Prämolaren  
for premolars CE



**HSH 113-12**  
**Ivory**  
no. 12  
Matrizenspanner mit Backen  
Matrix retainer with shields

CE

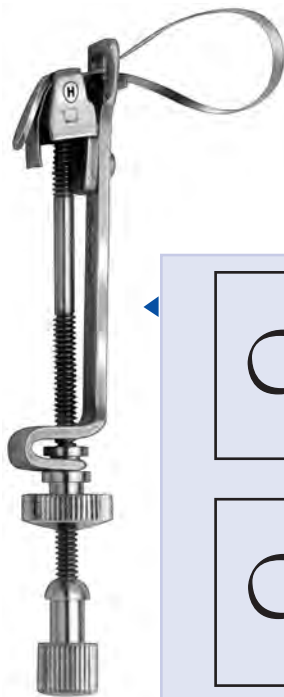

**HSH 114-06**  
6 mm  
für Metall  
for metal

CE

**HSH 114-07**  
7 mm  
für Metall  
for metal

CE

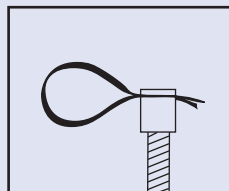
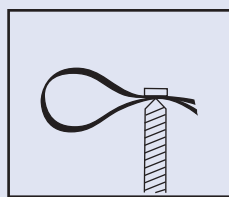

Matrizenspanner mit Schutzbügel, für  
Bänder von 6 mm oder 7 mm Breite.  
Matrix retainers with protector, for  
strips of 6 mm or 7 mm width.



**HSH 121-05**  
fig. 5  
**Ivory**  
no. 8  
Matrizenspanner für Bänder  
von 5 mm Breite  
Matrix retainers for Strips  
of 5 mm width

CE

Alle mit CE gekennzeichneten Produkte sind Medizinprodukte. | All products marked with CE are medical devices.

## Konservierende Behandlung Conservative treatment

### Matrizenspanner + Matrizen Matrix retainers + matrices

Verpackungseinheit 12 Stück  
Package of 12 bands



**HSH 128-07**

fig. 7

**Tofflemire**

für Molaren, Stärke: 0,05 mm  
for molars, thickness: 0,05 mm

CE



**HSH 129-08**

fig. 8

**Tofflemire**

für Molaren, Stärke: 0,05 mm  
for molars, thickness: 0,05 mm

CE



**HSH 130-09**

fig. 9

**Tofflemire**

für Molaren, Stärke: 0,05 mm  
for molars, thickness: 0,05 mm

CE



**HSH 131-10**

fig. 10

**Tofflemire**

für Molaren, Stärke: 0,05 mm  
for molars, thickness: 0,05 mm

CE



**HSH 132-11**

fig. 11

**Tofflemire**

für Molaren und Prämolaren, Stärke: 0,05 mm  
for molars and premolars, thickness: 0,05 mm

CE



**HSH 133-12**

fig. 12

**Tofflemire**

für Molaren und Prämolaren, Stärke: 0,05 mm  
for molars and premolars, thickness: 0,05 mm

CE



**HSH 134-13**

fig. 13

**Tofflemire**

für Molaren und Prämolaren, Stärke: 0,05 mm  
for molars and premolars, thickness: 0,05 mm

CE

Verpackungseinheit: 1 Dutzend  
Standard package: 1 dozen



**HSH 140-01**

fig. 1

**Tofflemire**

CE



**HSH 141-02**

fig. 2

**Tofflemire**

CE



**HSH 142-03**

fig. 3

**Tofflemire**

CE

#### Matrizenspanner Siqveland

selbsteinstellend - einfach zu bedienen  
und auf allen Zähnen zu verwenden - sorgt  
für vollkommene anatomische Anpassung

#### Matrix retainer Siqveland

self-adjustable - easy to operate and  
usable on all teeth - provides perfect  
anatomical adaptation

#### HSH 138-01 Siqveland

Matrizenband, schmal 5 x 85 mm  
Matrix band, narrow 5 x 85 mm

CE

#### HSH 138-05 Siqveland

Matrizenband, breit 6 x 85 mm  
Matrix band, wide 6 x 85 mm

CE

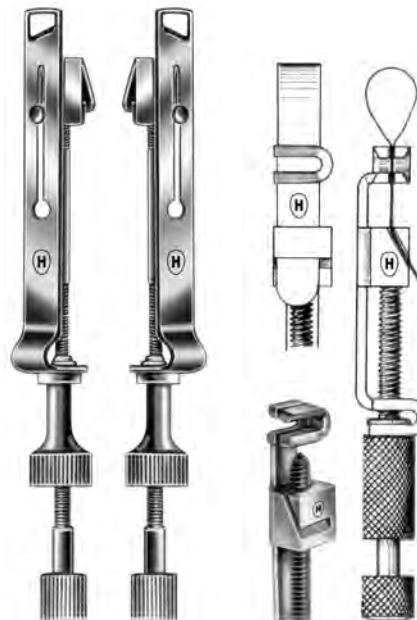

**HSH 135-00**

R, L

**Nyström**

Paar Matrizenspanner rechts  
und links für 6 mm-Bänder  
Set of matrix retainers right  
and left for 6 mm bands

CE

**HSH 136-00**

**Tofflemire-Universal**

Matrizenspanner  
Matrix retainer

CE

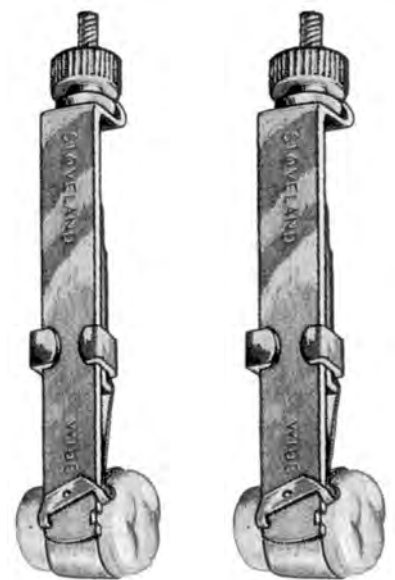

**HSH 138-00**

**Siqveland**

Matrizenspanner; schmal  
Matrix retainer; narrow

CE

**HSH 138-04**

**Siqveland**

Matrizenspanner; breit  
Matrix retainer; wide

CE

**Kofferdam-Instrumente  
Rubberdam instruments**



**HSH 148-00  
Ainsworth  
170 mm**

**Vorzüge:**

Die Kofferdam-Lochzange ermöglicht einen sauberen, regelmäßigen Einschnitt im Kofferdam. Sie ist für alle Größenanforderungen verschiedener Spannungen und Verfahren geeignet. Die Lochvorrichtung kann bei Verschleiß leicht und kostengünstig ausgetauscht werden. Leichter Druck bei der Handhabung genügt zur optimalen Anwendung. Keine Korrosionsprobleme.

**Features:**

Ability to cut dam cleanly and regularly. Copes with requirements for all sizes of clamps and techniques. When worn, punch mechanism is easily and cheaply replaced. Only light pressure need be applied for good results. No corrosion problems.



**HSH 159-00  
Ivory  
170 mm  
Kofferdam- Klammerzangen  
Rubber-dam clamp forceps**

CE

Hammacher Instrumentensätze - PROFESSIONELL - AKTUELL - UNIVERSELL  
 Hammacher sets of instruments - PROFESSIONAL - UP-TO-DATE - UNIVERSAL

### HSH 203-01

#### Kofferdam-Satz

Nr. 1, 14 teilig, im Aluminium-Tray, bestehend aus:

#### Set of rubber-dam

No. 1, 14 parts, in an Aluminium tray, consisting of:

# SET

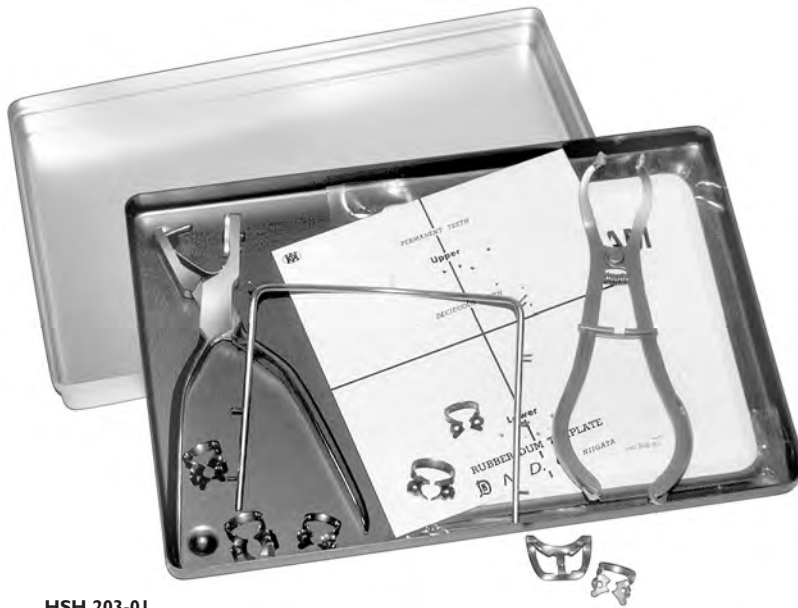

#### HSH 203-01

Kofferdam-Satz Nr. 1, 14 teilig, im Aluminium-Tray, bestehend aus:  
 Set of rubber-dam No. 1, 14 parts, in an Aluminium tray, consisting of:

CE

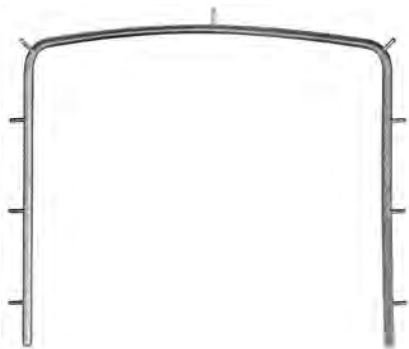

#### HSH 171-01

Kofferdam-Rahmen, für Erwachsene  
 Rubber-dam frame, for adults

CE

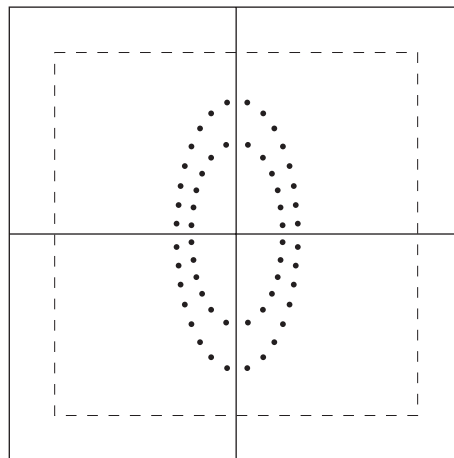

#### HSH 199-00

Kofferdam-Loch-Schablone, aus weißem Kunststoff,  
 150 x 150 mm, Auflage für präzises Lochen  
 Rubber-dam-template, from white plastic,  
 150 x 150 mm, for precise perforation

### Klammern Clamps



**HSH 210-00**  
 No. 0  
 für Prämolaren  
 for premolars  
 CE



**HSH 211-01**  
 No. 1  
 für Prämolaren  
 for premolars  
 CE



**HSH 212-02**  
 No. 2  
 für Prämolaren  
 for premolars  
 CE



**HSH 213-07**  
 No. 7  
 für Molaren  
 for molars  
 CE



**HSH 215-08**  
 No. 8  
 für Molaren  
 for molars  
 CE



**HSH 216-80**  
 No. 8A  
 für Molaren  
 for molars  
 CE



**HSH 217-14**  
 No. 14A  
 für Molaren  
 for molars  
 CE



**HSH 219-21**  
 No. 212  
 labial  
 CE



**Hammacher Instrumentensätze – PROFESSIONELL – AKTUELL – UNIVERSELL**  
**Hammacher sets of instruments – PROFESSIONAL – UP-TO-DATE – UNIVERSAL**



**HSH 148-00**  
**Ainsworth**  
170 mm  
Kofferdam-Lochzange  
Rubber-dam cutting forceps



**HSH 200-08**  
Bord für 8 Klammern, rostfrei  
Tray for 8 clamps, stainless



**HSM 260-28**  
Tray, Deckel und Boden,  
leer, 28 x 18 cm, aus Aluminium  
Tray, lid and bottom,  
empty, 28 x 18 cm, from Aluminium

**Vorzüge:**

Die Kofferdam-Lochzange ermöglicht einen sauberen, regelmäßigen Einschnitt im Kofferdam. Sie ist für alle Größenanforderungen verschiedener Spannungen und Verfahren geeignet. Die Lochvorrichtung kann bei Verschleiß leicht und kostengünstig ausgetauscht werden. Leichter Druck bei der Handhabung genügt zur optimalen Anwendung. Keine Korrosionsprobleme.

**Features:**

Ability to cut dam cleanly and regularly. Copes with requirements for all sizes of clamps and techniques. When worn, punch mechanism is easily and cheaply replaced. Only light pressure need be applied for good results. No corrosion problems.

**Produkte aus Aluminium**  
Folgende Sterilisationsmethoden sind bedenkenlos anzuwenden:

- Autoklav max. 134°, Chemiklav max. 132° oder Heißluftsterilisator max. 180°.
- Beachten Sie die Hinweise der Sterilisatorenhersteller bezüglich der Sterilisationsdauer.
- Benutzen Sie keinen Thermodesinfektor.
- Benutzen Sie kein Ultraschallbad.
- Beachten Sie genau die Vorschriften des Desinfektionshersteller; einige sind für Aluminium nicht geeignet.

**Aluminium products**  
For sterilisation the following processes can be used safely:

- autoclave max. 134°, chemiclave max. 132° or dry heat max. 180°.
- Refer to manufacturer's instructions for cycle and time process.
- Do not use dish washer.
- Do not use ultrasonic bath.
- Be careful when using disinfecting liquids; some are incompatible with Aluminium; read carefully the directions for use.

### Kofferdam-Instrumente

### Rubberdam instruments

#### Klammern, regular

#### Clamps, regular



**HSH 210-00**  
*nr. 0*  
für Prämolaren  
for premolars  
CE



**HSH 210-03**  
*nr. 2A*  
für Prämolaren  
for premolars  
CE



**HSH 211-01**  
*nr. 1*  
für Prämolaren  
for premolars  
CE



**HSH 212-02**  
*nr. 2*  
für Prämolaren  
for premolars  
CE



**HSH 212-03**  
*nr. 3*  
für Molaren  
for molars  
CE



**HSH 212-04**  
*nr. 4*  
für Molaren  
for molars  
CE



**HSH 212-10**  
*nr. W2A*  
für Prämolaren  
for premolars  
CE



**HSH 212-22**  
*nr. 22*  
für Prämolaren  
for premolars  
CE



**HSH 213-07**  
*nr. 7*  
für Molaren  
for molars  
CE



**HSH 214-70**  
*nr. 7A*  
für Molaren  
for molars  
CE



**HSH 215-08**  
*nr. 8*  
für Molaren  
for molars  
CE



**HSH 216-80**  
*nr. 8A*  
für Molaren  
for molars  
CE



**HSH 217-14**  
*nr. 14A*  
für Molaren  
for molars  
CE



**HSH 218-09**  
*nr. 9*  
Labial  
CE

#### Klammern, Neu

#### Clamps, new



**HSH 219-21**  
*nr. 212*  
Labial  
CE

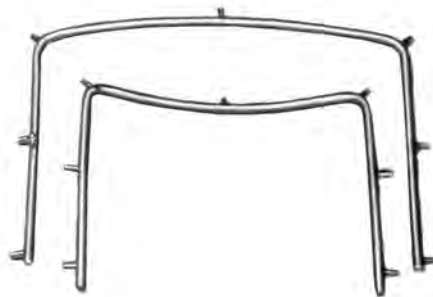

**HSH 171-01**  
Kofferdam-Rahmen, für Erwachsene  
Rubber dam frame, for adults

**HSH 172-02**  
Kofferdam-Rahmen, für Kinder  
Rubber dam frame, for children  
CE



**HSH 200-08**  
Bord für 8 Klammern, rostfrei  
Tray for 8 clamps, stainless



Alle mit CE gekennzeichneten Produkte sind Medizinprodukte. | All products with CE marking are medical devices.

**Dappengläser + Standgefäße  
Dappen glasses + jars**



**Dappengläser**

- ✓ aus farbigem Glas, zehnkant, griffsicher
- ✓ auf beiden Seiten unterschiedlich ausgeformt
- ✓ geeignet zum Anrühren von Zementen und Kunststoffen
- ✓ nicht autoklavierbar
- ✓ ca. 2 – 3 ml Fassungsvermögen
- ✓ Größe: 32 mm / 30 mm hoch

**Dappen glasses**

- ✓ colored glass, ten square, secure grip
- ✓ on both sides formed differently
- ✓ suitable for mixing cement and plastics
- ✓ not autoclavable
- ✓ 2 – 3 ml capacity
- ✓ Size: 32 mm / 30 mm high

GLASSES



**HSM 215-01**  
klar  
clear



**HSM 216-01**  
gelb  
yellow



**HSM 217-01**  
rosalin  
noble rose



**HSM 218-01**  
grün  
green



**HSM 219-01**  
blau  
blue



**HWM 064-00**  
50 x 100 mm

Standgefäße ohne Deckel  
Jars without lid

## Konservierende Behandlung Conservative treatment

7

### Bohrerstände Bur stands



#### HWM 040-84

150 x 75 x 14 mm  
für 84 Bohrer (42 Stück 1,6 mm Ø und 42 Stück 2,4 mm Ø)  
for 84 burs (42 pieces 1,6 mm Ø and 42 pieces 2,4 mm Ø)

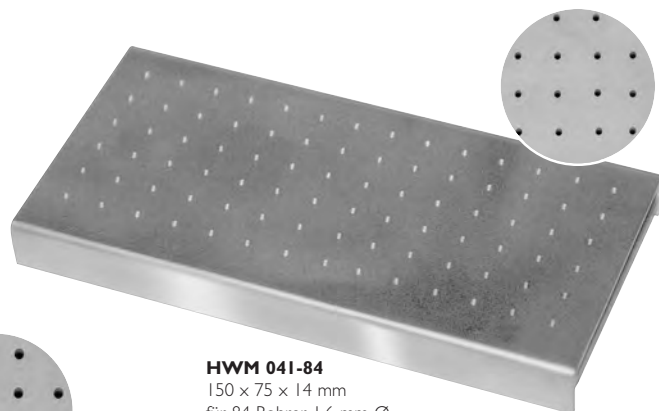

#### HWM 041-84

150 x 75 x 14 mm  
für 84 Bohrer 1,6 mm Ø  
for 84 burs 1,6 mm Ø

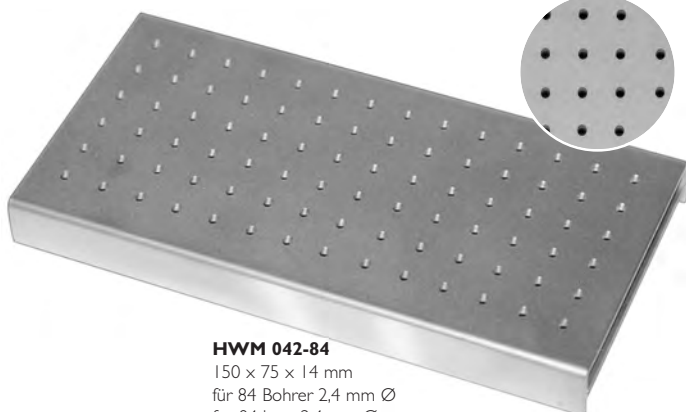

#### HWM 042-84

150 x 75 x 14 mm  
für 84 Bohrer 2,4 mm Ø  
for 84 burs 2,4 mm Ø



#### HWM 045-08

35 x 28 x 28 mm

Bohrerstände für 8 Bohrer (4 x FG / 4 x RA)  
rostfreier Stahl, selbstsichernde Abdeckung, Lieferung mit 4 austauschbaren farbigen Silikonstreifen (blau, gelb, grün, rot)  
ideal für Ultraschallbäder; Reinigungs- und Desinfektionsgeräte (für Steribeutel geeignet)

Bur stands for 8 burs (4 x FG / 4 x RA)  
stainless steel, self locking cover, delivered with 4 replaceable coloured silicone strips (blue, yellow, green, red)  
ideal for use in ultrasonic baths, cleaners, disinfectors (can be placed in autoclave pouches)

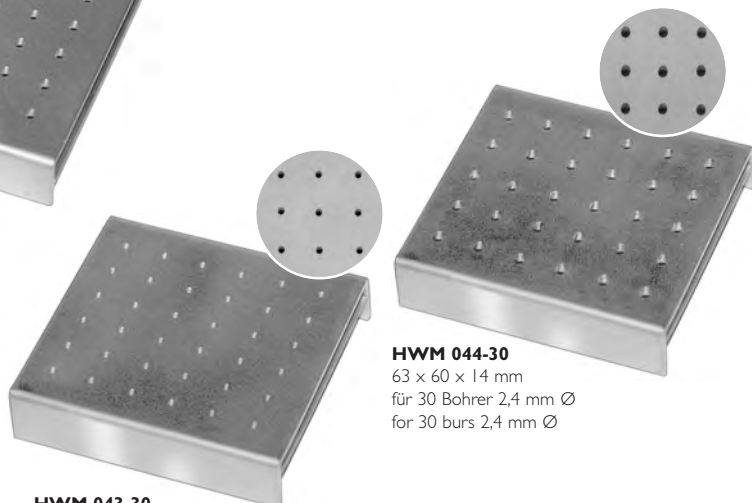

#### HWM 043-30

63 x 60 x 14 mm  
für 30 Bohrer 1,6 mm Ø  
for 30 burs 1,6 mm Ø

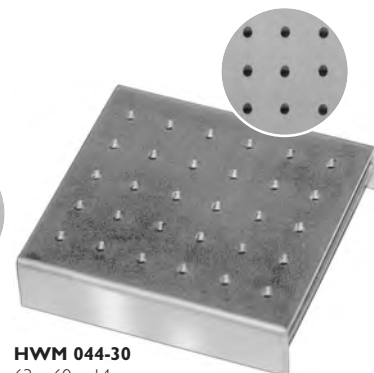

#### HWM 044-30

63 x 60 x 14 mm  
für 30 Bohrer 2,4 mm Ø  
for 30 burs 2,4 mm Ø



#### HWM 050-17

60 x 40 x 28 mm

Bohrerstände für 17 Bohrer (12 x FG / 5 x RA)  
rostfreier Stahl, selbstsichernde Abdeckung, Lieferung mit 4 austauschbaren farbigen Silikonstreifen (blau, gelb, grün, rot)  
ideal für Ultraschallbäder; Reinigungs- und Desinfektionsgeräte (für Steribeutel geeignet)

Bur stands for 17 burs (12 x FG / 5 x RA)  
stainless steel, self locking cover, delivered with 4 replaceable coloured silicone strips (blue, yellow, green, red)  
ideal for use in ultrasonic baths, cleaners, disinfectors (can be placed in autoclave pouches)

Alle mit CE gekennzeichneten Produkte sind Medizinprodukte. | All products marked with CE are medical devices.

Kroneninstrumente  
Crown instruments



**HSB 106-18  
Hammacher**

180 mm  
Spezial-Messer (Marginalmesser)  
zum Beschneiden von Silikon-Abdrücken  
Special knife (marginal knife)  
for clipping of impressions in silicone



**HSL 164-14  
Hammacher**  
140 mm

CE

**Kronenspreizzange**

Eine durch geriefte Arbeitsteile exakt greifende und parallel öffnende Kronenspreizzange. Leichte Platzierung und übersichtliches Arbeiten nach Aufräsung der Krone.

**Crown spreader pliers**

Crown spreader pliers with an exact grip, due to fluted work parts, and opening parallel. Easy placing and good view of work area after the crown is fraised open.



**HSL 175-00  
Universal**  
Kronenaufbieger  
Crown spreader

CE



**HSL 169-01**  
*fig. 1*  
für Frontzähne  
for frontals

CE



**HSL 172-01**  
*fig. 1*  
für Frontzähne  
for frontals



**HSL 173-02**  
*fig. 2*  
für Prämolaren  
und Molaren  
for premolars  
and molars

CE

**HSL 170-02**  
*fig. 2*  
für Prämolaren und Molaren  
for premolars and molars

CE

**Kroneninstrumente**  
**Crown instruments**

**HSL 206-13**  
 Unterkiefer, Front- Eckzähne und Prämolaren  
 Lower jaw, front teeth, canines, bicuspids

Lieferumfang: Zange inkl. 10 g Kontaktpulver  
 und 10 Paar Ersatz-Gummibacken  
 Scope of supply: forceps incl. 10 g of contact powder  
 and 10 pairs of spare rubber jaws

**HSL 206-33**  
 10 g Kontaktpulver und 10 Paar Ersatz-Gummibacken  
 für HSL 206-13, *Autoklavierbar: 160 bis 180 °C.*  
 10 g of contact powder and 10 pairs of spare rubber jaws  
 for HSL 206-13, *Autoclavable: 160 to 180 °C.*

CE



**HSL 211-16**  
 180 mm  
 Provisorienzange nach Gutowski – zum sicheren Fassen von  
 provisorischen Kronen und Nervinstrumenten  
 Provisional crown pliers to Gutowski – for the safe seizing of  
 provisional crowns and nerve instruments

CE



**HSL 183-00**  
**Morell**  
 Kronenabnehmer, komplett mit 3 Ansätzen fig. 1 - 3  
 Crown remover, complete with 3 attachments fig. 1 - 3

CE



**HSL 184-00**  
 Abnehmer  
 mit Gewicht, allein  
 Remover  
 with weight, only

CE



**HSL 185-01**  
 fig. 1  
 Aufsatz, allein  
 Attachment, only

CE



**HSL 186-02**  
 fig. 2  
 Aufsatz, allein  
 Attachment, only

CE



**HSL 187-03**  
 fig. 3  
 Aufsatz, allein  
 Attachment, only

CE

**Kroneninstrumente  
Crown instruments**



**HSL 192-00  
Crown butler**  
215 mm  
Komplett mit 3 Ansätzen  
Complete with 3 attachments  
CE



**HSL 193-01  
Crown butler  
Ansatz 1  
Attachment 1**  
CE



**HSL 194-02  
Crown butler  
Ansatz 2  
Attachment 2**  
CE



**HSL 194-03  
Crown butler  
Ansatz 3  
Attachment 3**  
CE



**HSL 177-05**  
CE



**HSL 177-70**  
70 mm  
CE



**HSL 177-60**  
CE

**HSL 177-80**  
80 mm  
CE

**Brückenabnehmer-Ansatz  
HSL 177-05**

mit 2 Reservedrähren 70 und 80 mm.

Der Ansatz ist geeignet für unseren Crown butler und ähnliches System wie HSL 192-00

**Bridge-remover attachment HSL 177-05**

with 2 interchangeable wires 70 and 80 mm.

The attachment is suitable for our Crown butler and similar systems as HSL 192-00

**Die Instrumente "Crown butler"**

sind neuartige Kronenabnehmer zum automatischen Abnehmen von Kronen und Brücken. Die Einhand-Bedienung des Gerätes läßt die andere Hand zur exakten Fixierung an Krone oder Brücke frei. Die Stärke des Schlagimpulses ist in verschiedenen Stufen regelbar.

**Lieferform: 1 Gerät mit 2 verschiedenen austauschbaren Ansätzen.**

**The instruments "Crown butler"**

are novel crown removers for the automatic loosening of crowns and bridges. The one-hand operation allows the exact fixing of the instrument on the crown or bridge. The power of the impulses is adjustable in different degrees of intensity.

**We supply 1 instrument with 2 different interchangeable attachments.**

**HSL 196-01  
Schlüssel  
Key**  
CE



**HSL 195-01  
Ansatz 1  
Attachment 1**  
CE



**HSL 195-02  
Ansatz 2  
Attachment 2**  
CE



**HSL 195-03  
Ansatz 3  
Attachment 3**  
CE



**HSL 195-00  
Crown Rocket**  
Komplett mit 3 Ansätzen und 2 Schlüsseln  
Complete with 3 attachments and 2 keys  
CE



**Misch- und Laborspatel  
Mixing spatulas**
**Zeichenerklärung / Explicación de abreviaturas**

SB = Spatelbreite	SL = Spatel-Länge	L = Gesamtlänge
SB = Width of spatula	SL = Length of spatula	L = Length overall



**HWN 250-18**  
L = 180 mm  
SB = 18 mm  
SL = 90 mm

**HWN 251-20**  
L = 200 mm  
SB = 18 mm  
SL = 110 mm

**HWN 252-22**  
L = 220 mm  
SB = 18 mm  
SL = 125 mm  
aus Wironit Stahl  
from Wironit steel



**HWN 270-21**  
L = 215 mm  
SB = 21 mm  
aus Wironit Stahl  
from Wironit steel



**HWN 271-21**  
210 mm  
SB = 30 mm  
SL = 115 mm  
aus Wironit Stahl  
from Wironit steel



**HWN 272-22**  
L = 220 mm  
aus Wironit Stahl  
from Wironit steel



**HWN 273-21  
Ash 8x**  
L = 215 mm  
aus Wironit Stahl  
from Wironit steel

*federnd  
elastic*



**HSN 200-08**  
flexibel  
L = 160 mm  
SL = 80 mm

**HSN 201-10**  
flexibel  
L = 190 mm  
SL = 105 mm

**HSN 202-13**  
flexibel  
L = 220 mm  
SL = 130 mm



**HSN 220-08**  
L = a 180 mm  
SL = 80 mm

**HSN 221-10**  
L = 205 mm  
SL = 105 mm

**HSN 222-13**  
L = 230 mm  
SL = 130 mm  
Spatel-Messer, flexibel  
Spatula-knive, flexible



# SERVICE

wird bei uns groß geschrieben!

We consider SERVICE one of the main aspects of our philosophy!

Zu unseren Leistungen gehört selbstverständlich auch ein Reparaturservice,  
der unter anderem folgende Arbeiten umfaßt:

As part of our service, we offer our customers a repair service,  
including the following work processes:



1

**Diamantierung**  
**Diamond coating**

Diamantierung und Nachdiamantierung von  
Zahnzangen, Pinzetten, Teleskopzangen, etc., ...  
Diamond coating and re-coating of  
extracting forceps, telescope crown pliers, etc.,...

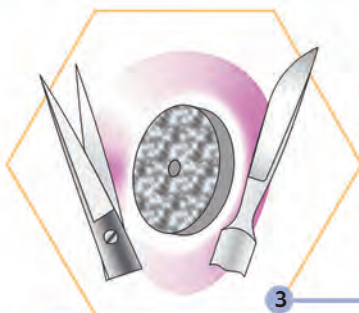

3

**Schärfen**  
**Tool sharpening**

Schärfen und Nachschleifen von Scheren, Skalpell  
und sonstigen schneidenden Instrumenten  
Sharpening and regrinding of scissors, scalpels  
and other cutting instruments



5

**Oberflächenbearbeitung**  
**Surface finishing**

Oberflächenbearbeitung der Instrumente, wie:  
Mattieren, Polieren, Verchromen und Vergolden  
Surface finishing of instruments, such as  
matt finishing, polishing, chrome and gold plating



7

**Sonderanfertigung**  
**Customised Instruments**

Wir produzieren für Sie in Sonderanfertigung Instrumente  
nach Muster, Skizze oder ähnlichem  
For our customers, we manufacture custom-made instruments  
to specification from your samples, drawings etc.



2

**TC-Einsätze**  
**TC-inserts**

Erneuerung von Hartmetall-Einlagen für  
Nadelhalter und technische Zangen  
Replacement of tungsten carbide inserts for  
needle holders and technical pliers



4

**Nacharbeit**  
**Refinishing**

Komplettes Nacharbeiten älterer Instrumente, wie:  
Nachpolieren, Richten, gängig machen und Entrosten  
Complete refinishing of old instruments, such as  
surface redressing, alignment, rust removal and making instruments patent

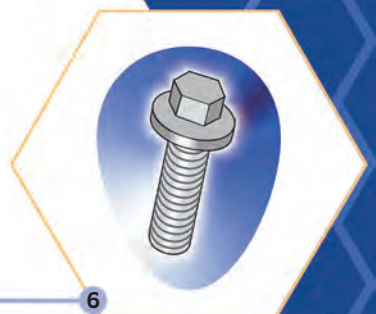

6

**Ersatz**  
**Replacement of parts**

Ersatz von Schrauben, Stiften oder Nieten  
Replacement of screws, pins and rivets

**HWL 200-00**

Satz zu 22 Abdrucklöffel, gelocht  
enthaltend je 1 Stück HWL 201-00 bis HWL 230-03

Set of 22 impression trays, perforated,  
consisting of 1 pc each HWL 201-00 to HWL 230-03

**Original Ehrlicke-Abdrucklöffel – perforiert  
Impression Trays according to Ehrlicke – perforated**

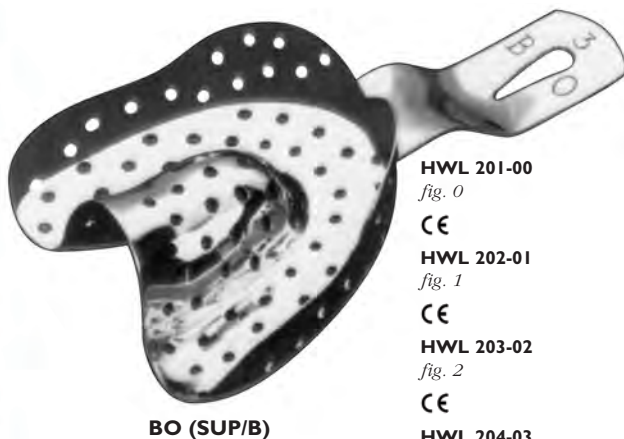

**BO (SUP/B)**

**HWL 201-00**  
*fig. 0*

CE

**HWL 202-01**  
*fig. 1*

CE

**HWL 203-02**  
*fig. 2*

CE

**HWL 204-03**  
*fig. 3*

CE

**HWL 205-04**  
*fig. 4*

CE

Für bezahnten Oberkiefer  
For toothed upper jaws

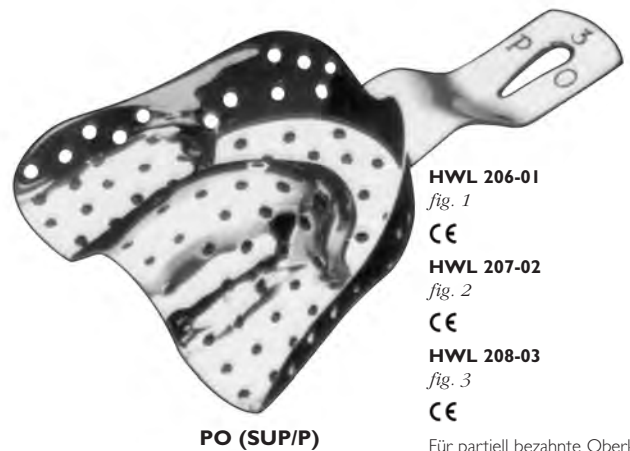

**PO (SUP/P)**

**HWL 206-01**  
*fig. 1*

CE

**HWL 207-02**  
*fig. 2*

CE

**HWL 208-03**  
*fig. 3*

CE

Für partiell bezahnte Oberkiefer  
For partially toothed upper jaws

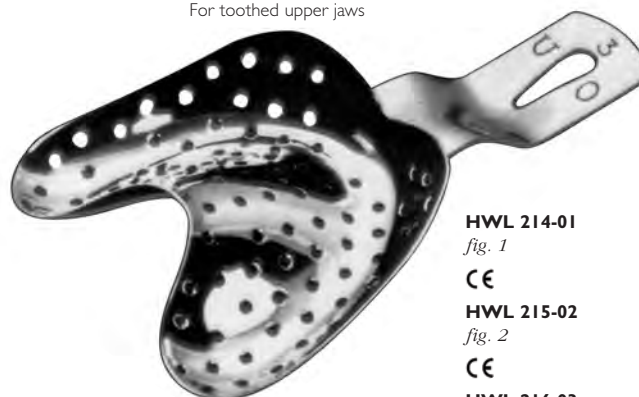

**UO (SUP/U)**

**HWL 214-01**  
*fig. 1*

CE

**HWL 215-02**  
*fig. 2*

CE

**HWL 216-03**  
*fig. 3*

CE

Für unbezahnte Oberkiefer  
For edentulous upper jaws

Alle mit CE gekennzeichneten Produkte sind Medizinprodukte. | All products marked with CE are medical devices.



BU (INF/B)

**HWL 218-00**  
*fig. 0*

CE

**HWL 219-01**  
*fig. 1*

CE

**HWL 220-02**  
*fig. 2*

CE

**HWL 221-03**  
*fig. 3*

CE

**HWL 222-04**  
*fig. 4*

CE

Für bezahnte Unterkiefer  
For toothed lower jaws

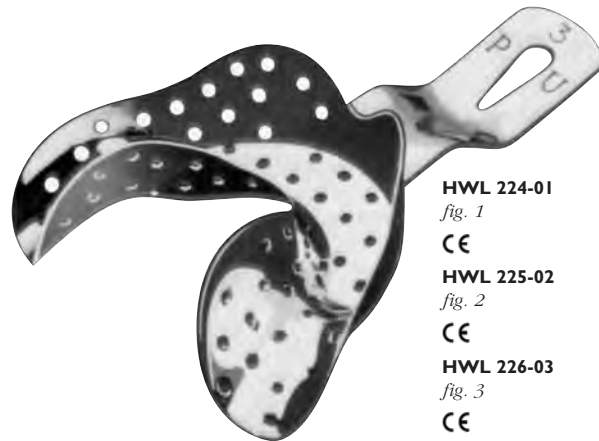

PU (INF/F)

**HWL 224-01**  
*fig. 1*

CE

**HWL 225-02**  
*fig. 2*

CE

**HWL 226-03**  
*fig. 3*

CE

Für partiell bezahnte Unterkiefer  
For partially toothed lower jaws



**HWL 232-01**  
*fig. 1L*

CE

**HWL 233-02**  
*fig. 2L*

CE

**HWL 234-03**  
*fig. 3L*

CE

Für partielle Abdrücke  
For partial impressions

**HWL 236-01**  
*fig. 1R*

CE

**HWL 237-02**  
*fig. 2R*

CE

**HWL 238-03**  
*fig. 3R*

CE

Für partielle Abdrücke  
For partial impressions

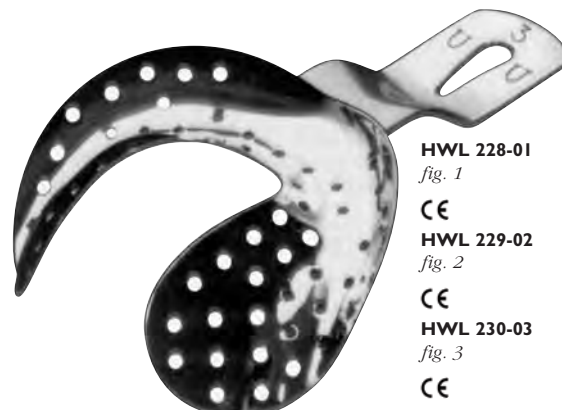

UU (INF/U)

**HWL 228-01**  
*fig. 1*

CE

**HWL 229-02**  
*fig. 2*

CE

**HWL 230-03**  
*fig. 3*

CE

Für unbezahnte Unterkiefer  
For edentulous lower jaws

**"Wiro-lock" Abdrucklöffel**

- ✓ "Wiro-lock" Abdrucklöffel werden gefertigt aus dem hochwertigen, korrosionsbeständigen Edelstahl WIRONIT.

**Ein absolutes Qualitätsprodukt!**

- ✓ Diese "Wiro-lock" Abdrucklöffel verfügen über eine Bördelung, dem Retentionsrandabschluß. Somit sind sie in der Lage, Abformmaterialien auch ohne Haftmittel zu halten.
- ✓ "Wiro-lock" Abdrucklöffel kann man im Ultraschallbad reinigen und selbstverständlich mit allen gebräuchlichen Verfahren sterilisieren.

**"Wiro-lock" Impression Trays**

- ✓ "Wiro-lock" Impression Trays are made of the high value, corrosion proof WIRONIT Steel.

**An absolute high-quality-product!**

- ✓ These "Wiro-lock" Impression Trays dispose of a retention edge lock. So they are able to hold the i mpression material without using any adhesives.
- ✓ "Wiro-lock" Impression Trays might be cleaned inside a supersonic bath and of course they are sterilizable by any usual methods.

<b>XL =</b>	extra groß extra large	<b>S =</b>	klein small
<b>L =</b>	groß large	<b>XS =</b>	extra-klein extra small
<b>M =</b>	mittel medium		

**Regular**
**Oberkiefer  
Upper jaws**

**HWL 301-01**  
(OK-1 XL BS5 US-U11)

**CE**

**HWL 302-02**  
(OK-2 L BS3 US-U12)

**CE**

**HWL 303-03**  
(OK-3 M BS2A US-U13)

**CE**

**HWL 304-04**  
(OK-4 S BS2 US-U14)

**CE**

**HWL 305-05**  
(OK-5 XS BS1 US-U15)

**CE**

Alle mit CE gekennzeichneten Produkte sind Medizinprodukte. | All products marked with CE are medical devices.



**Regular**

**Unterkiefer  
Lower jaws**

<b>XL =</b>	extra groß extra large
<b>L =</b>	groß large
<b>M =</b>	mittel medium
<b>S =</b>	klein small
<b>XS =</b>	extra-klein extra small



**HWL 311-01**  
(UK-1 XL B15 US-L11)  
CE



**HWL 313-03**  
(UK-3 M B12A US-L13)  
CE



**HWL 312-02**  
(UK-2 L B13 US-L12)  
CE



**HWL 314-04**  
(UK-4 S B12 US-L14)  
CE



**HWL 315-05**  
(UK-5 XS B11 US-L15)  
CE

**HWL 300-00**

Satz mit 10 Abdrucklöffeln, bestehend aus:  
 5 Oberkiefer: HWL 301-01 bis HWL 305-05  
 5 Unterkiefer: HWL 311-01 bis HWL 315-05

Set with 10 impression trays, consisting of:  
 5 upper jaws: HWL 301-01 to HWL 305-05  
 5 lower jaws: HWL 311-01 to HWL 315-05

Alle mit CE gekennzeichneten Produkte sind Medizinprodukte. | All products marked with CE are medical devices.



**Kindergrößen, Oberkiefer**  
**Children sizes, upper jaws**



**HWL 371-15**  
(OK-15 L)  
CE



**HWL 372-16**  
(OK-16 M)  
CE



**HWL 373-17**  
(OK-17 S)  
CE



**HWL 374-18**  
(OK-18 XS)  
CE

<b>L =</b>	groß / Kind large / child
<b>M =</b>	mittel / Kind medium / child
<b>S =</b>	klein / Kind small / child
<b>XS =</b>	extra-klein / Kind extra small / child

Alle mit CE gekennzeichneten Produkte sind Medizinprodukte. | All products marked with CE are medical devices.



Kindergrößen, Unterkiefer  
Children sizes, lower jaws



**HWL 376-15**  
(UK-15 L)  
CE



**HWL 377-16**  
(UK-16 M)  
CE



**HWL 378-17**  
(UK-17 S)  
CE



**HWL 379-18**  
(UK-18 XS)  
CE

#### HWL 370-08

Satz mit 8 Löffeln f. Kinder, bestehend aus:  
4 Oberkiefer: HWL 371-15 bis HWL 374-18  
4 Unterkiefer: HWL 376-15 bis HWL 379-18

Set with 8 children sized impression trays, consisting of:  
4 upper jaws: HWL 371-15 to HWL 374-18  
4 lower jaws: HWL 376-15 to HWL 379-18

Alle mit CE gekennzeichneten Produkte sind Medizinprodukte. | All products marked with CE are medical devices.



perforiert  
perforated

Oberkiefer  
Upper jaws



**HWL 306-01**  
(OK-1P XL PS6 US-7)  
CE



**HWL 307-02**  
(OK-2P L PS5 US-5)  
CE



**HWL 308-03**  
(OK-3P M PS4 US-4)  
CE



**HWL 309-04**  
(OK-4P S PS3 US-1)  
CE

<b>XL =</b>	extra groß extra large
<b>L =</b>	groß large
<b>M =</b>	mittel medium
<b>S =</b>	klein small

Alle mit CE gekennzeichneten Produkte sind Medizinprodukte. | All products marked with CE are medical devices.





perforiert  
perforated

Unterkiefer  
Lower jaws



**HWL 316-01**  
(UK-1P XL P16 US-24)

CE

**XL =** extra groß  
extra large

**L =** groß  
large

**M =** mittel  
medium

**S =** klein  
small



**HWL 317-02**  
(UK-2P L P15 US-22)

CE



**HWL 318-03**  
(UK-3P M P14 US-21)

CE

#### HWL 300-08

Satz mit 8 Abdrucklöffeln, bestehend aus:

4 Oberkiefer: HWL 306-01 bis HWL 309-04  
4 Unterkiefer: HWL 316-01 bis HWL 319-04

Set with 8 impression trays, consisting of:

4 upper jaws: HWL 306-01 to HWL 309-04  
4 lower jaws: HWL 316-01 to HWL 319-04



**HWL 319-04**  
(UK-4P S P13 US-20)

CE

Alle mit CE gekennzeichneten Produkte sind Medizinprodukte. | All products marked with CE are medical devices.



**Kindergrößen, perforiert, Oberkiefer**  
Children sizes, perforated, upper jaws



**HWL 381-15**  
(OK-15P L)  
CE



**HWL 382-16**  
(OK-16P M)  
CE



**HWL 383-17**  
(OK-17P S)  
CE



**HWL 384-18**  
(OK-18P XS)  
CE

<b>L =</b>	groß / Kind large / child
<b>M =</b>	mittel / Kind medium / child
<b>S =</b>	klein / Kind small / child
<b>XS =</b>	extra-klein / Kind extra small / child

Alle mit CE gekennzeichneten Produkte sind Medizinprodukte. | All products marked with CE are medical devices.



Kindergrößen, perforiert, Unterkiefer  
Children sizes, perforated, lower jaws



**HWL 386-15**  
(UK-15P L)  
CE



**HWL 388-17**  
(UK-17P S)  
CE



**HWL 387-16**  
(UK-16P M)  
CE

#### HWL 380-08

Satz mit 8 Kinder-Abdrucklöffeln, perforiert, bestehend aus:  
4 Oberkiefer: HWL 381-15 bis HWL 384-18  
4 Unterkiefer: HWL 386-15 bis HWL 389-18

Set with 8 children sized impression trays, perforated, consisting of:  
4 upper jaws: HWL 381-15 to HWL 384-18  
4 lower jaws: HWL 386-15 to HWL 389-18



**HWL 389-18**  
(UK-18P XS)  
CE

Alle mit CE gekennzeichneten Produkte sind Medizinprodukte. | All products marked with CE are medical devices.



Löffel für die Totalprothetik,  
**Oberkiefer, regular**  
Impression trays for the  
complete denture-prosthetics,  
**upper jaws, regular**



**HWL 341-01**  
(OK-1E XL)

CE



**HWL 342-02**  
(OK-2E L)

CE



**HWL 343-03**  
(OK-3E M)

CE



**HWL 344-04**  
(OK-4E S)

CE

**Edentulous**  
für unbezahnte Kiefer  
**Edentulous**  
for edentulous jaws

Alle mit CE gekennzeichneten Produkte sind Medizinprodukte. | All products marked with CE are medical devices.



Löffel für die Totalprothetik,  
**Unterkiefer, regular**  
Impression trays for the  
complete denture-prosthetics,  
**lower jaws, regular**



**HWL 345-05**  
(UK-5E XL)  
CE



**HWL 347-07**  
(UK-7E M)  
CE



**HWL 346-06**  
(UK-6E L)  
CE



**HWL 348-08**  
(UK-8E S)  
CE

**Edentulous**  
für unbezahnte Kiefer  
**Edentulous**  
for edentulous jaws

Alle mit CE gekennzeichneten Produkte sind Medizinprodukte. | All products marked with CE are medical devices.

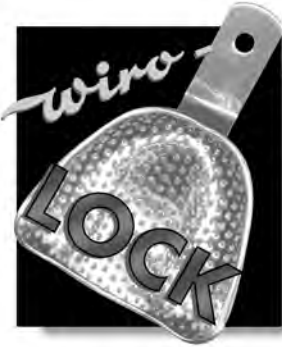

Löffel für die Totalprothetik,  
**Oberkiefer, perforiert**  
Impression trays for the complete  
denture-prosthetics,  
**upper jaws, perforated**



**HWL 351-01**  
(OK-1EP XL 61)  
CE



**HWL 353-03**  
(OK-3EP M 63)  
CE

**Edentulous**  
für unbezahnte Kiefer  
**Edentulous**  
for edentulous jaws



**HWL 352-02**  
(OK-2EP L 62)  
CE



**HWL 354-04**  
(OK-4EP S 64)  
CE

Alle mit CE gekennzeichneten Produkte sind Medizinprodukte. | All products marked with CE are medical devices.



Löffel für die Totalprothetik,  
**Unterkiefer, perforiert**  
Impression-trays for the complete  
denture-prosthetics,  
**lower jaws, perforated**



**HWL 355-05**  
(UK-5EP XL 66)  
CE



**HWL 357-07**  
(UK-7EP M 68)  
CE



**HWL 356-06**  
(UK-6EP L 67)  
CE

**Edentulous**  
für unbezahnte Kiefer  
**Edentulous**  
for edentulous jaws



**HWL 358-08**  
(UK-8EP S 69)  
CE

Alle mit CE gekennzeichneten Produkte sind Medizinprodukte. | All products marked with CE are medical devices.



**Regular**

**teilbezahnt  
partially toothed**



**HWL 321-30**  
(30 links / left  
CE

**HWL 322-31**  
(31 rechts / right  
CE



**HWL 323-33**  
(33 OK-Front / upper jaws, anterior  
CE



**HWL 324-32**  
(32 UK-Front  
lower jaws, anterior  
CE

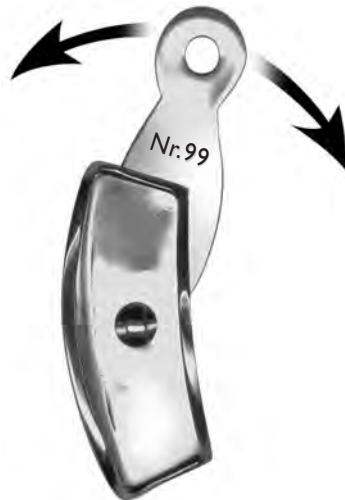

**HWL 325-99**  
(99 Seitenzahnbereich mit Drehgriff  
lateral, with swivel handel  
CE



**HWL 330-30**  
(30P links / left  
CE

**HWL 331-31**  
(31P rechts / right  
CE



**perforiert  
perforated**



**HWL 332-33**  
(33P OK-Front / upper jaws, anterior  
CE



**HWL 333-32**  
(32P UK-Front / lower jaws, anterior  
CE



**HWL 334-99**  
(99P Seitenzahnbereich mit Drehgriff  
lateral, with swivel handel  
CE

Alle mit CE gekennzeichneten Produkte sind Medizinprodukte. | All products marked with CE are medical devices.



HAMMACHER Farbinstrumente  
HAMMACHER Coloured instruments



HSL 023-15  
fig. 1 - 5

PKT-Aufwachsinstrumentensatz  
mit farbcodierten Griffen + Pinsel HSL 147-00

PKT-Set of waxing instruments  
with colored handles + brush HSL 147-00

**HSL 024-01**  
fig. 1  
**P.K. Thomas**  
Wachsauftragen  
und Erweichen  
Apply wax and  
soften

**HSL 025-02**  
fig. 2  
**P.K. Thomas**  
Zum Bearbeiten von  
Höckerkegeln,  
Höckerschragflächen  
und Dreieckswülsten  
For dressing conical,  
sloping and trigonal  
protuberances

**HSL 026-03**  
fig. 3  
**P.K. Thomas**  
Zum Verkleinern  
der Kauflächen  
For reducing the  
areas of morsal  
surfaces

**HSL 027-04**  
fig. 4  
**P.K. Thomas**  
Zum Nachbearbeiten  
der Höckerkegel und  
Glätten der äusseren  
Konturen  
For finishing of conical  
protuberances and  
smoothing exposed  
surfaces

**HSL 028-05**  
fig. 5  
**P.K. Thomas**  
Zum Verkleinern der  
Dreieckswülste  
For reducing the  
areas of trigonal  
protuberances



PKT-Aufwachsinstrumente

✓ Einzig mögliche  
Reinigungsart bei eloxierten  
Alu-Instrumenten: manuell mit  
Spülmittellauge (kein  
Ultraschall).

**Sterilisation:** nur  
Heißluftsterilisator. Bei allen  
anderen Reinigungs-, bzw.  
Sterilisationsarten wird die farbig  
eloxierte Oberfläche zerstört.

PKT Waxing instruments

✓ Only possible type of  
cleaning for anodised aluminium  
instruments: manually with  
detergent solution (no  
ultrasonics).

**Sterilisation:** only hot air  
steriliser. For all other types of  
cleaning and/or sterilisation the  
coloured anodised surface is  
destroyed.

Modellierinstrumente  
Modelling instrumentsHSL 050-12  
Mini-Le CronHSL 051-17  
Le CronHSL 052-17  
Le CronHSL 054-00  
HylinHSL 060-03  
ZahleHSL 062-07  
no. 7  
BealeHSL 562-06  
fig. 6  
Wachspinsel zum Glätten der Oberflächen  
Wax brush for smoothing of the surfaces

Wachs- und Gipsmesser  
Wax and plaster knives



**HSL 108-13**  
**Fahnenstock**  
130 mm  
Wachsmesser; Ganzmetall  
Wax knife, all-metal

**HSL 109-17**  
**Fahnenstock**  
175 mm



**HSL 112-13**  
**Fahnenstock**  
130 mm  
Wachsmesser aus rostfreiem Stahl, schwarzes Holzheft  
Wax knives from stainless steel, black wooden handle

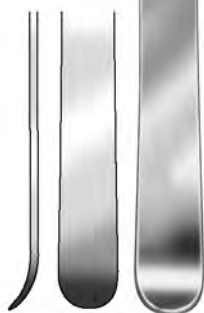

**HSL 121-18**  
180 mm

Gipsmesser; aus rostfreiem Stahl  
Plaster knives, from stainless steel



**HSL 122-16**  
**Gritman**  
165 mm

KEIN MEDIZINPRODUKT  
nur zur Vergleichsmessung

NO MEDICAL DEVICES  
only for comparative measuring

## Messinstrumente Measuring instruments



**HSL 245-00  
Iwanson**  
100 mm  
nicht sterilisierbar  
not sterilizable

für Metall  
for metal

**HSL 246-00  
Iwanson**  
100 mm  
nicht sterilisierbar  
not sterilizable

für Wachs  
for wax



**HSL 245-00 + HSL 246-00  
Iwanson**  
100 mm  
nicht sterilisierbar  
not sterilizable

**Meßzirkel, Meßbereich 0-10 mm  
Measuring calipers, measuring range 0-10 mm**



**HSL 247-00  
Boley**  
140 mm  
nicht sterilisierbar  
not sterilizable

**Schieblehre  
Meßbereich 0-100mm  
Sliding caliper  
measuring range 0-100mm**

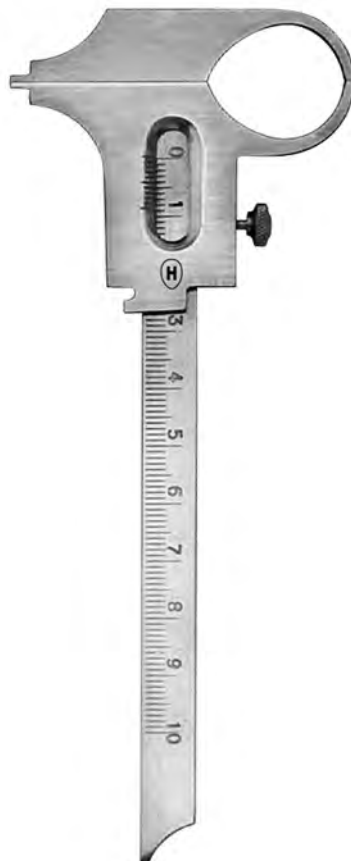

**HSL 247-10  
Boley**  
140 mm  
nicht sterilisierbar  
not sterilizable

**Schieblehre  
Meßbereich 0-100mm  
Sliding caliper  
measuring range 0-100mm**



**HSL 245-12  
Interlook-Hammacher**  
125 mm  
nicht sterilisierbar  
not sterilizable

**"Interlook"**  
der Taster mit den besonderen Enden,  
für mehr Genauigkeit überall.  
**Meßbereich 0-10mm**

**"Interlook"**  
the measuring caliper with very special  
tips, for more precision everywhere.  
**Measuring range 0-10mm**

Alle mit CE gekennzeichneten Produkte sind Medizinprodukte. | All products marked with CE are medical devices.

Messinstrumente  
Measuring instruments



**HSL 246-15**  
Digital-Taschen-Meßschieber  
Digital pocket caliper

**HSL 246-15**

- mit schmal geformten Meßschenkeln
- mit Kreuzspitzen und Tiefenmeßstab
- aus rostfreiem Stahl, gehärtet
- extra große Anzeige, Ablesung 0,01mm / .0005", umschaltbar
- Schalter ein/aus, DIN 862, Metallgehäuse, inkl. Etui., ohne Antriebsrolle
- Meßbereich: 70 mm, Schnabellänge: 20 mm
  
- with narrow shaped measuring jaws
- with cross peaks and a rod to measure the depth
- from stainless steel, hardened and tempered
- jumbo display, reading 0,01mm / .0005"
- switch on / off, DIN 862, metal casing, incl. wallet, without roller
- measuring range: 100 mm, jaws: 30 mm

Alle mit CE gekennzeichneten Produkte sind Medizinprodukte. | All products marked with CE are medical devices.

Teleskopkronenzangen  
Telescope crown pliers

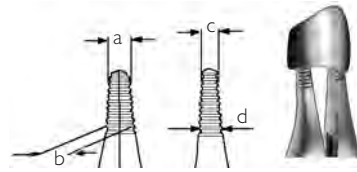

	a	b	c	d
<b>HSL 233-12</b>	2,8	3,0	2,2	2,4 mm
<b>HSL 234-12</b>	3,5	5,0	2,1	3,0 mm
<b>HSL 235-15</b>	4,2	5,8	3,0	4,0 mm



**HSL 233-12**  
**Hammacher**  
120 mm  
für flache Teleskopkronen im Front- u. Seitenzahnbereich, mit Diamantierung  
for flat telescope crowns, front and lateral area, with diamond tips



**HSL 234-12**  
**Hammacher**  
120 mm  
mit Diamantierung  
with diamond tips



**HSL 235-15**  
**Böhm**  
150 mm  
mit Diamantierung  
with diamond tips

Teleskopkronenzangen  
Telescope crown pliers



**HSL 236-12**  
**Teleflex Mini**  
nach Hoyer  
120 mm



**HSL 237-12**  
**Teleflex**  
nach Hoyer  
120 mm

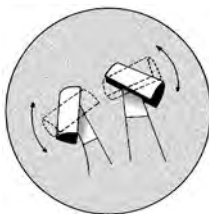

**HSL 238-15**  
**Teleflex**  
nach Hoyer  
150 mm

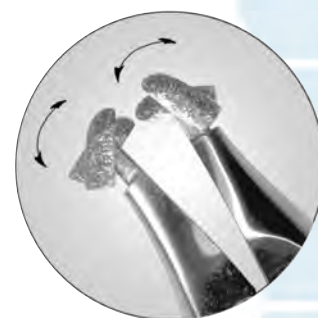
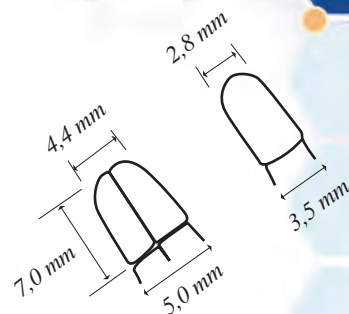

**HSL 2372-12**  
**Teleflex Grazil**  
120 mm  
Teleskopkronenzange  
Telescope crown pliers

**"TELEFLEX MINI"**

Um die hervorragende Haltekraft der Teleflex auch für grazile Frontzahn- und Prämolarenkronen nutzen zu können, gibt es nun die TELEFLEX MINI. Die unübertroffene Friktion der Zange wird wie auch bei der Teleflex durch eine bewegliche Haltebacke erzielt. Durch die großflächige Auflage ist auch die Deformation filigraner Kronen ausgeschlossen. Weiterhin wird eine Rotation um die Anlagepunkte vermieden und somit die diamantierte Fläche nicht punktuell abgenutzt.

**"TELEFLEX MINI"**

The TELEFLEX MINI has been specially developed so that the outstanding retention force of the Teleflex can also be used for delicate crowns on anterior and premolar teeth. As in the case of the Teleflex, the forceps' unrivalled friction is achieved by a movable jaw. The large contact area also prevents any deformation of even the most filigree crowns. Rotation about the points of contact is also avoided, thus preventing local abrasion of

**"TELEFLEX" nach Hoyer**

Die neuartige Teleskopkronenzange bringt dem/der Techniker/in höchste Perfektion und Sicherheit. Bisher nicht erreichte Haltekraft durch flächiges Anliegen der diamantierten Haltebacken auch bei sehr konischen Kronen. Keine Deformation oder Beschädigung der Krone, selbst bei großem Anpreßdruck.

Höchste Lebensdauer der Diamantierung durch geringen Anpreßdruck bei großer Auflage.

**"TELEFLEX" according to Hoyer**

The innovative telescopic forceps for crowns bring the dental technician maximum perfection and security. Hitherto unknown retention as the diamond-lined jaws make full contact, even when highly conical crowns are involved. The crown is not deformed or damaged, even when considerable pressure is applied. Maximum service life of the diamond lining with little contact pressure and a large contact area.

## Teleskopkronen- und Aktivierungszange Telescope crown and activating pliers



**HSL 231-01**  
Ersatzspitz: starr  
Replacement tip: rigid



**HSL 231-02**  
Ersatzspitz: beweglich  
Replacement tip: movable



**HSL 2361-12**  
**Teleflex Mini Hoyer**  
120 mm  
Teleskopkronenzange mit Doppelfeder  
Telescope crown pliers with double spring



**HSL 219-16**  
**Hammacher**  
165 mm  
Teleskop-Aktivierungszange für  
einzel- oder freistehende Teleskope  
(im freien Segment)

**HAMMACHERS Teleskop-Aktivierungszange** ist eine schnelle Hilfe bei frictionslosen Teleskopen. Die Zange bildet neue Haltekräfte entweder mit einem oder mehreren Friktionspunkten.

Telescope activating pliers for separately standing or detached telescopes (in the free segment)

**HAMMACHER'S telescope activating pliers** are a quick help for frictionless telescopes. The pliers create new retention forces either with one or several friction points.



**HSL 231-00**  
130 mm  
Teleskopkronenzange mit einer starren und einer beweglichen Spitze  
Telescope crown pliers with a rigid and a movable tip



**HSL 231-03**  
Inbusschlüssel  
Allen key



Keramik-Instrumente  
Instruments for ceramics



HSL 572-00

HSL 573-00

HSL 574-00

Modellierinstrumente für Keramik  
Modelling carvers for ceramics



**HSB 630-10**  
105 mm  
sterilisierbar / sterilizable

Tiefzieh- / Folienschere, gebogen, mit feiner Zahnung,  
**rostfrei**. Geeignet für alle Arten von Tiefziehfolien.  
Scissors for foils and splints, curved, with micro saw edge,  
**stainless**. Suitable for all types of foils.



**HSE 023-12**  
**Halsted-Mosquito**  
Klemme, fein, gebogen  
Clamp, delicate, curved



**HSE 022-12**  
**Halsted-Mosquito**  
120 mm  
Klemme, fein, gerade  
Clamp, delicate, straight



**HSC 519-17**  
**Hammacher**  
170 mm  
Kronenhaltepinzetten,  
diamantiert, mit Einstellschraube  
Crown holding forceps, diamond  
tips, with adjustable by screw

**verwendbar als:**

- 1) Krampon- und Ligaturzange
- 2-3) Klammerbiegezange
- 4) Bügelbiegezange
- 5) Kneifzange

**to be used as:**

- 1) Pin and ligature pliers
- 2-3) Clasp bending pliers
- 4) Bar bending pliers
- 5) Cutting pliers

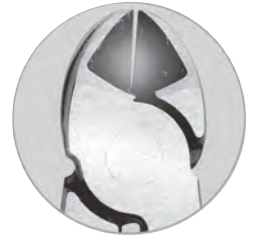

max. 0,9 mm

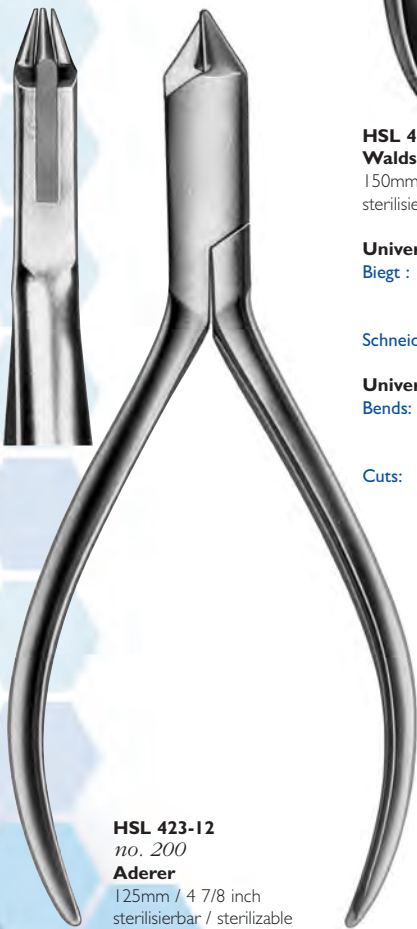

**HSL 423-12**  
no. 200  
**Aderer**

125mm / 4 7/8 inch  
sterilisierbar / sterilizable

**Draht- und Klammerbiegezange**  
für harten Draht bis 0,9 mm / .035" Ø max.

**Wire and clasp bending pliers**  
for hard wire up to 0,9 mm / .035" Ø max.

**HSL 431-15**  
**Waldsachs**

150mm / 5 7/8 inch  
sterilisierbar / sterilizable

**Universalzange**

**Biegt :** harten Draht bis 1,0 mm / .039" Ø max.  
harten Profildraht bis 1,3 x 0,65 mm  
/ .051" x .026" max.

**Schneidet:** harten Draht bis 0,7 mm / .028" Ø max.

**Universal pliers**

**Bends:** hard wire up to 1,0 mm / .039" Ø max.  
hard profiled wires up to 1,3 x 0,65 mm  
/ .051" x .026" max.

**Cuts:** hard wire up to 0,7 mm / .028" Ø max.

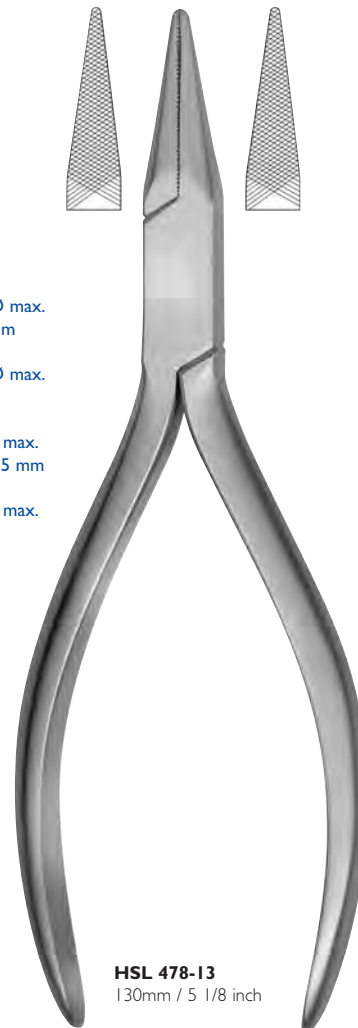
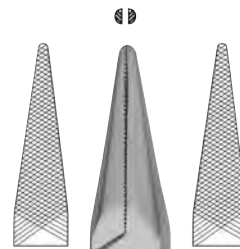

**HSL 478-13**  
130mm / 5 1/8 inch

**Flachzange**, gerieft  
für Draht bis 0,7 mm / .028" max.

**Flatnose pliers**, serrated  
for wire until 0,7 mm / .028" max.



**HSL 504-16**  
no. 177

165mm / 6 1/2 inch  
desinfizierbar / disinfestable

**Hebelseitenschneider**

für harten Draht bis 1,2mm  
/ .047" Ø max.

**Double action side nippers**  
for hard wire until 1,2mm  
/ .047" Ø max.

Sägen und Hartgipsschneidezangen  
Saws and hard plaster nippers



**HSL 672-25**  
0,25 x 3 mm



**HSL 673-12**  
0,12 x 2,8 mm

Modellsägeblätter, schnellschneidend und biegefest  
Saw blades, quick cutting with high flexural strength

Verpackungseinheit: 24 Stück  
Standard package: 24 pcs



**HSL 669-18**  
180 mm  
Abgewinkelte Säge  
Bowed model saw



**HSL 650-19**  
**Hammacher**  
190 mm  
Hartgipsschneidezange  
Hard plaster nipper

**HSL 651-00**  
Verschluß, Feder, allein  
Special lock, spring, only

**HSL 653-00**  
Schraube, allein  
Screw, only

**Vorzüge Hammacher Hartgipsschneidezange:**

- ✓ Unbeschwerliches und handliches Arbeiten durch Gewichtsersparnis
- ✓ Abrutschen der Hand in das Zangenmaul nicht möglich
- ✓ keine Klemmgefahr mehr
- ✓ bruchsicere farbige Kunststoffgriffe
- ✓ rostsicherer Edelstahl
- ✓ diese Zange kann leicht mit einer Hand geöffnet und geschlossen werden
- ✓ bequemes Arbeiten durch veränderte Schenkelstellung

**Advantages Hammacher hard plaster nipper:**

- ✓ Easy, handy working thanks to less weight
- ✓ it is impossible for the hand to slip into the bit of the forceps
- ✓ no more danger of getting caught
- ✓ unbreakable, coloured plastic handles
- ✓ non-rusting stainless steel
- ✓ these forceps can easily be opened and closed with one hand
- ✓ comfortable working thanks to altered position of the shanks

Alle mit CE gekennzeichneten Produkte sind Medizinprodukte. | All products marked with CE are medical devices.

### Norm-Tray-Kassetten Norm-Tray-Cassettes

18/8

Es gibt einfach keine Alternative zu 18/8 Edelstahl...denn Norm-Tray-Kassetten und Norm-Trays aus 18/8 Edelstahl sind absolut rost- und säurebeständig. Sie verfärben sich nicht - auch nicht im Thermodesinfektor!

There is no alternative to 18/8 special steel...as Norm-Tray-Cassettes and Norm-Trays made of 18/8 special steel are absolutely corrosion- and acidproof. They do not become discoloured - not even in the thermo-disinfector.



DIN 13999  
285 x 185 x 40 mm

#### HWM 020-00

Norm-Tray-Kassette, leer, bestehend aus ungelochtem Deckelteil und **ungelochtem** Bodenteil, aus 18/8 Edelstahl  
Norm-Tray-Cassette, empty, composed of unperforated lid and **unperforated** bottom - of 18/8 special steel

#### HWM 021-00

Norm-Tray-Kassette, leer, bestehend aus ungelochtem Deckelteil und **gelochtem** Bodenteil, aus 18/8 Edelstahl  
Norm-Tray-Cassette, empty, composed of unperforated lid and **perforated** bottom - of 18/8 special steel

Einzelteile:  
Component parts:

#### HWM 022-01

Ungelochtes Deckelteil, allein, aus 18/8 Edelstahl  
Unperforated lid, only, of 18/8 special steel

#### HWM 023-02

Ungelochtes Bodenteil, allein, aus 18/8 Edelstahl  
Unperforated bottom, only, of 18/8 special steel

#### HWM 024-00

Gelochtes Bodenteil, allein, aus 18/8 Edelstahl  
Perforated bottom, only, of 18/8 special steel



#### HWM 025-00

Lagerungsrahmen für Instrumente  
Storing frame for instruments

**Die Vorteile:** ✓ Sie sind für sämtliche Sterilisationsarten geeignet, verfärben sich nicht - auch nicht im Thermodesinfektor, sind absolut rost- und säurebeständig, leicht zu pflegen und wertbeständig, einfach zu identifizieren durch Farbpunkte, es gibt verschiedene Variationsmöglichkeiten zwischen gelochten Bodenteilen sowie Lagerungsrahmen.

**The advantages:** ✓ They withstand all sterilization treatments, they do not become discoloured - not even in the thermo-disinfector, they are absolutely corrosion- and acidproof, the cleaning is easy - they are of stable value, easy identification by marking points, different variation possibilities between perforated and unperforated bottoms and storing frames.

Instrumenten-Halterung, Sterilisier- und Waschkassetten  
Instrument holder, sterilising and washing cassettes

**ULTRALIGHT Kassetten – besonders für RDG konzipiert**

- ✓ sehr stark, aber leicht und geeignet für alle Desinfektions- und Reinigungsmittel sowie alle Sterilisationsverfahren
- ✓ aus Edelstahl mit Silikon-Einsätze, die die meisten Instrumente sicher halten
- ✓ mit abnehmbarer Abdeckung und einer Verriegelung, die leicht zu bedienen ist

**ULTRALIGHT Cassettes – especially designed for washer disinfectors**

- ✓ very strong but light and suitable for all disinfection and cleaning solutions as well as all sterilisation processes
- ✓ made of stainless steel with silicone inserts to hold most instruments securely
- ✓ with removable cover and an locking system which is easily to use

ULTRALIGHT

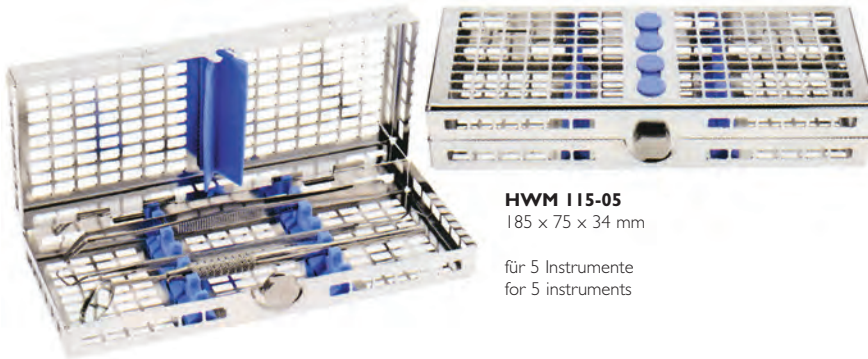

**HWM 115-05**  
185 x 75 x 34 mm

für 5 Instrumente  
for 5 instruments



**HWM 116-10**  
185 x 140 x 34 mm

für 10 Instrumente  
for 10 instruments



**HWM 117-12**  
280 x 180 x 34 mm

für 12 Instrumente  
for 12 instruments

### Instrumenten-Halterung, Sterilisier- und Waschkassetten Instrument holder, sterilising and washing cassettes

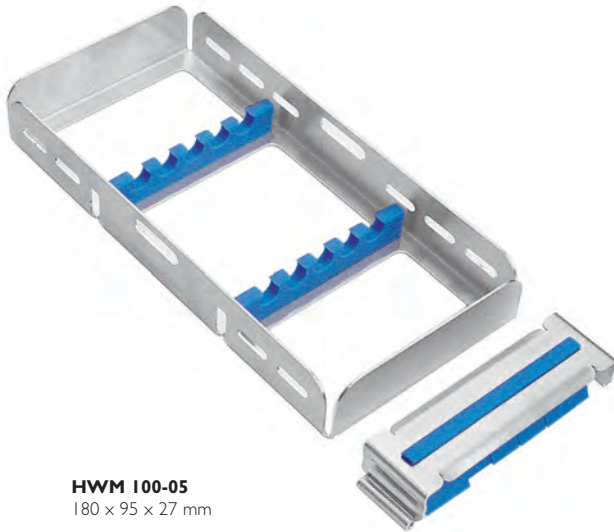

**HWM 100-05**  
180 x 95 x 27 mm

**Instrumentenhalterung - rostfreier Stahl und Silikon**

- selbsthaltender und entfernbarer Silikonstreifen
- für 5 Instrumente
- ideal für Ultraschallbäder; Reinigungs- und Desinfektionsgeräte
- für Steribeutel geeignet

**Instrument holder – stainless steel and silicone**

- self locking and removable silicone strip
- for 5 instruments
- ideal for ultrasonic baths, cleaners, disinfectors
- can be placed in autoclave pouches



**HWM 105-09**  
180 x 140 x 25 mm

**Instrumentenhalterung – rostfreier Stahl und Silikon**

- für 10 Instrumente
- kann mit jeder bekannten Desinfektionslösung verwendet werden
- beständig gegen alle Sterilisations- und Reinigungsprozesse

**Instrument holder – stainless steel and silicone**

- for 10 instruments
- can be used with any known disinfection solution
- resistant to any sterilisation and cleaning process

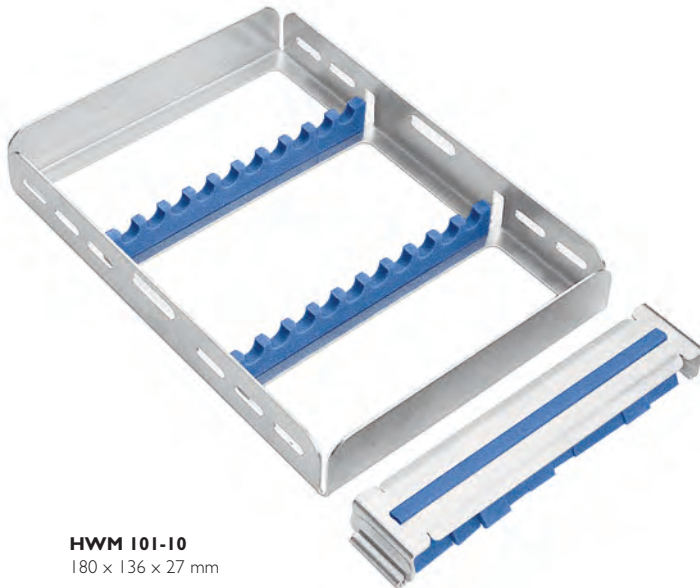

**HWM 101-10**  
180 x 136 x 27 mm

**Instrumentenhalterung - rostfreier Stahl und Silikon**

- selbsthaltender und entfernbarer Silikonstreifen
- für 10 Instrumente
- ideal für Ultraschallbäder; Reinigungs- und Desinfektionsgeräte
- für Steribeutel geeignet

**Instrument holder – stainless steel and silicone**

- self locking and removable silicone strip
- for 10 instruments
- ideal for ultrasonic baths, cleaners, disinfectors
- can be placed in autoclave pouches



**HWM 107-05**  
180 x 60 x 25 mm

**Instrumentenhalterung - rostfreier Stahl und Silikon**

- für 5 Instrumente
- mit blauem Silikon
- sterilisierbar

**Instrument holder – stainless steel and silicone**

- for 5 instruments
- with blue silicone
- sterilizable

Instrumente für Reinigung & Pflege  
Instruments for cleaning & care

Einmalgebrauch  
Disposable



**HWSZ 997-12**  
12 ml  
CE



**HWM 106-22**  
280 x 184 x 28 mm

**Instrumentenhalterung – rostfreier Stahl und Silikon**

- für 22 Instrumente
- kann mit jeder bekannten Desinfektionslösung verwendet werden

**Instrument holder – stainless steel and silicone**

- for 22 instruments
- can be used with any known disinfection solution

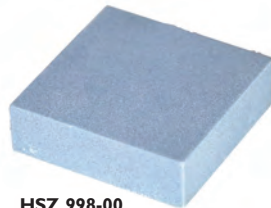

**HSZ 998-00**  
Kondenside- und  
Korrosionsradierer für alle  
mattierten Instrumente



**HSM 190-01**  
Handwaschbürste  
Aseptic nailbrush



**HSS 001-00**  
2,8 x 19,0 mm  
Spitzenschutz, Silikon, grün  
Einmalgebrauch  
(1 VE = 100 Stück)  
Tip protection, silicone, green  
Disposable  
(1 unit = 100 pcs.)



**HSS 002-00**  
3,2 x 25,4 mm  
Spitzenschutz, Silikon, pink  
(1 VE = 100 Stück)  
Tip protection, silicone, pink  
(1 unit = 100 pcs.)



**HSS 003-00**  
5,0 x 25,0 mm  
Spitzenschutz, Silikon, gelb  
(1 VE = 100 Stück)  
Tip protection, silicone, yellow  
(1 unit = 100 pcs.)



**HSS 004-00**  
2,0 x 9,0 x 25,0 mm  
Spitzenschutz, Silikon, orange  
(1 VE = 100 Stück)  
Tip protection, silicone, orange  
(1 unit = 100 pcs.)



**HSS 006-00**  
25,0 x 25,0 mm  
Spitzenschutz, Silikon, orange  
(1 VE = 50 Stück)  
Tip protection, silicone, orange  
(1 unit = 50 pcs)



**HSS 005-00**  
2,0 x 16,0 x 25,0 mm  
Spitzenschutz, Silikon, braun  
(1 VE = 100 Stück)  
Tip protection, silicone, brown  
(1 unit = 100 pcs)

**Ölstift**

- ✓ synthetisches Pflegeöl
- ✓ dampfdurchlässig und hochtemperaturstabil bis 260° C
- ✓ geruchslos, transparent und silikonfrei
- ✓ hinterlässt keine braunen Verfärbungen auf den Instrumenten
- ✓ punktgenaue Dosierung durch das Sicherheits- / Anti-Tropf-Ventil

**Oil pen**

- ✓ synthetic maintenance oil
- ✓ vapour permeable and high temperature stability up to 260 ° C
- ✓ odourless, transparent and free of silicone
- ✓ does not leave any brown stains on the instruments
- ✓ precise dosage by the safety / anti-drip valve



**HWM 107-05**  
180 x 60 x 25 mm  
Sterilisier- und Waschkassetten  
(für 5 Instrumente - mit blauem Silikon - sterilisierbar)  
Sterilising and washing cassettes  
(for 5 instruments - with blue silicone - sterilizable)



**HSJ 140-04**  
fig. 4  
22 mm  
CE

**“HAMSO”-Mundspiegel**

- ✓ ( 1 Verpackungseinheit = 12 Stück)
- ✓ absolut rostsicher, geeignet für alle Reinigungs- und Sterilisationsarten

**“HAMSO” mouth mirrors**

- ✓ ( 1 package = 12 pcs.)
- ✓ absolutely non-rusting, suitable for all kinds of cleaning and sterilization



**HSJ 102-00**  
Mundspiegelgriffe aus rostfreiem Stahl, massiv  
Mouth mirror handles from stainless steel, solid  
CE



**HSC 012-05**  
fig. 5  
**London-College**  
Zahnpinzetten aus rostfreiem Stahl, gerieft  
Tweezers from stainless steel, serrated  
CE



**HSG 009-00**  
**Williams**  
Taschenmesssonden  
Calibrated probes  
CE



**HSJ 004-42**  
fig. 42  
Zahnsonden, einendig, mit Rundgriff  
Probes and explorers, single ended, with round handle  
CE

Alle mit CE gekennzeichneten Produkte sind Medizinprodukte. | All products marked with CE are medical devices.



## HSJ 180-06

Parodontose Untersuchungsset bestehend aus den folgenden Instrumenten:  
Periodontitis examination set consisting of the following instruments:

## Instrumentensätze Instruments sets

11

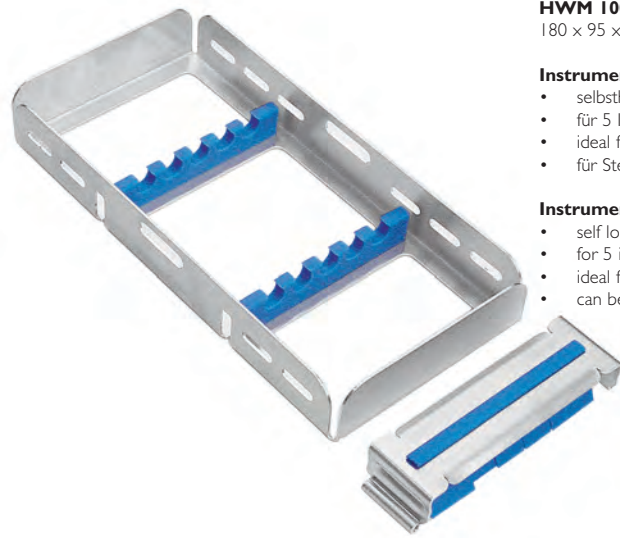

**HWM 100-05**  
180 x 95 x 27 mm

### Instrumentenhalterung - rostfreier Stahl und Silikon

- selbsthaltender und entfernbarer Silikonstreifen
- für 5 Instrumente
- ideal für Ultraschallbäder, Reinigungs- und Desinfektionsgeräte
- für Steribeutel geeignet

### Instrument holder – stainless steel and silicone

- self locking and removable silicone strip
- for 5 instruments
- ideal for ultrasonic baths, cleaners, disinfectors
- can be placed in autoclave pouches



**HSJ 140-04**  
fig. 4  
22 mm  
CE

### “HAMSO”-Mundspiegel

- ✓ (1 Verpackungseinheit = 12 Stück)
- ✓ absolut rostsicher, geeignet für alle Reinigungs- und Sterilisationsarten

### “HAMSO” mouth mirrors

- ✓ (1 package = 12 pcs.)
- ✓ absolutely non-rusting, suitable for all kinds of cleaning and sterilization



**HSJ 102-00**  
Mundspiegelgriffe aus rostfreiem Stahl, massiv  
Mouth mirror handles from stainless steel, solid  
CE

**HSC 012-05**  
fig. 5  
**London-College**  
Zahnpinzetten aus rostfreiem Stahl, gerieft  
Tweezers from stainless steel, serrated  
CE

**HSG 008-00**  
**WHO**  
Taschenmesssonde  
Calibrated probe  
CE



**HSJ 004-42**  
fig. 42  
Zahnsonden, einendig, mit Rundgriff  
Probes and explorers, single ended, with round handle  
CE



**HSG 012-00**  
**Nabers**  
CE

Alle mit CE gekennzeichneten Produkte sind Medizinprodukte. | All products marked with CE are medical devices.

**Instrumentensätze  
Instruments sets**

**HSJ 181-05**

Set zur chirurgischen Nahtentfernung bestehend aus den folgenden Instrumenten:  
Surgical suture removal set consisting of the following instruments:



**HWM 107-05**  
180 x 60 x 25 mm  
Sterilisier- und Waschkassetten  
(für 5 Instrumente - mit blauem Silikon - sterilisierbar)  
Sterilising and washing cassettes  
(for 5 instruments - with blue silicone - sterilizable)



**HR Front  
Rhodium**

**HSJ 136-05**  
fig. 5  
24 mm  
CE



**„HAMSO“ Front-Mundspiegel  
frontverspiegelt, plan**

- ✓ 1 Stück
- ✓ Sehr helles, klares Bild – lichtstark
- ✓ Reflexion über 90 %
- ✓ Farbtreu
- ✓ Hohe Kratzfestigkeit
- ✓ Für alle gängigen Desinfektionen und Sterilisationsarten geeignet
- ✓ Temperaturbeständig bis 200°C / 390°F

**„HAMSO“ Front Mouth Mirrors  
Front surface, plane**

- ✓ 1 piece
- ✓ Very bright and clear picture
- ✓ Reflection over 90 %
- ✓ Colour fidelity
- ✓ Highly scratch-resistant
- ✓ Suitable for all usual kinds of disinfection and sterilisation
- ✓ Temperature-resistant up to 200°C/390°F



**HSJ 102-00**  
Mundspiegelgriffe aus rostfreiem Stahl, massiv  
Mouth mirror handles from stainless steel, solid  
CE



**HSC 012-05**  
fig. 5  
**London-College**  
Zahnpinzetten aus rostfreiem Stahl, gerieft  
Tweezers from stainless steel, serrated  
CE



**HSB 287-11  
Spencer**  
115 mm  
Nahtschere, abgewinkelt  
Suture scissors, angled  
CE



**HSJ 004-42**  
fig. 42  
Zahnsonden, einendig, mit Rundgriff  
Probes and explorers, single ended, with round handle  
CE



**HWM 106-22**  
280 x 184 x 28 mm

**Instrumentenhalterung – rostfreier Stahl und Silikon**

- für 22 Instrumente
- kann mit jeder bekannten Desinfektionslösung verwendet werden

**Instrument holder – stainless steel and silicone**

- for 22 instruments
- can be used with any known disinfection solution



**HSJ 136-05**  
fig. 5  
24 mm  
CE

**„HAMSO“ Front-Mundspiegel**  
frontverspiegelt, plan

- ✓ 1 Stück
- ✓ Sehr helles, klares Bild – lichtstark
- ✓ Reflexion über 90 %
- ✓ Farbtreu
- ✓ Hohe Kratzfestigkeit
- ✓ Für alle gängigen Desinfektionen und Sterilisationsarten geeignet
- ✓ Temperaturbeständig bis 200°C / 390°F

**„HAMSO“ Front Mouth Mirrors**  
Front surface, plane

- ✓ 1 piece
- ✓ Very bright and clear picture
- ✓ Reflection over 90 %
- ✓ Colour fidelity
- ✓ Highly scratch-resistant
- ✓ Suitable for all usual kinds of disinfection and sterilisation
- ✓ Temperature-resistant up to 200°C/390°F



**HSJ 102-00**  
Mundspiegelgriffe aus rostfreiem Stahl, massiv  
Mouth mirror handles from stainless steel, solid  
CE



**HSC 012-05**  
fig. 5  
**London-College**  
Zahnpinzetten aus rostfreiem Stahl, gerieft  
Tweezers from stainless steel, serrated  
CE



**HSB 808-16**  
160 mm  
Skalpellohne  
Scalpel handle  
CE



**HSK 008-03**  
fig. PR-3S  
**Prichard**  
210 mm  
sterilisierbar / sterilizable  
CE  
Raspatorien  
Raspatories



**HSB 048-13**  
**Goldman-Fox**  
130 mm  
Gingivektomie-Schere gezahnt, gerade  
Gingivectomy scissors sawedge, straight  
CE



**HSC 230-12**  
**Adson**  
120 mm  
Feine Pinzetten  
Delicate forceps  
CE



**HSE 016-12**  
**Micro-Halsted**  
125 mm  
Mikro-Klemme, sehr fein, gerade  
Micro forceps, very delicate, straight  
CE



*spitz - spitz*  
*sharp - sharp*

**HSB 391-11**  
110 mm  
**OP-Spezial-Scheren**  
Zahnfleischscheren, gebogen  
**Scissors OP-special**  
Gum scissors, curved  
CE



**HSD 238-15**  
**Crile-Wood**  
150 mm  
Nadelhalter  
Needleholder  
CE



**HSF 091-14**  
**Cawood-Minnesota**  
140 mm  
Wangen- und Lippenabhalter  
Cheek and lip retractor  
CE



**HSK 041-02**  
*fig. 2 (86)*  
**Lucas**  
170 mm  
Raspatorium  
Raspatory  
CE

Alle mit CE gekennzeichneten Produkte sind Medizinprodukte. | All products marked with CE are medical devices.

Endodontie Basis Set bestehend aus den folgenden Instrumente:  
Endodontic basic set consisting of the following instruments:



**HWM 106-22**  
280 x 184 x 28 mm

**Instrumentenhalterung – rostfreier Stahl und Silikon**

- für 22 Instrumente
- kann mit jeder bekannten Desinfektionslösung verwendet werden

**Instrument holder – stainless steel and silicone**

- for 22 instruments
- can be used with any known disinfection solution

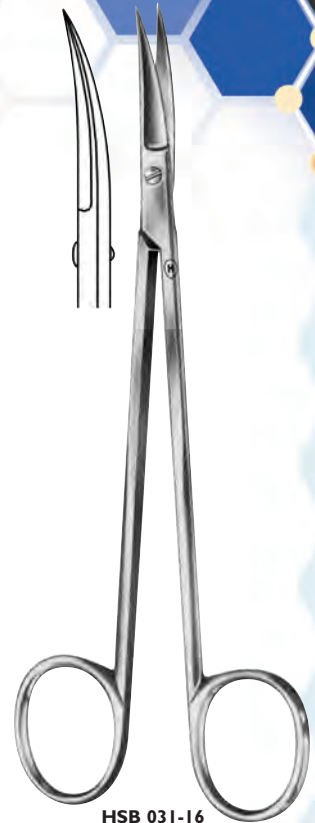

**HSB 031-16**  
**Kelly**  
160 mm  
Schere, gebogen  
Scissors, curved **CE**



**HR Front**  
**Rhodium**

**HSJ 136-05**  
fig. 5  
24 mm  
**CE**

**„HAMSO“ Front-Mundspiegel**  
frontverspiegelt, plan

- ✓ 1 Stück
- ✓ Sehr helles, klares Bild – lichtstark
- ✓ Reflexion über 90 %
- ✓ Farbtreu
- ✓ Hohe Kratzfestigkeit
- ✓ Für alle gängigen Desinfektionen und Sterilisationsarten geeignet
- ✓ Temperaturbeständig bis 200°C / 390°F

**„HAMSO“ Front Mouth Mirrors**  
Front surface, plane

- ✓ 1 piece
- ✓ Very bright and clear picture
- ✓ Reflection over 90 %
- ✓ Colour fidelity
- ✓ Highly scratch-resistant
- ✓ Suitable for all usual kinds of disinfection and sterilisation
- ✓ Temperature-resistant up to 200°C/390°F



**HSJ 102-00**  
Mundspiegelgriffe aus rostfreiem Stahl, massiv  
Mouth mirror handles from stainless steel, solid  
**CE**



**HWJ 032-16**  
Endodontie-Sonde  
Endodontic explorer  
**CE**



**HSG 024-31**  
*No. 31 L*  
Endo-Exkavator; doppelendig, mit Rundgriff  
Endo excavator; double ended, with round handle  
**CE**



**HSG 029-02**  
**GLICK 2**  
Endo-Exkavator; doppelendig, mit Rundgriff, für den einfachen Zugriff und die Entfernung von Dentin  
Endo excavator; double ended, with round handle, for easy access and removal of dentin  
**CE**



**HSC 031-15**  
155 mm  
Pinzette mit Schloß  
Forceps with ratchet **CE**

Alle mit CE gekennzeichneten Produkte sind Medizinprodukte. | All products marked with CE are medical devices.



0,3 mm

0,4 mm

0,3 mm

0,5 mm

1,0 mm

5 mm



**HWH 272-03**  
30  
CE

**HWH 272-04**  
40  
CE

**HWH 260-03**  
fig. 0  
CE

**HWH 261-05**  
fig. 1  
CE

**HWH 263-10**  
fig. 3  
CE



**HSA 513-55**  
45°  
Stieglitz  
140 mm

Zangen für Wurzel- und Knochensplitter, abgebr. Nervnadeln, festsitzende Papier- und Zelluloidspitzen, zum Einführen von Stiften  
Forceps for root and bone fragments, broken nerve broches, paper and celluloid points, pins etc.

CE

**Spreizer**

- ✓ Perfektes laterales Kondensieren durch die Abwinkelung und den Spitzenverlauf der Spreizerenden

**Spreader**

- ✓ Perfect lateral condensing due to the way it is angled and to the pointed shape of the spreader ends

**Nervkanal- und Wurzelkanal-Stopfer**

- ✓ Merkmale und Verwendungszweck:
- ✓ für die vertikale Kondensation (Verdichtung) von Guttapercha
- ✓ Markierungen in jeweiligem Abstand von 5 mm dienen als Tiefen-Meßhilfe der Pulpakammern

**Nerve-canal and root-canal condensers**

- ✓ Features and application purpose:
- ✓ for the vertical condensation of gutta-percha
- ✓ Markings 5 mm apart are used as a depth measuring aid for the pulp cavities

Alle mit CE gekennzeichneten Produkte sind Medizinprodukte. | All products marked with CE are medical devices.

Großes Restaurationsset bestehend aus den folgenden Instrumente:  
Total restorative set consisting of the following instruments:



**HWM 106-22**  
280 x 184 x 28 mm

**Instrumentenhalterung – rostfreier Stahl und Silikon**

- für 22 Instrumente
- kann mit jeder bekannten Desinfektionslösung verwendet werden

**Instrument holder – stainless steel and silicone**

- for 22 instruments
- can be used with any known disinfection solution



**HR Front**  
**Rhodium**

**HSJ 136-05**  
fig. 5  
24 mm  
CE

**„HAMSO“ Front-Mundspiegel**  
frontverspiegelt, plan

- ✓ 1 Stück
- ✓ Sehr helles, klares Bild – lichtstark
- ✓ Reflexion über 90 %
- ✓ Farbtreu
- ✓ Hohe Kratzfestigkeit
- ✓ Für alle gängigen Desinfektionen und Sterilisationsarten geeignet
- ✓ Temperaturbeständig bis 200°C / 390°F

**„HAMSO“ Front Mouth Mirrors**  
Front surface, plane

- ✓ 1 piece
- ✓ Very bright and clear picture
- ✓ Reflection over 90 %
- ✓ Colour fidelity
- ✓ Highly scratch-resistant
- ✓ Suitable for all usual kinds of disinfection and sterilisation
- ✓ Temperature-resistant up to 200°C/390°F



**HSJ 102-00**  
Mundspiegelgriffe aus rostfreiem Stahl, massiv  
Mouth mirror handles from stainless steel, solid

CE



**HSJ 004-42**  
fig. 42  
Zahnsonden, einendig, mit Rundgriff  
Probes and explorers, single ended, with round handle

CE



**HSG 014-00**

**Präparations-Tiefenmesssonde nach Dr. Göbel / Dr. Gruner**

- sicheres Messen des bestimmten, erforderlichen Zahnabtrages bei Keramikpräparationen

**Preparation depths measuring probe according to Dr. Göbel / Dr. Gruner**

- reliable measurement of tooth wear certain necessary preparations for ceramics

CE



**HWG 039-00**  
(125/126)

25	25
90	10
9	9
8	8
L	R

Exkavator; doppelendig mit Achtkantgriff  
Excavator; double-ended with octagonal handle

CE



**HWP 007-01**  
fig. 1  
Hammacher **CE**

Retraktions-, Faden- und Ringe-Stopfer, gerieft  
Nicht für geflochtenen Draht !!

Retraction, threads and rings packer, serrated  
Not for braided wire !

Geriefte Hilfsinstrumente zum leichten Anlegen der Retraktionsfäden und -Ringe.  
Serrated auxiliary instruments for easy fitting of retraction threads and rings.



**HSH 026-06**

**Platzierinstrumente**  
zum Platzieren von Unterfüllungsmaterial und Schutzlack bei Kavitätenpräparationen

**Placement instruments**  
used to place base or liner within cavity preparations **CE**



1,5 mm  
4 mm



**HWH 504-05**

Der Wiro-FILL Komposite-Planstopfer mit glatten Arbeitsenden dient einer dichten Applikation im Kavitätenboden.

The Wiro-FILL composite-condenser with flat working ends is helpful for a dense application in the cavity base.

**CE**



Ø 2,6 mm



**HWH 513-03**

Graziles Wiro-FILL Komposite-Modellierinstrument zum Anlegen von Zentralfissuren. Durch die konkave Form wird die Gestaltung der konvexen Wülste erleichtert.

Delicate Wiro-FILL composite modelling instrument for designing fissures. The concave shape facilitate the forming of convex pads.

**CE**



2,1 mm



**HWH 500-01**

Doppelendiger Wiro-FILL Komposite-Spatel für mehrere Anwendungen. Die flexiblen Arbeitsenden sind entgegengesetzt ausgerichtet und ermöglichen ein leichteres Bearbeiten mit Komposite-Materialien bei der Applikation in die Kavität durch Schaffung einer besseren Einsicht in den Arbeitsbereich.

Double-ended Wiro-FILL composite-spatula for various applications. The flexible working ends are align opposite and enable an easier preparation with composite-materials when applying into the cavity, by giving a better view into the operating area.

**CE**



**HSH 081-00**  
Ivory  
220 mm **CE**  
Amalgamträger  
Amalgam carrier

2,5 mm





**HSH 039-01**  
*fig. 1*  
**Ward**  
Modellierinstrument  
Modelling instrument



**HSH 046-01**  
*fig. 1/2-3*  
**Hollenback**  
Amalgaminstrument  
Amalgam instrument



**HWH 088-00**  
Instrument für  
plastische  
Füllungen mit  
Contrawinkel  
Plastic filling  
instrument with  
contra angle  
**CE**



**HSH 098-00**  
Zement- und  
Separierspatel  
Cement and  
separating spatulas



**HSC 012-05**  
*fig. 5*  
**London-College**  
Zahnpinzetten aus  
rostfreiem Stahl, gerieft  
Tweezers from stainless  
steel, serrated  
**CE**



**HSC 501-00**  
**Miller**  
150 mm  
Artikulationspapierpinzetten  
Forceps for articulating paper  
**CE**

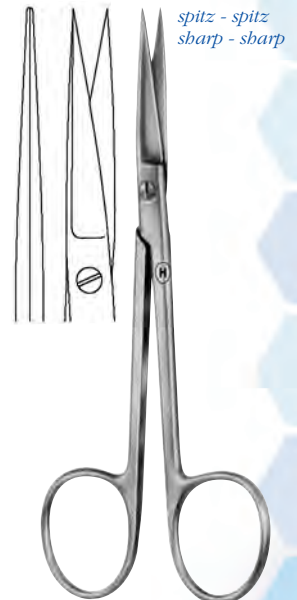

**HSB 022-12**  
**Wagner**  
120 mm  
Chirurgische Schere,  
gerade  
Operating scissors,  
straight  
**CE**

**Instrumentensätze  
Instruments sets**

**HSJ 185-14**

Set für Kronen und Brücken bestehend aus den folgenden Instrumente:  
 Crown and bridge set consisting of the following instruments:

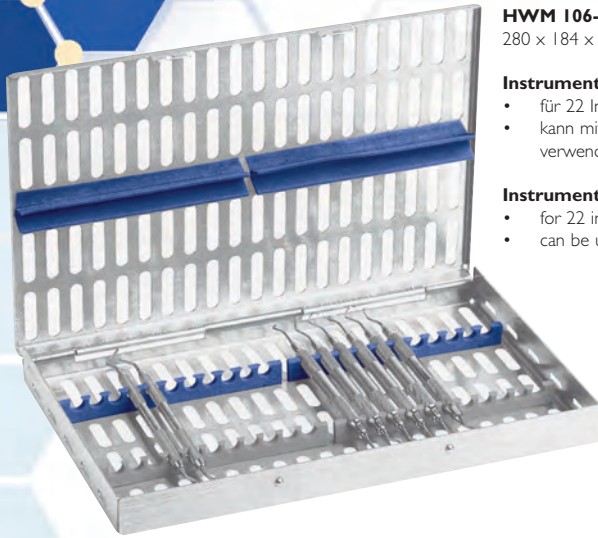

**HWM 106-22**  
 280 x 184 x 28 mm

**Instrumentenhalterung – rostfreier Stahl und Silikon**

- für 22 Instrumente
- kann mit jeder bekannten Desinfektionslösung verwendet werden

**Instrument holder – stainless steel and silicone**

- for 22 instruments
- can be used with any known disinfection solution



**HR Front  
Rhodium**

**HSJ 136-05**  
 fig. 5  
 24 mm  
 CE

**„HAMSO“ Front-Mundspiegel  
 frontverspiegelt, plan**

- ✓ 1 Stück
- ✓ Sehr helles, klares Bild – lichtstark
- ✓ Reflexion über 90 %
- ✓ Farbtreu
- ✓ Hohe Kratzfestigkeit
- ✓ Für alle gängigen Desinfektionen und Sterilisationsarten geeignet
- ✓ Temperaturbeständig bis 200°C / 390°F

**„HAMSO“ Front Mouth Mirrors  
 Front surface, plane**

- ✓ 1 piece
- ✓ Very bright and clear picture
- ✓ Reflection over 90 %
- ✓ Colour fidelity
- ✓ Highly scratch-resistant
- ✓ Suitable for all usual kinds of disinfection and sterilisation
- ✓ Temperature-resistant up to 200°C/390°F



**HSJ 102-00**  
 Mundspiegelgriffe aus rostfreiem Stahl, massiv  
 Mouth mirror handles from stainless steel, solid  
 CE



**HSJ 004-42**  
 fig. 42  
 Zahnsonden, einendig, mit Rundgriff  
 Probes and explorers, single ended, with round handle



**HSG 014-00**  
**Präparations-Tiefenmesssonde nach Dr. Göbel / Dr. Gruner**  
 • sicheres Messen des bestimmten, erforderlichen Zahnabtrages bei Keramikpräparationen  
**Preparation depths measuring probe according to Dr. Göbel / Dr. Gruner**  
 • reliable measurement of tooth wear certain necessary preparations for ceramics



**HWG 039-00**  
 (125/126)  
 25 25  
 90 10  
 9 9  
 8 8  
 L R  
 Exkavator; doppelendig mit Achtkantgriff  
 Excavator; double-ended with octagonal handle



**HWP 007-01**  
 fig. 1  
**Hammacher**

Retraktions-, Faden- und Ringe-Stopfer; gerieft  
 Nicht für geflochtenen Draht !!  
 Retraction, threads and rings packer; serrated  
 Not for braided wire !



**HSC 501-00  
Miller**  
150 mm  
Artikulationspapierpinzetten  
Forceps for articulating paper

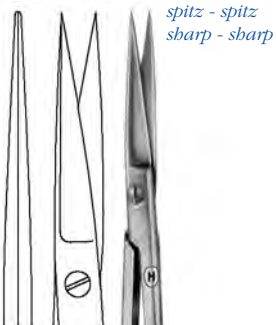

*spitz - spitz  
sbarp - sbarp*

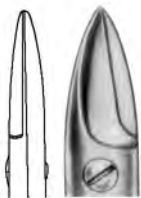

**HSC 012-05  
fig. 5  
London-College**  
Zahnpinzetten aus  
rostfreiem Stahl, gerieft  
Tweezers from stainless  
steel, serrated

CE



**HSB 648-10  
Beebee**  
100 mm  
Kronenschere, gerade  
Crown and collar scissors,  
straight



**HSB 022-12  
Wagner**  
120 mm  
Chirurgische Schere,  
gerade  
Operating scissors,  
straight

CE



**HSH 026-06**  
**Platzierinstrumente**  
zum Platzieren von  
Unterfüllungsmaterial und  
Schutzlack bei  
Kavitätenpräparationen

**Placement instruments**  
used to place base or liner  
within cavity preparations



**HSH 046-01  
fig. 1/2-3  
Hollenback**  
Amalgaminstrument  
Amalgam instrument



**HSG 339-53  
Fig. H5-33**

Sichelscaler  
Sickle scaler

CE



**HSH 098-00**  
Zement- und  
Separierspatel  
Cement and  
separating spatulas

## Instrumentensätze Instruments sets

### HSJ 186-20

Chirurgisches Implant und Sinus Lift Set bestehend aus den folgenden Instrumente:  
Surgical Implant and sinus lift set consisting of the following instruments:

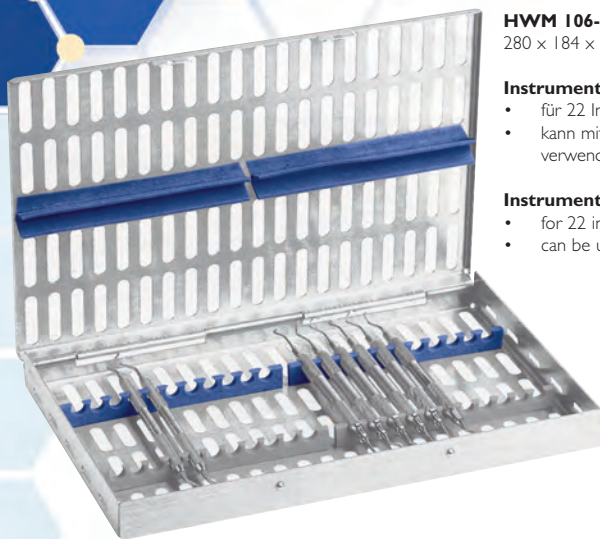

**HWM 106-22**  
280 x 184 x 28 mm

**Instrumentenhalterung – rostfreier Stahl und Silikon**

- für 22 Instrumente
- kann mit jeder bekannten Desinfektionslösung verwendet werden

**Instrument holder – stainless steel and silicone**

- for 22 instruments
- can be used with any known disinfection solution



**HR Front**  
**Rhodium**

**HSJ 136-05**  
fig. 5  
24 mm  
CE

**„HAMSO“ Front-Mundspiegel**  
frontverspiegelt, plan

- ✓ 1 Stück
- ✓ Sehr helles, klares Bild – lichtstark
- ✓ Reflexion über 90 %
- ✓ Farbtreu
- ✓ Hohe Kratzfestigkeit
- ✓ Für alle gängigen Desinfektionen und Sterilisationsarten geeignet
- ✓ Temperaturbeständig bis 200°C / 390°F

**„HAMSO“ Front Mouth Mirrors**  
Front surface, plane

- ✓ 1 piece
- ✓ Very bright and clear picture
- ✓ Reflection over 90 %
- ✓ Colour fidelity
- ✓ Highly scratch-resistant
- ✓ Suitable for all usual kinds of disinfection and sterilisation
- ✓ Temperature-resistant up to 200°C/390°F



**HSJ 102-00**  
Mundspiegelgriffe aus rostfreiem Stahl, massiv  
Mouth mirror handles from stainless steel, solid  
CE



**HSC 012-05**  
fig. 5  
**London-College**  
Zahnpinzetten aus rostfreiem Stahl, gerieft  
Tweezers from stainless steel, serrated  
CE



**HSJ 004-42**  
fig. 42  
Zahnsonden, einendig, mit Rundgriff  
Probes and explorers, single ended, with round handle  
CE



**HSG 014-00**

**Präparations-Tiefenmesssonde nach Dr. Göbel / Dr. Gruner**  
• sicheres Messen des bestimmten, erforderlichen Zahnabtrages bei Keramikpräparationen

**Preparation depths measuring probe according to Dr. Göbel / Dr. Gruner**  
• reliable measurement of tooth wear certain necessary preparations for ceramics

CE



**HSB 808-16**  
160 mm  
Skalpellgriff  
Scalpel handle  
CE



**HSC 088-15  
Semken**  
150 mm  
Feine anatomische  
Pinzetten, gerade  
Delicate dressing  
forceps, straight



**HSC 216-14**  
145 mm  
Chirurgische Pinzetten,  
gerade, schlankes Modell  
Tissue forceps, straight,  
delicate model  
CE



**HSK 033-00  
Buser**  
170 mm  
CE  
Raspatorium  
Raspatories



**HSK 250-175  
Rhodes**  
175 mm  
Meißel, Back Action  
Chisels, Back Action  
CE



**HSK 008-03  
fig. PR-3S  
Prichard**  
210 mm  
sterilisierbar /  
sterilizable  
CE  
Raspatorien  
Raspatories



**HSK 041-02  
fig. 2 (86)  
Lucas**  
170 mm  
Raspatorium  
Raspatory  
CE

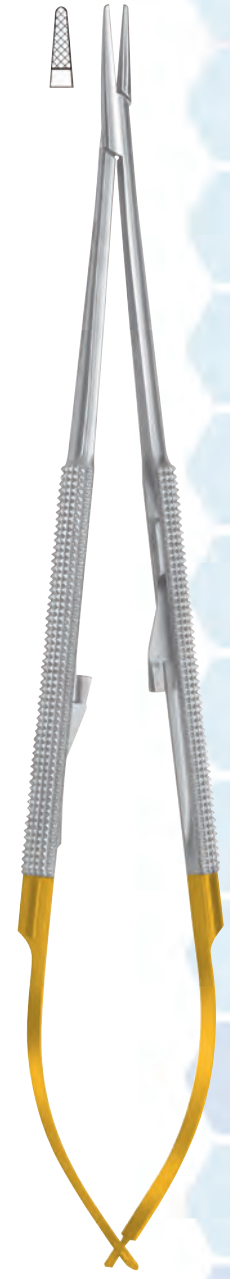

**HSD 336-18  
Barraquer**  
180 mm / 7 inch  
Mikro-Nadelhalter  
Micro needle holder  
CE

*Master  
line*

Ø 4,5 mm  
8-10-13-15-16-18 mm



**HSK 012-24**  
fig. 2-4  
**Molt**  
190 mm  
Raspatorium  
Raspatory  
CE



**HSK 506-00**  
3 mm  
Sinus Membrane Kürette /  
Elevatorium, fein, 45°, scharf  
Sinus Membrane curettes /  
elevator, fine, 45°, sharp  
CE

8-10-13-15-16-18 mm  
Ø 3,5 mm

**HSK 397-19**  
190 mm  
Ø 4,5 mm / Ø 3,5 mm

8 - 10 - 13 - 15 - 16 - 18 mm  
Granulatstopfer  
Granulate plugger



**HSK 410-01**  
Flexible Sinus Lift Küretten  
Flexible sinus lift curettes  
CE

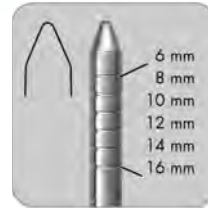

6 mm  
8 mm  
10 mm  
12 mm  
14 mm  
16 mm



**HSK 462-20**  
160 mm  
Ø 2,0 mm  
Osteotome  
Osteotomes  
CE



spitz - spitz  
sbarp - sbarp

**HSB 392-11**  
**La Grange**  
115 mm  
S-förmig gebogen  
curved like a S

CE  
**OP-Spezial-Schere**  
Scissors OP-special



**HSF 091-14**  
**Cawood-Minnesota**  
140 mm  
Wangen- und Lippenabhalter  
Cheek and lip retractor  
CE

Alle mit CE gekennzeichneten Produkte sind Medizinprodukte. | All products marked with CE are medical devices.

## HSJ 187-11

Mikrochirurgisches Basis Set bestehend aus:  
Micro surgical basis set consisting of:

## Instrumentensätze Instruments sets

11



**HWM 106-22**  
280 x 184 x 28 mm

**Instrumentenhalterung – rostfreier Stahl und Silikon**

- für 22 Instrumente
- kann mit jeder bekannten Desinfektionslösung verwendet werden

**Instrument holder – stainless steel and silicone**

- for 22 instruments
- can be used with any known disinfection solution



**HR Front**  
**Rhodium**

**HSJ 136-05**  
fig. 5  
24 mm  
CE

**„HAMSO“ Front-Mundspiegel**  
frontverspiegelt, plan

- ✓ 1 Stück
- ✓ Sehr helles, klares Bild – lichtstark
- ✓ Reflexion über 90 %
- ✓ Farbtreu
- ✓ Hohe Kratzfestigkeit
- ✓ Für alle gängigen Desinfektionen und Sterilisationsarten geeignet
- ✓ Temperaturbeständig bis 200°C / 390°F

**„HAMSO“ Front Mouth Mirrors**  
Front surface, plane

- ✓ 1 piece
- ✓ Very bright and clear picture
- ✓ Reflection over 90 %
- ✓ Colour fidelity
- ✓ Highly scratch-resistant
- ✓ Suitable for all usual kinds of disinfection and sterilisation
- ✓ Temperature-resistant up to 200°C/390°F



**HSJ 102-00**  
Mundspiegelgriffe aus rostfreiem Stahl, massiv  
Mouth mirror handles from stainless steel, solid  
CE



**HSG 014-00**  
**Präparations-Tiefenmesssonde nach Dr. Göbel / Dr. Gruner**  
• sicheres Messen des bestimmten, erforderlichen Zahnabtrages bei Keramikpräparationen  
CE

**Preparation depths measuring probe according to Dr. Göbel / Dr. Gruner**  
• reliable measurement of tooth wear certain necessary preparations for ceramics  
CE



**HSB 808-16**  
160 mm  
Skalpellegriff  
Scalpel handle  
CE



**HSF 091-14**  
**Cawood-Minnesota**  
140 mm  
Wangen- und Lippenabhalter  
Cheek and lip retractor  
CE

Alle mit CE gekennzeichneten Produkte sind Medizinprodukte. | All products marked with CE are medical devices.



**HSC 252-17**  
175 mm / 7 inch  
**Gerald**  
Mikro-Pinzette, chirurgisch, gerade  
Micro tissue forceps, straight  
CE



**HWK 005-24**  
*fig. 24GSP*  
175 mm  
sterilisierbar / sterilizable  
CE  
Raspatorien  
Raspatories

*scharf*  
*sharp*



**HSK 011-09**  
*fig. 9*  
**Molt**  
190 mm  
sterilisierbar / sterilizable  
CE

Raspatorien, zum Abhalten-  
und Zurückhalten des  
Mucoperiostlappens  
Raspatories, for retracting  
and reflecting the  
mucoperiosteum



**HSD 314-18**  
**Castroviejo**  
180 mm  
Mikro-Nadelhalter  
Micro needle holder  
CE



**HSB 391-10**  
105 mm  
Zahnfleissscheren, gebogen  
Gum scissors, curved  
CE  
**OP-Spezial-Schere**  
**Scissors OP-special**

**HSC 491-15**  
150 mm  
Nahtpinzette, gebogen  
Suture forceps, curved  
CE





**SGCI 050-00**  
20 cm  
Küchenschere  
Kitchen scissors



**SGCI 052-15**  
15 cm  
Haushaltsschere  
Household scissors

**SGCI 051-20**  
20 cm  
Haushaltsschere  
Household scissors

## COMFORT line Messer

- ✓ Hochwertiger Chrom-Molybdän Stahl X 50 CrMoV 15
- ✓ aus einem Stück geschmiedet
- ✓ spezial öl- und eisgehärtet
- ✓ Handabzug
- ✓ handsympatischer Griff
- ✓ nahtloser Übergang von Klinge zu Griff
- ✓ spülmaschinenfest
- ✓ höchste Rostsicherheit
- ✓ modernes Design

## COMFORT line knives

- ✓ high quality Chrome-Molybdenum steel X 50 CrMoV 15
- ✓ forged from one part
- ✓ specially oil- and ice-hardened
- ✓ hand honed
- ✓ handy handle
- ✓ seamless pass-over between blade and handle
- ✓ dishwasher-safe
- ✓ highest stainless
- ✓ modern design



SGCI 109-00

### Messerblock mit 6 Teilen, Natur

Inhalt: Spickmesser 9 cm  
Schinkenmesser 15 cm  
Ausbeinmesser 15 cm  
Brotmesser 23 cm  
Kochmesser 20 cm  
Wetzstahl 26 cm

### Knife block set 6 pcs., natural

Contents: Paring knife 9 cm  
Ham slicer 15 cm  
Boning knife 15 cm  
Bread knife 23 cm  
Chef's knife 20 cm  
Sharpening steel 26 cm

### SGCI 100-09

9 cm  
Gemüsemesser  
Paring knife



### SGCI 101-09

9 cm  
Officemesser  
Fluting knife



### SGCI 102-13

13 cm  
Tomatenmesser  
Tomato knife



### SGCI 103-15

15 cm  
Schinkenmesser  
Ham slicer

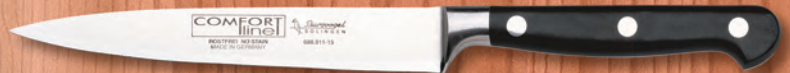

### SGCI 104-20

20 cm  
Schinkenmesser  
Ham slicer



### SGCI 105-23

23 cm  
Brotmesser  
Bread knife

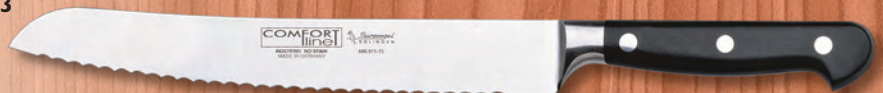

### SGCI 106-15

15 cm  
Kochmesser  
Chef's knife



### SGCI 107-20

20 cm  
Kochmesser  
Chef's knife





## SGCI 115-00

### Messerblock mit 7 Teilen, Natur

Inhalt: Spickmesser 9 cm  
Schinkenmesser 20 cm  
Fleischgabel 15 cm  
Brotmesser 23 cm  
Kochmesser 20 cm  
Wetzstahl 26 cm  
Allzweckschere

### Knife block set 7 pcs., natural

Contents: Paring knife 9 cm  
Ham slicer 20 cm  
Meat fork 15 cm  
Bread knife 23 cm  
Chef's knife 20 cm  
Sharpening steel 26 cm  
Universal scissors

COMFORT  
line



## SGCI 110-12

12 cm  
Buntschneidemesser  
Decorating knife



## SGCI 111-14

14 cm  
Käsemesser  
Cheese knife



## SGCI 113-15

14 cm  
Ausbeinmesser; flexibel  
Boning knife, flexible



## SGCI 114-18

18 cm  
Filiermesser; flexibel  
Filletting knife, flexible



## SGCI 112-31

31 cm  
Lachsmesser  
Salmon knife

## COMFORT line Messer

- ✓ Hochwertiger Chrom-Molybdän Stahl X 50 CrMoV 15
- ✓ aus einem Stück geschmiedet
- ✓ spezial öl- und eisgehärtet
- ✓ Handabzug
- ✓ handsympatischer Griff
- ✓ nahtloser Übergang von Klinge zu Griff
- ✓ spülmaschinenfest
- ✓ höchste Rostsicherheit
- ✓ modernes Design

## COMFORT line knives

- ✓ high quality Chrome-Molybdenum steel X 50 CrMoV 15
- ✓ forged from one part
- ✓ specially oil- and ice-hardened
- ✓ hand honed
- ✓ handy handle
- ✓ seamless pass-over between blade and handle
- ✓ dishwasher-safe
- ✓ highest stainless
- ✓ modern design



**SGCI 108-00**  
Kochbesteck  
Cooking set



**SGCI 116-06**  
Steakmessersatz 6tlg.  
Steak knife set 6 pcs.



COMFORT line



**SGCI 117-10**  
10 cm  
Kochmesser  
Chef's knife



**SGCI 118-18**  
18 cm  
Japankochmesser mit Kulle  
Japanese chef's knife with grooved edge



**SGCI 119-13**  
13 cm  
Kräutermesser  
Knife for herbs



**SGCI 130-09**  
9 cm  
Gemüsemesser  
Paring knife



**SGCI 131-13**  
13 cm  
Brötchenmesser  
Bread knife



**SGCI 132-14**  
14 cm  
Käsemesser  
Cheese knife



**SGCI 133-13**  
13 cm  
Tomatenmesser  
Tomato knife



**SGCI 134-13**  
13 cm  
Kräutermesser  
Herb knife



**SGCI 135-15**  
15 cm  
Ausbeinmesser; flexibel  
Boning knife, flexible

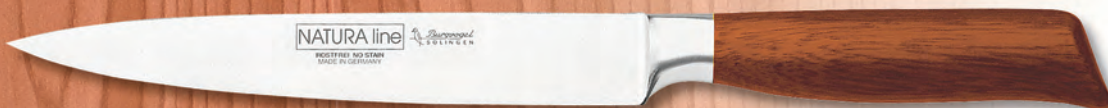

**SGCI 136-18**  
18 cm  
Fillermesser; flexibel  
Filleting knife, flexible



**SGCI 137-31**  
31 cm  
Lachsmesser  
Salmon knife

## NATURA Line Messer

- ✓ Hochwertiger Chrom-Molybdän Stahl X 50 CrMoV 15
- ✓ aus einem Stück geschmiedet
- ✓ spezial öl- und eisgehärtet
- ✓ Handabzug
- ✓ handsympatischer Griff
- ✓ nahtloser Übergang von Klinge zu Griff
- ✓ elegante Griffe aus Satine Rotholz
- ✓ höchste Rostsicherheit
- ✓ modernes Design

## NATURA Line knives

- ✓ high quality Chrome-Molybdenum steel X 50 CrMoV 15
- ✓ forged from one part
- ✓ specially oil- and ice-hardened
- ✓ hand honed
- ✓ handy handle
- ✓ seamless pass-over between blade and handle
- ✓ elegant handles made from Satine redwood
- ✓ highest stainless
- ✓ modern design

## NATURA Line Messer

- ✔ Hochwertiger Chrom-Molybdän Stahl X 50 CrMoV 15
- ✔ aus einem Stück geschmiedet
- ✔ spezial öl- und eisgehärtet
- ✔ Handabzug
- ✔ handsympatischer Griff
- ✔ nahtloser Übergang von Klinge zu Griff
- ✔ elegante Griffe aus Satine Rotholz
- ✔ höchste Rostsicherheit
- ✔ modernes Design

## NATURA Line knives

- ✔ high quality Chrome-Molybdenum steel X 50 CrMoV 15
- ✔ forged from one part
- ✔ specially oil- and ice-hardened
- ✔ hand honed
- ✔ handy handle
- ✔ seamless pass-over between blade and handle
- ✔ elegant handles made from Satine redwood
- ✔ highest stainless
- ✔ modern design



**SGCI 138-15**  
15 cm  
Schinkenmesser  
Ham slicer



**SGCI 139-18**  
18 cm  
Schinkenmesser  
Ham slicer



**SGCI 140-23**  
23 cm  
Brotmesser  
Bread knife



**SGCI 141-15**  
15 cm  
Kochmesser  
Chef's knife



**SGCI 142-20**  
20 cm  
Kochmesser  
Chef's knife



**SGCI 143-15**  
15 cm  
Fleischgabel  
Meat fork



**SGCI 144-26**  
26 cm  
Wetzstahl  
Sharpening steel

NATURA  
Line



**SGCI 338-00**

**TOOL TEC**

Zange mit Drahtschneider; Feile, Säge, Schlitz- und Kreuzschlitzschraubendreher; Glasbrecher; Bitadapter mit 9 Bits, Kapselheber; Dosenöffner; Klinge und Gürteltasche

Pliers with wire cutter; file, saw, flat tip and cross tip screwdrivers, glass breaker; bit adapter with 9 bits, cap lifter; can opener, blade and belt pouch



**SGCI 330-07**

**STRUKTURA classic maxi 7**

Taschenmesser mit großer und kleiner Klinge, Dosenöffner; Kombination aus Kapselheber und Schraubendreher; Korkenzieher; Lederbohrer; Schere, Ring, Pinzette, Zahnstocher

Pocket knife with large and small blade, can opener; cap lifter and screwdriver combination, corkscrew, piercer, scissors, key ring, tweezers, toothpick



**SGCI 340-05**

**WAVE manicure**

Maniküre Etui mit Nagelschere aus rostfreiem Edelstahl, Nagelknipser; Nagelfeile mit Nagelreiniger; Pinzette, Nagelhautmesser- und schieber

Manicure set with nail scissors made of stainless steel, nail clippers, nail file with nail cleaner; tweezers, cuticle knife and cuticle pusher



### HSM 150-00

Maniküre-Etui 5-teilig, Nappaleder, schwarz  
Manicure case with 5 parts, Nappa leather; black

### HSM 150-06

Maniküre-Etui 5-teilig  
Manicure case with 5 parts





**HSM 140-13**  
130 mm  
Saphirnagelfeile  
Sapphire nail file



**HSM 139-12**  
125 mm  
Nagelreiniger  
Nail cleaner



**HSB 652-09**  
95 mm  
Nagelschere  
Nail scissors



**HSB 391-10**  
105 mm  
Schere, gebogen  
Hammacher's OP-Spezial  
Scissors, curved,  
Hammacher's OP-Special

SUPER-CUT  
SUPER-CUT



**HSM 145-01**  
90 mm  
Kombinierte Haar- und Splitterpinzette  
Combined hair and splinter forceps

Schlüsselanhänger  
Key chain



**HWL 390-00**

Abdrucklöffel  
Impression tray



**HSA 590-00**

Zahnzange  
Extracting forceps



Solingen

Katalog-Nr. Cat. No.	Abb. auf Seite Illustr. on page	Katalog-Nr. Cat. No.	Abb. auf Seite Illustr. on page	Katalog-Nr. Cat. No.	Abb. auf Seite Illustr. on page	Katalog-Nr. Cat. No.	Abb. auf Seite Illustr. on page
<b>RESORBA</b>		8023	91	PA 1021	85	HSA 073-86	18
016483HDN	86	8061D	91	PA 1024	85	HSA 080-22	18
035485HDN	86	8062D	91	PA 1025	85	HSA 081-22	18
036483HDN	86	80210	91	PA 1026	85	HSA 082-13	123
036484HDN	86	8112D	91	PA 1060	85	HSA 100-01	19
135484HDN	87	81413	91	PA 1081	85	HSA 101-02	19
135485HDN	87	8283	91	PA 1141	85	HSA 102-07	19
136483HDN	87	88061	88	PA 11416	85	HSA 103-17	19
136484HDN	87	88112	88	PA 11417	85	HSA 104-18	19
136485HDN	87	88112D	88	PA 11418	85	HSA 105-51	19
156483HDN	87	88113D	88	PA 1151	85	HSA 106-51	20
40219N	86	88141	88	PA 1158	85	HSA 107-67	20
4024N	86	88141D	88	PA 1281	85	HSA 111-13	20
40266HDN	86	88142	88	PB40201	83	HSA 113-22	20
4026N	86	88143	89	PB40204	83	HSA 114-33	20
4027N	86	881430	88	PB40602	83	HSA 115-33	20
4028N	86	881431	88	PB40605	83	HSA 116-73	21
40610N	87	881440	88	PB40613	83	HSA 120-79	21
4062HDN	87	88144	89	PB41416	83	HSA 121-49	21
4062N	87	88144D	89	PB41420	83	HSA 125-15	22 - 24
4063HDN	87	88145	89	PB41421	83	HSA 126-08	23
4063N	87	881451	88	PB41502	83	HSA 127-07	24
4083N	87	88149	89	PB41503	83	HSA 138-51	25
40918N	87	88151	89	PB41507	83	HSA 161-86	25
4111N	87	88153	89	PB41508	83	HSA 208-06	25
4112N	87	88154	89	PB41509	83	HSA 320-29	26
4113N	87	88154D	89	PB41510	83	HSA 321-30	26
4116N	87	88155	89	PB41511	83	HSA 322-37	26
41411N	87	88155D	89	PB41512	83	HSA 323-39	26
41412N	87	88156	89	PRN30204	85	HSA 324-39	26
41413HDN	87	88156D	89	PRN31103	85	HSA 325-39	26
41413N	87	88158	89	PRN31405	85	HSA 326-39	27
41432N	87	88158D	89	RD-2502	79	HSA 327-51	27
4148N	87	9062	92	RD-3503	79	HSA 330-13	27
4149N	87	9062D	92	RDF-1502	79	HSA 331-22	27
41521HDN	87	9063	92	RDF-2502	79	HSA 332-33	27
41521N	87	9091	92	RDF-3503	79	HSA 333-38	27
41535N	87	9146	92			HSA 340-01	28
6061	90	9153	92	<b>HSA</b>		HSA 341-02	28
6062	90	DB15002S	83	HSA 001-01	15	HSA 342-03	28
6063	90	DB15003S	83	HSA 004-07	15	HSA 343-04	28
6111	90	DB22001S	94	HSA 005-17	15	HSA 344-05	28
6112	90	DB23001S	94	HSA 006-18	15	HSA 345-06	28
6112D	90	DB25001S	94	HSA 010-29	15	HSA 346-07	28
6113	90	DB25002S	94	HSA 014-49	15	HSA 350-01	29
6114	90	DB25003S	94	HSA 016-51	16	HSA 351-02	29
6118	90	DB25004S	94	HSA 017-51	16	HSA 352-03	29
6142	90	DB25005S	94	HSA 019-52	16	HSA 353-04	29
6143	90	DB25006S	94	HSA 023-67	16	HSA 354-05	29
6153	90	DB25007S	94	HSA 026-89	16	HSA 355-06	29
6154	90	DB28001S	94	HSA 027-90	16	HSA 356-07	29
7027	93	DB31001S	94	HSA 050-04	17	HSA 511-55	122
7061	93	DB32001S	94	HSA 052-13	17	HSA 512-55	122
7063	93	DK-1010	78	HSA 056-22	17	HSA 513-55	122
7148	93	DK-1836	77	HSA 060-33	17	HSA 514-55	122
7184174D	91	DK-8001	77	HSA 065-46	17	HSA 517-55	122
7184202D	92	DK-9001	77	HSA 067-73	18	HSA 550-01	31
8022	91	MK 10	78	HSA 071-79	18	HSA 551-02	31

Katalog-Nr. Cat. No.	Abb. auf Seite Illustr. on page	Katalog-Nr. Cat. No.	Abb. auf Seite Illustr. on page	Katalog-Nr. Cat. No.	Abb. auf Seite Illustr. on page	Katalog-Nr. Cat. No.	Abb. auf Seite Illustr. on page
HSA 552-07	31	HSA 710-35	43	HSB 090-15	52	HSB 896-10	57
HSA 553-17	31	HSA 726-01	41	HSB 092-16	52	HSB 897-11	57
HSA 554-18	31	HSA 727-02	41	HSB 094-18	52	HSB 898-12	57
HSA 555-29	32	HSA 728-03	41	HSB 098-11	52	HSB 899-15	57
HSA 556-30	32	HSA 731-01	42	HSB 100-13	52		
HSA 557-51	32	HSA 732-02	42	HSB 102-14	52	<b>HSC</b>	
HSA 558-51	32	HSA 733-03	42	HSB 104-15	52	HSC 012-05	12
HSA 559-67	32	HSA 735-01	41	HSB 106-16	52	HSC 020-05	12
HSA 572-13	33	HSA 736-02	41	HSB 106-18	195	HSC 021-09	12
HSA 573-22	33	HSA 737-03	41	HSB 108-18	52	HSC 024-09	12
HSA 577-74	33	HSA 7500-01	42	HSB 120-14	53	HSC 025-05	13
HSA 580-79	33	HSA 750-01	42	HSB 121-14	53	HSC 031-15	123
HSA 590-00	256	HSA 7510-02	42	HSB 126-14	53	HSC 050-11	99
HSA 600-01	34	HSA 751-02	42	HSB 127-14	53	HSC 052-13	99
HSA 601-02	34	HSA 7520-03	42	HSB 128-18	53	HSC 054-14	99
HSA 602-03	34	HSA 752-03	42	HSB 284-09	96	HSC 080-12	99
HSA 605-01	34	HSA 755-01	42	HSB 286-12	96	HSC 081-15	99
HSA 605-11	37	HSA 756-02	42	HSB 287-11	96	HSC 082-12	99
HSA 606-02	34	HSA 757-03	42	HSB 300-11	53	HSC 086-12	99
HSA 606-12	37	HSA 829-00	45	HSB 301-11	53	HSC 087-12	99
HSA 607-03	34	HSA 830-18	46	HSB 310-14	53	HSC 088-15	99
HSA 607-13	37	HSA 831-18	46	HSB 314-14	53	HSC 090-15	100
HSA 622-02	34	HSA 836-18	45	HSB 390-10	54	HSC 100-15	100
HSA 623-03	34	HSA 842-18	45	HSB 391-10	54, 255	HSC 126-18	100
HSA 627-01	35	HSA 843-22	45	HSB 392-11	54	HSC 128-15	100
HSA 628-02	35			HSB 394-13	54	HSC 129-20	100
HSA 647-27	36	<b>HSB</b>		HSB 396-13	54	HSC 202-13	100
HSA 647-28	36	HSB 010-10	49	HSB 400-14	55	HSC 204-14	100
HSA 648-39	36	HSB 011-10	49	HSB 401-14	55	HSC 206-16	100
HSA 648-40	36	HSB 0140-11	54	HSB 402-16	55	HSC 214-13	100
HSA 650-01	36	HSB 014-11	49	HSB 403-16	55	HSC 215-13	100
HSA 651-02	36	HSB 0141-11	54	HSB 412-13	55	HSC 216-14	100
HSA 675-71	37	HSB 015-11	49	HSB 422-13	55	HSC 217-14	100
HSA 676-72	37	HSB 019-11	51	HSB 423-13	55	HSC 230-12	101
HSA 677-73	37	HSB 020-11	51	HSB 554-14	140	HSC 231-15	101
HSA 678-74	37	HSB 021-11	51	HSB 555-14	140	HSC 232-12	101
HSA 685-11	43	HSB 022-12	51	HSB 556-18	133	HSC 233-15	101
HSA 686-12	43	HSB 023-12	51	HSB 557-18	133	HSC 234-12	101
HSA 692-11	43	HSB 028-15	49	HSB 630-10	223	HSC 235-12	101
HSA 693-11	43	HSB 029-15	49	HSB 652-09	255	HSC 238-12	101
HSA 700-00	38	HSB 030-16	49	HSB 803-03	56	HSC 239-12	101
HSA 701-01	38	HSB 031-16	50	HSB 805-03	56	HSC 243-15	102
HSA 701-02	38	HSB 036-10	51	HSB 808-16	56	HSC 244-18	102
HSA 702-02	38	HSB 039-16	50	HSB 809-16	56	HSC 250-17	102
HSA 703-03	38	HSB 041-17	50	HSB 815-10	56	HSC 251-17	102
HSA 704-04	38	HSB 046-11	50	HSB 816-11	56	HSC 252-17	102
HSA 705-01	39	HSB 047-11	50	HSB 817-12	56	HSC 253-17	102
HSA 705-02	39	HSB 048-13	50	HSB 818-15	56	HSC 261-15	139
HSA 705-03	39	HSB 049-13	50	HSB 819-15	56	HSC 267-15	139
HSA 705-04	39	HSB 070-11	52	HSB 820-04	57	HSC 491-15	96
HSA 7060-03	44	HSB 072-13	52	HSB 826-18	57	HSC 501-00	184
HSA 706-01	40	HSB 074-14	52	HSB 827-19	57	HSC 519-17	223
HSA 706-02	40	HSB 076-15	52	HSB 828-20	57		
HSA 707-01	40	HSB 078-16	52	HSB 829-21	57	<b>HSD</b>	
HSA 707-02	40	HSB 080-18	52	HSB 830-22	57	HSD 004-14	70
HSA 708-01	40	HSB 084-11	52	HSB 831-23	57	HSD 005-14	70
HSA 708-02	40	HSB 086-13	52	HSB 832-24	57	HSD 009-14	70
HSA 710-28	43	HSB 088-14	52	HSB 833-25	57	HSD 030-15	70

Katalog-Nr. Cat. No.	Abb. auf Seite Illustr. on page	Katalog-Nr. Cat. No.	Abb. auf Seite Illustr. on page	Katalog-Nr. Cat. No.	Abb. auf Seite Illustr. on page	Katalog-Nr. Cat. No.	Abb. auf Seite Illustr. on page
HSD 071-13	70	HSD 482-14	76	HSG 011-12	104	HSG 329-02	117
HSD 083-15	70	HSD 483-15	76	HSG 012-00	104	HSG 329-03	117
HSD 084-15	71	HSD 484-16	76	HSG 014-00	105	HSG 329-04	117
HSD 090-14	71			HSG 016-00	105	HSG 329-05	117
HSD 091-16	71	<b>HSE</b>		HSG 017-36	105	HSG 329-06	117
HSD 097-16	71	HSE 010-09	58	HSG 020-00	161	HSG 329-07	117
HSD 098-18	71	HSE 011-09	58	HSG 024-31	121	HSG 329-08	117
HSD 124-14	74	HSE 016-12	58	HSG 024-32	121	HSG 329-09	117
HSD 126-14	74	HSE 017-12	58	HSG 024-33	121	HSG 329-10	117
HSD 127-14	74	HSE 022-12	58 + 223	HSG 025-01	160	HSG 329-11	117
HSD 128-14	74	HSE 023-12	58 + 223	HSG 025-02	160	HSG 329-12	117
HSD 170-14	71	HSE 024-14	58	HSG 025-03	160	HSG 329-13	117
HSD 179-14	72 + 96	HSE 025-14	58	HSG 025-04	160	HSG 329-14	117
HSD 179-17	72	HSE 028-12	59	HSG 025-05	160	HSG 330-67	111
HSD 205-18	72	HSE 029-12	59	HSG 025-06	160	HSG 331-04	111
HSD 218-16	72	HSE 044-14	59	HSG 025-07	160	HSG 337-04	111
HSD 227-13	72	HSE 045-14	59	HSG 025-08	160	HSG 339-53	108
HSD 229-13	72	HSE 048-14	59	HSG 025-09	160	HSG 340-02	111
HSD 236-14	72	HSE 049-14	59	HSG 026-17	159	HSG 341-04	111
HSD 237-15	73	HSE 062-13	59	HSG 027-18	159	HSG 345-04	111
HSD 238-15	73	HSE 063-13	59	HSG 028-19	159	HSG 347-18	111
HSD 243-15	73	HSE 064-14	59	HSG 029-01	121	HSG 350-12	119
HSD 246-15	73	HSE 065-14	59	HSG 029-02	121	HSG 351-35	119
HSD 247-14	73	HSE 066-16	59	HSG 030-26	161	HSG 352-56	119
HSD 248-16	73	HSE 067-16	59	HSG 031-27	161	HSG 353-78	119
HSD 255-15	73	HSE 300-08	60	HSG 032-28	161	HSG 354-91	120
HSD 256-18	73	HSE 302-13	60	HSG 033-29	161	HSG 355-11	120
HSD 310-14	74			HSG 043-81	161	HSG 356-13	120
HSD 314-18	75	<b>HSF</b>		HSG 050-00	108	HSG 357-15	120
HSD 316-18	75	HSF 048-01	47	HSG 051-00	108	HSG 358-17	120
HSD 317-18	75	HSF 048-02	47	HSG 075-01	108	HSG 360-12	115
HSD 336-18	75, 96 + 139	HSF 050-01	61	HSG 076-02	108	HSG 361-34	115
HSD 338-18	75	HSF 051-02	61	HSG 077-03	108	HSG 362-56	115
HSD 430-10	76	HSF 052-03	61	HSG 078-04	108	HSG 363-78	115
HSD 431-11	76	HSF 053-04	61	HSG 203-00	108	HSG 364-91	115
HSD 432-12	76	HSF 054-05	61	HSG 210-12	114	HSG 365-11	116
HSD 433-13	76	HSF 080-00	61	HSG 211-34	114	HSG 366-13	116
HSD 434-14	76	HSF 081-01	61	HSG 212-56	114	HSG 367-15	116
HSD 435-15	76	HSF 082-02	61	HSG 213-78	114	HSG 368-17	116
HSD 436-16	76	HSF 083-03	61	HSG 214-91	114	HSG 375-00	112
HSD 446-10	76	HSF 091-14	61 + 133	HSG 215-11	114	HSG 376-04	112
HSD 447-11	76	HSF 092-15	62 + 133	HSG 216-13	114	HSG 377-04	112
HSD 448-12	76	HSF 093-15	62	HSG 217-15	114	HSG 378-04	112
HSD 449-13	76	HSF 093-16	62 + 133	HSG 240-37	110	HSG 379-13	112
HSD 450-14	76	HSF 094-12	62	HSG 241-51	110	HSG 380-13	113
HSD 451-15	76	HSF 095-14	62	HSG 258-01	105	HSG 381-15	113
HSD 452-16	76	HSF 096-16	62	HSG 259-02	105	HSG 382-13	113
HSD 462-10	76	HSF 100-01	63	HSG 262-00	58	HSG 383-56	113
HSD 463-11	76	HSF 100-02	63	HSG 268-00	58	HSG 385-78	119
HSD 464-12	76	HSF 106-02	105	HSG 285-10	110		
HSD 465-13	76	HSF 108-00	106	HSG 286-01	110	<b>HSH</b>	
HSD 466-14	76			HSG 287-01	110	HSH 004-02	179
HSD 467-15	76	<b>HSG</b>		HSG 288-34	110	HSH 005-03	179
HSD 468-16	76	HSG 004-00	104	HSG 289-11	110	HSH 006-04	179
HSD 478-10	76	HSG 006-00	104	HSG 291-00	106	HSH 010-00	180
HSD 479-11	76	HSG 008-00	104	HSG 297-00	106	HSH 011-01	180
HSD 480-12	76	HSG 009-00	104	HSG 300-06	128	HSH 012-02	180
HSD 481-13	76	HSG 010-00	104	HSG 329-01	117	HSH 017-12	180

Katalog-Nr. Cat. No.	Abb. auf Seite Illustr. on page	Katalog-Nr. Cat. No.	Abb. auf Seite Illustr. on page	Katalog-Nr. Cat. No.	Abb. auf Seite Illustr. on page	Katalog-Nr. Cat. No.	Abb. auf Seite Illustr. on page
HSH 021-01	180	HSH 136-00	188	HSJ 108-00	6	HSK 034-00	66
HSH 026-06	180	HSH 138-00	188	HSJ 109-01	6	HSK 040-01	65
HSH 027-01	180	HSH 138-01	188	HSJ 111-08	127	HSK 041-02	65
HSH 029-00	181	HSH 138-04	188	HSJ 114-30	140	HSK 051-01	66
HSH 029-01	181	HSH 138-05	188	HSJ 116-00	6	HSK 052-02	66
HSH 029-02	181	HSH 140-01	188	HSJ 123-00	10	HSK 053-03	66
HSH 029-04	181	HSH 141-02	188	HSJ 125-04	8	HSK 081-01	66
HSH 031-12	182	HSH 142-03	188	HSJ 126-05	8	HSK 083-03	66
HSH 035-61	182	HSH 148-00	130, 189, 191	HSJ 131-04	8	HSK 115-00	67
HSH 039-01	182	HSH 159-00	189	HSJ 132-05	8	HSK 116-01	67
HSH 043-00	182	HSH 171-01	129, 190, 192	HSJ 134-10	9	HSK 117-02	67
HSH 044-45	182	HSH 172-02	192	HSJ 135-04	8 + 128	HSK 220-14	68 + 134
HSH 045-36	182	HSH 190-00	130	HSJ 136-05	8	HSK 221-10	68
HSH 046-01	182	HSH 199-00	129 + 190	HSJ 140-04	8	HSK 222-01	68 + 134
HSH 047-30	182	HSH 200-08	130, 192, 192	HSJ 141-05	8	HSK 223-00	68
HSH 048-03	182	HSH 203-01	129, 130, 190	HSJ 142-06	8	HSK 228-40	156
HSH 053-21	183	HSH 210-00	129, 190, 192	HSJ 150-04	8	HSK 228-75	156
HSH 054-21	183	HSH 210-03	192	HSJ 151-05	8	HSK 229-40	156
HSH 055-00	183	HSH 211-01	129, 190, 192	HSJ 154-01	10	HSK 229-75	156
HSH 056-00	183	HSH 212-02	129, 190, 192	HSJ 155-02	10	HSK 250-175	109
HSH 057-01	183	HSH 212-03	192	HSJ 156-03	10	HSK 251-165	134
HSH 058-01	127	HSH 212-04	192	HSJ 157-00	10	HSK 301-01	68
HSH 058-02	127	HSH 212-10	192	HSJ 159-01	11	HSK 302-02	68
HSH 062-31	183	HSH 212-22	192	HSJ 159-02	11	HSK 338-35	132
HSH 063-22	183	HSH 213-07	129, 190, 192	HSJ 159-03	11	HSK 338-45	132
HSH 066-27	184	HSH 214-70	192	HSJ 160-00	5	HSK 338-55	132
HSH 071-00	181	HSH 215-08	129, 190, 192	HSJ 163-00	60	HSK 339-05	141
HSH 073-00	181	HSH 216-80	129, 190, 192	HSJ 164-01	60	HSK 339-06	141
HSH 074-00	181	HSH 217-14	129, 190, 192	HSJ 165-02	60	HSK 345-00	141
HSH 081-00	181	HSH 218-09	192	HSJ 180-05	230	HSK 346-00	141
HSH 089-24	186	HSH 219-21	129, 190, 192	HSJ 180-06	231	HSK 346-03	141
HSH 096-00	186			HSJ 181-05	232	HSK 346-90	141
HSH 098-00	186	<b>HSJ</b>		HSJ 182-12	233 + 234	HSK 346-92	141
HSH 101-00	186	HSJ 001-06	1	HSJ 183-13	235 + 236	HSK 347-00	141
HSH 102-00	186	HSJ 002-17	1	HSJ 184-18	237 - 239	HSK 349-00	138
HSH 106-00	186	HSJ 003-23	1	HSJ 185-14	240 + 241	HSK 380-01	44 + 138
HSH 112-01	187	HSJ 004-42	1	HSJ 186-20	242 - 244	HSK 381-02	44 + 138
HSH 113-12	187	HSJ 005-43	1	HSJ 187-11	245 + 246	HSK 382-03	44 + 138
HSH 114-06	187	HSJ 006-44	1	HSJ 203-13	63	HSK 3810-01	44
HSH 114-07	187	HSJ 008-42	13	HSJ 204-11	63	HSK 3820-02	44
HSH 115-01	187	HSJ 030-09	2	HSJ 204-90	63	HSK 3830-03	44
HSH 116-02	187	HSJ 053-05	2	HSJ 205-14	63	HSK 3840-04	44
HSH 117-03	187	HSJ 058-01	2 + 161			HSK 397-19	137
HSH 118-01	187	HSJ 064-42	5	<b>HSK</b>		HSK 398-17	137
HSH 119-02	187	HSJ 069-09	5	HSK 003-09	64	HSK 410-01	142
HSH 120-03	187	HSJ 090-01	7	HSK 004-19	64	HSK 410-02	142
HSH 121-05	187	HSJ 091-02	7	HSK 006-09	64	HSK 410-03	142
HSH 125-05	187	HSJ 092-03	7	HSK 008-03	64	HSK 410-04	142
HSH 126-06	187	HSJ 093-04	7	HSK 011-03	65	HSK 411-01	143
HSH 127-07	187	HSJ 094-05	7	HSK 011-08	64	HSK 411-02	143
HSH 128-07	188	HSJ 100-03	13	HSK 011-09	64	HSK 411-03	143
HSH 129-08	188	HSJ 100-05	14	HSK 012-24	65	HSK 411-04	143
HSH 130-09	188	HSJ 101-00	13	HSK 015-17	65	HSK 411-05	143
HSH 131-10	188	HSJ 102-00	6	HSK 018-17	66	HSK 411-06	144
HSH 132-11	188	HSJ 103-00	6	HSK 019-00	134	HSK 411-07	144
HSH 133-12	188	HSJ 104-00	6 + 144	HSK 021-23	65	HSK 411-08	144
HSH 134-13	188	HSJ 105-00	140	HSK 023-00	134	HSK 411-09	144
HSH 135-00	188	HSJ 106-00	6	HSK 033-00	66	HSK 411-10	144

Katalog-Nr. Cat. No.	Abb. auf Seite Illustr. on page	Katalog-Nr. Cat. No.	Abb. auf Seite Illustr. on page	Katalog-Nr. Cat. No.	Abb. auf Seite Illustr. on page	Katalog-Nr. Cat. No.	Abb. auf Seite Illustr. on page
HSK 411-11	145	HSK 468-37	152	HSL 164-14	195	HSL 669-18	225
HSK 411-12	145	HSK 468-42	152	HSL 169-01	195	HSL 672-25	225
HSK 411-13	145	HSK 468-50	152	HSL 170-02	195	HSL 673-12	225
HSK 411-14	145	HSK 469-20	153	HSL 172-01	195	HSL 750-00	187
HSK 411-15	145	HSK 469-27	153	HSL 173-02	195	HSL 751-00	187
HSK 412-22	154	HSK 469-32	153	HSL 175-00	195		
HSK 412-28	154	HSK 469-37	153	HSL 177-05	197	<b>HSM</b>	
HSK 412-34	154	HSK 469-42	153	HSL 177-60	197	HSM 114-18	11
HSK 412-40	154	HSK 469-50	153	HSL 177-70	197	HSM 139-12	255
HSK 413-22	155	HSK 470-20	152	HSL 177-80	197	HSM 140-13	255
HSK 413-28	155	HSK 470-27	152	HSL 183-00	196	HSM 145-01	255
HSK 413-34	155	HSK 470-32	152	HSL 184-00	196	HSM 150-00	254
HSK 413-40	155	HSK 470-37	152	HSL 185-01	196	HSM 150-06	254 + 255
HSK 461-20	149	HSK 470-42	152	HSL 186-02	196	HSM 190-01	229
HSK 461-27	149	HSK 470-50	152	HSL 187-03	196	HSM 215-01	193
HSK 461-32	149	HSK 471-20	153	HSL 192-00	197	HSM 216-01	193
HSK 461-37	149	HSK 471-27	153	HSL 193-01	197	HSM 217-01	193
HSK 461-42	149	HSK 471-32	153	HSL 194-02	197	HSM 218-01	193
HSK 461-50	149	HSK 471-37	153	HSL 194-03	197	HSM 219-01	193
HSK 461-60	149	HSK 471-42	153	HSL 195-00	197	HSM 260-28	130 + 191
HSK 462-20	146	HSK 471-50	153	HSL 195-01	197		
HSK 462-27	146	HSK 480-01	69	HSL 195-02	197	<b>HSN</b>	
HSK 462-32	146	HSK 481-01	69	HSL 195-03	197	HSN 200-08	198
HSK 462-37	146	HSK 505-00	137	HSL 196-01	197	HSN 201-10	198
HSK 462-42	146	HSK 505-02	69	HSL 206-13	196	HSN 202-13	198
HSK 462-50	146	HSK 505-90	135 + 136	HSL 206-33	196	HSN 220-08	198
HSK 462-60	146	HSK 506-00	137	HSL 211-16	196	HSN 221-10	198
HSK 463-20	150	HSK 506-90	135 + 136	HSL 219-16	222	HSN 222-13	198
HSK 463-27	150	HSK 507-00	137	HSL 231-00	222		
HSK 463-32	150	HSK 508-00	137	HSL 231-01	222	<b>HSO</b>	
HSK 463-37	150	HSK 508-03	69	HSL 231-02	222	HSO 135-12	131
HSK 463-42	150	HSK 508-90	135 + 136	HSL 231-03	222	HSO 138-62	131
HSK 463-50	150	HSK 509-90	135 + 136	HSL 233-12	220	HSO 138-63	131
HSK 463-60	150	HSK 512-00	135 + 136	HSL 234-12	220	HSO 139-64	131
HSK 464-20	147	HSK 513-02	69	HSL 235-15	220	HSO 140-65	131
HSK 464-27	147	HSK 518-00	69	HSL 236-12	221	HSO 145-04	131
HSK 464-32	147	HSK 552-03	69	HSL 237-12	221		
HSK 464-37	147	HSK 592-14	69	HSL 237-12	221	<b>HSR</b>	
HSK 464-42	147			HSL 237-12	221	HSR 002-06	4
HSK 464-50	147	<b>HSL</b>		HSL 237-12	221	HSR 006-23	4
HSK 464-60	147	HSL 023-15	215	HSL 237-12	221	HSR 015-00	176
HSK 465-20	151	HSL 024-01	215	HSL 238-15	221	HSR 016-01	176
HSK 465-27	151	HSL 025-02	215	HSL 245-00	218	HSR 017-02	176
HSK 465-32	151	HSL 026-03	215	HSL 245-12	218	HSR 030-00	159
HSK 465-37	151	HSL 027-04	215	HSL 246-00	218	HSR 031-00	159
HSK 465-42	151	HSL 028-05	215	HSL 246-15	219	HSR 032-00	159
HSK 465-50	151	HSL 027-04	215	HSL 247-00	218	HSR 033-00	159
HSK 466-20	148	HSL 050-12	216	HSL 247-10	218	HSR 100-00	109
HSK 466-27	148	HSL 051-17	216	HSL 252-15	127	HSR 501-02	170
HSK 466-32	148	HSL 052-17	216	HSL 423-12	224	HSR 501-03	170
HSK 466-37	148	HSL 054-00	216	HSL 431-15	224	HSR 502-03	170
HSK 466-42	148	HSL 060-03	216	HSL 478-13	224	HSR 503-04	170
HSK 466-50	148	HSL 062-07	216	HSL 504-16	224	HSR 508-09	170
HSK 466-60	148	HSL 108-13	217	HSL 562-06	216	HSR 509-10	170
HSK 468-20	152	HSL 109-17	217	HSL 572-00	223	HSR 512-00	170
HSK 468-27	152	HSL 112-13	217	HSL 573-00	223	HSR 514-01	170
HSK 468-32	152	HSL 115-17	217	HSL 574-00	223	HSR 550-00	5
		HSL 115-17	217	HSL 650-19	225		
		HSL 121-18	217	HSL 651-00	225		
		HSL 122-16	217	HSL 653-00	225		

Katalog-Nr. Cat. No.	Abb. auf Seite Illustr. on page	Katalog-Nr. Cat. No.	Abb. auf Seite Illustr. on page	Katalog-Nr. Cat. No.	Abb. auf Seite Illustr. on page	Katalog-Nr. Cat. No.	Abb. auf Seite Illustr. on page
<b>HSS</b>		HWC 530-14	127	HWH 048-00	174	HWH 305-01	126
HSS 001-00	229			HWH 049-00	174	HWH 306-02	126
HSS 002-00	229	<b>HWF</b>		HWH 050-00	174	HWH 311-01	126
HSS 003-00	229	HWF 020-12	60	HWH 067-12	175	HWH 312-02	126
HSS 004-00	229	HWF 021-15	60	HWH 067-28	184	HWH 316-06	126
HSS 005-00	229	HWF 033-01	48	HWH 068-12	175	HWH 500-01	162
HSS 006-00	229	HWF 033-11	48	HWH 070-12	175	HWH 501-02	162
		HWF 034-02	48	HWH 071-18	175	HWH 501-03	162
<b>HSZ</b>		HWF 034-12	48	HWH 072-21	175	HWH 502-03	162
HSZ 997-12	229	HWF 035-03	48	HWH 080-10	175	HWH 503-04	162
HSZ 998-00	229	HWF 035-13	48	HWH 081-12	175	HWH 504-05	163
		HWF 097-00	47	HWH 082-18	175	HWH 505-06	163
				HWH 083-21	175	HWH 506-07	163
<b>HTC</b>		<b>HWG</b>		HWH 088-00	175	HWH 507-08	163
HTC 033-05	131	HWG 020-00	123, 128 +	HWH 089-00	175	HWH 508-09	163
HTC 036-15	131		157	HWH 090-00	175	HWH 509-10	164
HTC 037-15	131	HWG 021-00	157	HWH 110-00	177	HWH 510-11	164
		HWG 022-00	157	HWH 111-00	177	HWH 511-12	164
<b>HTG</b>		HWG 023-00	157	HWH 118-00	177	HWH 512-00	164
HTG 064-20	107	HWG 024-00	157	HWH 122-00	177	HWH 513-01	164
HTG 065-67	107	HWG 030-00	157	HWH 123-00	177	HWH 513-02	164
HTG 066-12	107	HWG 031-00	157	HWH 125-00	177	HWH 513-03	165
HTG 067-34	107	HWG 032-00	157	HWH 126-00	177	HWH 513-04	165
HTG 068-56	107	HWG 033-00	157	HWH 145-00	178	HWH 513-05	165
HTG 115-67	107	HWG 036-00	158	HWH 146-00	178	HWH 514-01	165
HTG 116-204	107	HWG 037-00	158	HWH 186-01	178	HWH 514-02	165
HTG 117-56	107	HWG 038-00	158	HWH 187-12	178	HWH 520-01	166
		HWG 039-00	158	HWH 200-00	178	HWH 521-02	166
<b>HWB</b>		HWG 055-00	158	HWH 200-08	178	HWH 521-03	166
HWB 201-26	103	HWG 056-00	158	HWH 201-00	178	HWH 522-03	166
HWB 202-20	103	HWG 057-00	158	HWH 202-00	179	HWH 523-04	167
HWB 203-23	103	HWG 058-00	158	HWH 203-00	179	HWH 524-05	167
HWB 204-25	103	HWG 086-00	109	HWH 204-00	179	HWH 525-06	167
HWB 205-20	103	HWG 100-00	109	HWH 217-00	185	HWH 526-07	167
HWB 220-30	103	HWG 101-00	109	HWH 218-00	185	HWH 527-08	167
HWB 222-40	103	HWG 102-00	109	HWH 220-00	185	HWH 528-09	168
HWB 224-35	103			HWH 221-00	185	HWH 529-10	168
HWB 300-00	56	<b>HWH</b>		HWH 225-00	185	HWH 530-11	168
		HWH 005-02	172	HWH 226-00	185	HWH 531-12	168
<b>HWC</b>		HWH 006-03	172	HWH 227-00	185	HWH 532-00	168
HWC 016-04	12	HWH 007-04	172	HWH 228-00	185	HWH 540-01	169
HWC 017-05	12	HWH 015-00	172	HWH 237-00	185	HWH 541-02	169
HWC 019-12	12	HWH 016-01	172	HWH 239-00	185	HWH 542-03	169
HWC 030-54	13	HWH 017-02	172	HWH 252-01	184	HWH 543-04	169
HWC 031-54	13	HWH 024-00	172	HWH 253-02	184	HWH 544-05	169
HWC 050-12	98	HWH 025-18	172	HWH 259-00	124	HWH 545-00	173
HWC 051-13	98	HWH 027-17	173	HWH 260-03	124	HWH 551-02	171
HWC 052-14	98	HWH 028-00	173	HWH 261-05	124 + 128	HWH 552-03	171
HWC 053-16	98	HWH 029-00	173	HWH 262-08	124	HWH 554-05	171
HWC 070-10	98	HWH 030-00	173	HWH 263-10	124	HWH 555-06	171
HWC 071-10	98	HWH 031-00	173	HWH 264-13	124	HWH 556-07	171
HWC 072-11	98	HWH 032-00	173	HWH 271-00	125		
HWC 073-11	98	HWH 033-06	173	HWH 272-02	125	<b>HWJ</b>	
HWC 074-13	98	HWH 040-00	174	HWH 272-03	125 + 128	HWJ 001-05	3
HWC 075-13	98	HWH 041-01	174	HWH 272-04	125	HWJ 002-06	3
HWC 082-14	98	HWH 042-02	174	HWH 272-05	125	HWJ 003-09	3
HWC 083-16	98	HWH 043-00	174	HWH 300-01	126	HWJ 004-08	3
HWC 090-10	98	HWH 047-00	174	HWH 301-11	126	HWJ 006-23	3
HWC 091-10	98						



Katalog-Nr. Cat. No.	Abb. auf Seite Illustr. on page	Katalog-Nr. Cat. No.	Abb. auf Seite Illustr. on page	Katalog-Nr. Cat. No.	Abb. auf Seite Illustr. on page	Katalog-Nr. Cat. No.	Abb. auf Seite Illustr. on page
HWJ 007-43	3	HWL 234-03	201	HWL 379-18	205	SGCI 100-09	248
HWJ 008-17	3	HWL 236-01	201	HWL 380-08	209	SGCI 101-09	248
HWJ 009-18	3	HWL 237-02	201	HWL 381-15	208	SGCI 102-13	248
HWJ 011-16	3	HWL 238-03	201	HWL 382-16	208	SGCI 103-15	248
HWJ 012-09	3	HWL 300-00	203	HWL 383-17	208	SGCI 104-20	248
HWJ 015-09	4	HWL 300-08	207	HWL 384-18	208	SGCI 105-23	248
HWJ 020-05	4	HWL 301-01	202	HWL 386-15	209	SGCI 106-15	248
HWJ 024-00	4	HWL 302-02	202	HWL 387-16	209	SGCI 107-20	248
HWJ 030-00	4	HWL 303-03	202	HWL 388-17	209	SGCI 108-00	250
HWJ 031-00	4 + 121	HWL 304-04	202	HWL 389-18	209	SGCI 109-00	248
HWJ 032-16	121 + 128	HWL 305-05	202	HWL 390-00	256	SGCI 110-12	249
HWJ 033-00	123	HWL 306-01	206			SGCI 111-14	249
HWJ 090-00	5	HWL 307-02	206	<b>HWM</b>		SGCI 112-31	249
HWJ 091-00	5	HWL 308-03	206	HWM 020-00	226	SGCI 113-15	249
HWJ 091-00	128	HWL 309-04	206	HWM 021-00	226	SGCI 114-18	249
HWJ 093-00	5	HWL 311-01	203	HWM 022-01	226	SGCI 115-00	249
		HWL 312-02	203	HWM 023-02	226	SGCI 116-06	250
<b>HWK</b>		HWL 313-03	203	HWM 024-00	226	SGCI 117-10	250
HWK 003-18	65	HWL 314-04	203	HWM 025-00	226	SGCI 118-18	250
HWK 005-24	64	HWL 315-05	203	HWM 029-00	127	SGCI 119-13	250
HWK 011-16	65	HWL 316-01	207	HWM 031-00	97	SGCI 130-09	251
HWK 012-00	106	HWL 317-02	207	HWM 032-00	97	SGCI 131-13	251
HWK 013-00	106	HWL 318-03	207	HWM 032-01	97 + 127	SGCI 132-14	251
HWK 023-00	106	HWL 319-04	207	HWM 039-01	123	SGCI 133-13	251
HWK 030-04	67	HWL 321-30	214	HWM 040-84	193	SGCI 134-13	251
HWK 031-05	67	HWL 322-31	214	HWM 041-84	193	SGCI 135-15	251
HWK 035-04	67	HWL 323-33	214	HWM 042-84	193	SGCI 136-18	251
HWK 040-01	67	HWL 324-32	214	HWM 043-30	194	SGCI 137-31	251
HWK 041-02	67	HWL 325-99	214	HWM 044-30	194	SGCI 138-15	252
HWK 042-03	67	HWL 330-30	214	HWM 045-08	194	SGCI 139-18	252
HWK 045-01	67	HWL 331-31	214	HWM 050-17	194	SGCI 140-23	252
		HWL 332-33	214	HWM 064-00	97	SGCI 141-15	252
<b>HWL</b>		HWL 333-32	214	HWM 083-00	97	SGCI 142-20	252
HWL 200-00	200	HWL 334-99	214	HWM 084-00	97	SGCI 143-15	252
HWL 201-00	200	HWL 341-01	210	HWM 087-10	97 + 140	SGCI 144-26	252
HWL 202-01	200	HWL 342-02	210	HWM 088-25	97 + 140	SGCI 330-07	253
HWL 203-02	200	HWL 343-03	210	HWM 100-05	228	SGCI 338-00	253
HWL 204-03	200	HWL 344-04	210	HWM 101-10	228	SGCI 340-05	253
HWL 205-04	200	HWL 345-05	211	HWM 105-09	228		
HWL 206-01	200	HWL 346-06	211	HWM 106-22	229		
HWL 207-02	200	HWL 347-07	211	HWM 107-05	128 + 228		
HWL 208-03	200	HWL 348-08	211	HWM 115-05	227		
HWL 214-01	200	HWL 351-01	212	HWM 116-10	227		
HWL 215-02	200	HWL 352-02	212	HWM 117-12	227		
HWL 216-03	200	HWL 353-03	212				
HWL 218-00	201	HWL 354-04	212	<b>HWN</b>			
HWL 219-01	201	HWL 355-05	213	HWN 250-18	198		
HWL 220-02	201	HWL 356-06	213	HWN 251-20	198		
HWL 221-03	201	HWL 357-07	213	HWN 252-22	198		
HWL 222-04	201	HWL 358-08	213	HWN 270-21	198		
HWL 224-01	201	HWL 370-08	205	HWN 272-22	198		
HWL 225-02	201	HWL 371-15	204	HWN 273-21	198		
HWL 226-03	201	HWL 372-16	204	HWP 007-01	184		
HWL 228-01	201	HWL 373-17	204				
HWL 229-02	201	HWL 374-18	204	<b>SGCI</b>			
HWL 230-03	201	HWL 376-15	205	SGCI 050-00	247		
HWL 232-01	201	HWL 377-16	205	SGCI 051-20	247		
HWL 233-02	201	HWL 378-17	205	SGCI 052-15	247		



Abdrucklöffel	200 - 214	<b>Crown butler</b> Kronenabnehmer	197
Abhalter, Gingiva-	105	<b>Crown Rocket</b> Kronenabnehmer	197
Abhalter, Gingiva-/Mukosa-	106	<b>Cryer</b> Wurzelheber	36
Abhalter, Lippen-	62, 133	<b>Cumine</b> Zahnreiniger	108
Abhalter, Wangen- und Lippen-	61 - 63, 136	Dappengläser	193
Abnehmer, Provisorien-	109	<b>Dean</b> Chirurgische Schere	50
Abnehmer, Skalpellklingen	56	Diagnostik Set	13 + 14
<b>Abott</b> Zahnreiniger	108	Digital-Taschen-Meßschieber	219
Abziehsteine	106	<b>Dr. Göbel / Dr. Gruner</b> Präparationstiefenmesssonde	105
Achatspatel	186	<b>Dr. Schemmel</b> Luxationsinstrument	44
<b>Aderer</b> Draht- und Klammerbiegezeuge	224	Draht- und Klammerbiegezeugen	224
<b>Adson</b> Pinzette	101	Dycal-Instrumente	179
<b>Adson-Brown</b> Pinzette	101	Elevatorien	65, 137
<b>Allen</b> Raspatorium	64	Endo Box	123
Amalgaminstrumente	181 - 183	Endo Ring	123
Amalgampistolen	181	Endodontie Basis Set	235 + 236
Amalgamschnitzinstrumente	183	Endodontie Set	128
Amalgamträger	181	Endodontiesonden	4, 121
Anatomische Pinzetten	98 - 100	Endo-Exkavator	121
<b>Apical</b> Wurzelheber	36	Exkavator, Endo-	121
<b>Arkansas</b> Abziehsteine	106	Exkavatoren	157 - 160
Arterienklemmen	58 + 59	Extraktionsset	22 - 24
Artikulationspapierpinzetten	184	Faden/Retraktions-Stopfer	184
<b>Ash</b> Instrument für plastische Füllungen	173	<b>Fahnenstock</b> Wachsmesser	217
<b>Ash</b> Zahnsonde	2	<b>Farabeuf</b> Wundhaken	60
Atraumatische Pinzetten	100	Farbringe	117
Aufwachsinstrumente	215	Feilen, Furkations-	110
<b>Baby Metzenbaum</b> Chirurgische Schere	53	Feilen, Knochen-	66
<b>Baby-Crile-Wood</b> Nadelhalter	73	Feilen, Parodontal-	110
Back Action Meißel	109	Flachzangen	224
<b>Backhaus</b> Tuchklemme	60	<b>Flohr</b> Wurzelheber	34
<b>Barnhart</b> Kürette	107	Fotospiegel	10 + 11
<b>Barnhart</b> Zahnreiniger	112	<b>Frahm</b> Amalgaminstrument	182
<b>Barraquer</b> Mikro-Nadelhalter	75, 96, 139	<b>Freer</b> Elevatorium	65
<b>Beale</b> Modellierinstrument	216	<b>Freer-Yasargil</b> Raspatorium	64
Behälter, Pellet-	97	<b>Friedmann</b> Hohlmeißelzange	69
<b>Bein</b> Wurzelheber	34 + 37	Füllinstrumente	127, 172 - 181
<b>Bernard</b> Wurzelheber	38	Füllspatel, Mikro-	126
<b>Beyer</b> Hohlmeißelzange	69	Furkationsfeilen	110
Biegezeugen, Draht- und Klammer-	224	Gefäßklemmen	58 + 59
<b>Black</b> Instrument für plastische Füllungen	180 + 181	<b>Gerald</b> Pinzette	102
<b>Black</b> Provisorienabnehmer	109	Gewebescheren, Mikro-	133
<b>Black</b> Schneidendes Instrument	161	<b>Gillies</b> Pinzette	102
<b>Blumenthal</b> Hohlmeißelzange	69	Gingiva-/Mukosa-Abhalter	106
<b>Böhm</b> Teleskopkronenzange	220	Gingiva-Abhalter	105
Bohrerständer	127 + 194	Gingivalrandschräger	161
<b>Boley</b> Schieblehre	218	Gingivektomiemesser	58
<b>Buser</b> Raspatorium	66 + 134	Gingivektomiescheren	54
<b>Castroviejo</b> Mikro-Nadelhalter	74 + 75	Gipsmesser	217
Cavitheber	161	Glasplatten	187
<b>Cawood-Minnesota</b> Wangen- und Lippenabhalter	61	<b>GLICK 1</b> Wurzelkanalstopfer	121
Chirurgie Basis Set	233 + 234	<b>GLICK 2</b> Endo-Exkavator	121
Chirurgische Nadeln	76	<b>Goldman Fox</b> Raspatorium	66
Chirurgische Pinzetten	98 + 100	<b>Goldman-Fox</b> Chirurgische Schere	50
Chirurgische Scheren	49 - 55	<b>Goldman-Fox</b> Gingivektomieschere	54
Chirurgisches Implant und Sinus Lift Set	242 - 244	<b>Gracey</b> -Küretten	114 - 116, 118 - 120
<b>Clev-Dent</b> Raspatorium	65	Granulatstopfer	137
<b>Cleveland</b> Hohlmeißelzange	69	Greifpinzetten	127
<b>College</b> Zahnpinzette	13	Griffe für Mikro-Klingen	131
<b>Columbia</b> Zahnreiniger	111 + 112	Griffe für Skalpelle	56 + 57
Condenser	126	Griffe für Mundspiegel	5 - 7, 13, 140
<b>Coupland</b> Hohlmeißel	68	<b>Gritman</b> Gipsmesser	217
<b>Coupland</b> Wurzelheber	42	<b>Gutowski</b> Provisorienzange	196
<b>Crile</b> Gefäßklemme	59	<b>Halsey</b> Nadelhalter	70 + 72
<b>Crile</b> Nadelhalter	70	<b>Halstead-Mosquito</b> Schlauchklemme	58
<b>Crile-Murrey</b> Nadelhalter	70	Halter, Mikro-Nadel-	74 + 75, 96
<b>Crile-Wood</b> Nadelhalter	71 + 73	Halter, Nadel-	70 - 75, 96



Halter, Pinsel-	184	Klemmen, Gefäß-	58 + 59
Halter, Servietten-	5	Klemmen, Schlauch-	58 + 59
Halter, Wangen-	47 + 48	Klemmen, Tuch-	60
<b>Hammacher</b> Hartgipsschneidezange	225	Klingen, Mikro-	131
<b>Hammacher</b> Taschenmesssonde	104	Klingen, Skalpell-	56 + 57
<b>Hammacher</b> Teleskopaktivierungszange	222	Klingenabnehmer, Skalpell-	56
<b>Hammacher</b> Teleskopkronenzange	220	Knochenerweiterungsinstrumente	154 + 155
Hammer	68 + 134	Knochenfeilen	66
Handwaschbürsten	229	Knochenmühle (manuell)	138
Hartgipsschneidezangen	225	Knochenmacher	141
Hebelseitenschneider	224	Knochenmehlschalen	141
Heber, Cavit-	161	Knochenmehlspritzen	132
Heber, Papillen-	134	Knochenverdichter	141
Heber, Wurzel-	34 - 44	Kofferdam-Instrumente	189 - 192
<b>Hegar-Baumgartner</b> Nadelhalter	72	Kofferdam-Klammer	192
<b>Heidbrink</b> Wurzelheber	41 + 42	Kofferdam-Rahmen	192
<b>Heidemann</b> Instrument für plastische Füllungen	172 + 174 + 176 + 180	Kofferdam-Set	129 + 130, 190 + 191
<b>Helios</b> Molarstopfer	180	Kofferdam-Zangen	189 + 191
<b>Hemingway</b> Scharfe Löffel	67	Kollagen - <b>Parasorb Cone</b>	78
<b>Hermkens</b> Pinselhalter	184	Kollagen - <b>Parasorb Cone Genta</b>	78
<b>Hilger</b> Wangenhalter	47	Kollagen - <b>Parasorb Fleece</b>	77
<b>Hirschfeld</b> Feile zur Wurzelglättung	110	Kollagen - <b>Parasorb Fleece HD</b>	77
<b>Hoffmann</b> Mikrofüllspatel	126	Kollagen - <b>Parasorb Resodont</b>	79
<b>Hoffmann</b> Mikrosonde	126	Kollagen - <b>Parasorb Resodont Forte</b>	79
<b>Hoffmann</b> Mikrostopfer	126	Komposite Instrumente	162 - 171
<b>Hoffmann</b> Sinusbodenaugmentationssatz	135 + 136	<b>Kramer Nevins</b> Raspatorium	66
Hohlmeißel	68	Kronenabnehmer	196 + 197
Hohlmeißelzangen	69	Kronenaufbieger	195
<b>Hollenback</b> Amalgaminstrument	182	Kronenhaltepinzetten	223
<b>Hollenback</b> Instrument für plastische Füllungen	180	Kroneninstrumente	195 + 196
<b>Howard</b> Raspatorium	64	Kronenspreizzangen	195
<b>Hyllin</b> Modellierinstrument	216	Küretten	107, 111, 114 - 116
Instrumente, Amalgam-	181 - 183	Küretten, <b>Gracey</b>	114 - 116, 118 - 120
Instrumente, Aufwachs-	215	Küretten, Sinus Lift	142 - 145
Instrumente, Füll-	127, 172 - 181	Küretten, Sinus Membran	140
Instrumente, Keramik-	223	Küretten, Universal-	111
Instrumente, Knochenerweiterungs-	154 + 155	<b>La Grange</b> Chirurgische Schere	50 + 54
Instrumente, Kofferdam-	189 - 192	<b>Lange</b> Cavitheber	161
Instrumente, Komposite	162 - 171	<b>Lange</b> Zahnsonden	2
Instrumente, Kronen-	195 + 196	<b>Langer</b> Kürette	107
Instrumente, Luxations-	39 + 40 + 44	<b>LeCron</b> Modellierinstrument	216
Instrumente, Modellier-	216	Ligatur- und Nahtscheren	96
Instrumente, Platzier-	134 + 180	<b>Lindenblatt</b> Wurzelheber	35
Instrumente, Polier-	127	<b>Lindo-Levin</b> Wurzelheber	38
Instrumente, Schneidende	161	Lineal, Mess-	127
Instrumente, Splitter-	122	Lippenabhalter	62, 133
Instrumente, Tunnelier-	105	<b>Liston</b> Hohlmeißelzange	69
<b>Interlook</b> Messzirkel	218	<b>Locklin</b> Chirurgische Schere	50
<b>Ivory</b> Amalgamträger	181	Löffel, Abdruck-	200 - 214
<b>Iwanson</b> Messzirkel	218	Löffel, Scharfe	67
<b>Jörgensen</b> Planator	178	<b>London-College</b> Zahnpinzette	12
<b>Joseph</b> Chirurgische Schere	49 + 55	<b>Lucas</b> Raspatorium	65
Kassetten, Norm-Tray-	226	<b>Luer</b> Hohlmeißelzange	69
Kassetten, Sterilisations-	11, 227 - 229	Luxationsinstrumente	39 + 40 + 44
Keile, Mund-	60	Marginal-Messer	195
<b>Kelly</b> Chirurgische Schere	49 + 50	<b>Martini</b> Scharfer Löffel	67
<b>Kelly</b> Gefäßklemme	59	<b>Mathieu</b> Nadelhalter	70
<b>Kelly</b> Naht- und Zahnfleischschere	55	<b>Mathieu-Kocher</b> Nadelhalter	70 - 72, 96
Keramik-Instrumente	223	Matrizen	187 + 188
<b>Kilner</b> Nadelhalter	72	Matrizenspanner	187 + 188
Kinderzahnzangen	26 - 29	<b>Mayo-Hegar</b> Nadelhalter	71 + 73
<b>Kirkland</b> Gingivektomiemesser	58	<b>Mayo-Hegar-Grazil</b> Nadelhalter	71
Klammer- und Drahtbiegezangen	224	<b>McCall</b> Zahnreiniger	111
Klammern, Kofferdam-	192	<b>McKesson</b> Mundkeil	60
<b>Klein</b> Kinderzahnzangen	28	Medikamentenschalen	97 + 127
Klemmen, Arterien-	58 + 59	Meißel	156
		Meißel, Back Action	109



Meißel, Hohl-	68	Öl, Schleif-	106
<b>Meriam</b> Zahnpinzette	12 + 13	<b>Olsen-Hegar</b> Nadelhalter	72
Messer, Gingivektomie-	58	Ölstift	229
Messer, Gips-	217	OP-Spezial-Scheren	54 + 55
Messer, Marginal-	195	Osteotome	146 - 153
Messer, Schmelz-	161	<b>P.K. Thomas</b> Aufwachsinstrumente	215
Messer, Wachs-	217	Papillenheber	134
Messer, Zahnfleisch-	103	Parallelometer-Spiegel	140
Messlineal	127	Parodontalfeilen	110
Messsonden, Präparationstiefen-	105	Parodontose Untersuchungsset	231
Messsonden, Taschen-	104 + 105	<b>Pean</b> Schlauchklemme	59
<b>Metzenbaum fino</b> Chirurgische Schere	53	<b>Peet</b> Splitterzange	122
<b>Michigan</b> Taschenmesssonde	105	Pellet-Behälter	97
<b>Micro-Adson</b> Pinzette	101	Periotome	44, 138
<b>Micro-Halstead</b> Mikroklemme	58	Pinself	184 + 216
<b>Micro-Hartmann</b> Mikroklemme	58	Pinselfhalter	184
Mikrochirurgisches Basis Set	245 + 246	Pinzetten	12 - 14, 98 - 102, 134, 143
Mikro-Füllspatel	126	Pinzetten, Anatomisch	98 - 100
Mikro-Gewebeschere	133	Pinzetten, Artikulationspapier-	184
Mikro-Klingen	131	Pinzetten, Atraumatisch	100
Mikro-Nadelhalter	74 + 75, 96	Pinzetten, Chirurgisch	98 + 100
Mikro-Pinzetten	139	Pinzetten, Greif-	127
Mikro-Raspatorien	106	Pinzetten, Kronenhalte-	223
Mikro-Scheren	140	Pinzetten, Mikro-	139
Mikro-Sonden	126	Pinzetten, Naht-	96
Mikro-Spiegel	127	Pinzetten, Titan-	131
Mikro-Stopfer	126	Pinzetten, Zahn-	12 - 14
<b>Miller</b> Artikulationspapierpinzetten	184	Planatoren	178
<b>Miller-Apexo</b> Wurzelheber	37	Platzierinstrumente	134 + 180
<b>Miller-Colburn</b> Knochenfeile	66	Polierinstrumente	126
<b>Miller-Colburn</b> Raspatorium	66	Präparationstiefenmesssonden	105
<b>Mini-Friedman</b> Hohlmeißelzange	69	<b>Prichard</b> Raspatorium	64
<b>Mini-LeCron</b> Modellierinstrument	216	<b>Prof. Dr. Günay</b> Gingiva-/Mukosa-Abhalter	106
<b>Minnesota</b> Wangen- und Lippenabhalter	133	<b>Prof. Dr. Günay</b> Gingiva-Abhalter	105
Misch- und Laborspatel	198	<b>Prof. Dr. Günay</b> Mikro-Raspatorium	106
<b>Mltchel</b> Zahnreiniger	108	<b>Prof. Dr. Günay</b> Wangenhalter	48
Modellierinstrumente	216	<b>Profi-Design</b> Komposite Instrument	171
Molarstopfer	180	Provisorienabnehmer	109
<b>Molt</b> Mundsperrerr	63	Provisorienzangen	196
<b>Molt</b> Raspatorium	64 + 65	Rahmen, Kofferdam-	192
<b>Morell</b> Kronenabnehmer	196	<b>Ralk</b> Splitterzange	122
<b>Mortonson</b> Instrument für plastische Füllungen	177	Raspatorien	64 - 66, 137
<b>Mosquito</b> Gefäßklemme	59	Raspatorien, Mikro-	106
Mundkeile	60	Reiniger, Zahn-	107, 109, 111 - 113
Mundsperrerr	63	Restaurationsset	237 - 239
Mundspiegel	8 + 9	Retraktions-/Faden-Stopfer	184
Mundspiegelgriffe	5 - 7, 13, 140	<b>Rhodes</b> Back Action Meißel	109
<b>Nabers</b> Taschenmesssonde	104	<b>Routurier</b> Zahnzangen	18
Nadel, Chirurgisch	76	<b>Roux</b> Wundhaken	61
Nadelhalter	70 - 75, 96	<b>Ruskin-Gratzil</b> Hohlmeißelzange	69
Nadelhalter, Mikro-	74 + 75, 96	<b>Ryder-Gratzil</b> Nadelhalter	73
Naht- und Ligaturscheren	96	Sägeblätter	225
Nahtmaterial - <b>Glycolon</b>	82 + 83	Sägen	225
Nahtmaterial - <b>Mopylen</b>	93	<b>Scalette</b> Zahnreiniger	112 + 113
Nahtmaterial - <b>PGA-Resorba</b>	84 + 85	Schalen	97 + 140
Nahtmaterial - <b>Polyester</b>	91	Schalen, Knochen-	141
Nahtmaterial - <b>Resolon</b>	88 + 89	Schalen, Medikamenten-	97 + 127
Nahtmaterial - <b>Resotex Oral</b>	94	Schalen, Nieren-	97
Nahtmaterial - <b>Seide</b>	86 + 87	Scharfe Löffel	67
Nahtmaterial - <b>Supolene</b>	92	Scheren	49 - 55, 136, 143
Nahtmaterial - <b>Supramid</b>	90	Scheren mit Hartmetalleinlagen	53
Nahtmaterial - <b>Supramid Oral</b>	94	Scheren, Chirurgisch	49 - 55
Nahtpinzetten	96	Scheren, Gingivektomie-	54
Nervkanalstopfer	124	Scheren, Mikro-	140
Nezangen	123	Scheren, Mikro-Gewebe-	133
Nierenschalen	97	Scheren, Naht- und Ligatur-	96
Norm-Tray-Kassetten	226	Scheren, OP-Spezial-	54 + 55



Scheren, Zahnfleisch-	54 + 55	<b>Taylor</b> Pinzette	102
Schieblehren	218 + 219	<b>Teleflex</b> Teleskopkronenzange	221 + 222
Schlauchklemmen	58 + 59	Teleskopaktivierungszangen	222
Schleiföl	106	Teleskopkronenzangen	220 - 222
<b>Schluger</b> Parodontalfeilen	110	Tiefenmesssonden, Präparations-	105
Schmelzmesser	161	Titan-Pinzetten	131
Schneidende Instrumente	161	<b>Toennis</b> Nadelhalter	72
Seitenschneider, Hebel-	224	<b>Towner</b> Zahnreiniger	108
<b>Seldin</b> Raspatorium	65	Tuchklemmen	60
<b>Semken</b> Pinzette	101	Tunnelierinstrumente	105
Separierspatel	185	Universalküretten	111
Serviettenhalter	5	Universalzangen	224
Set für Kronen und Brücken	240 + 241	Untersuchungsset	230
Set zur chirurgischen Nahtentfernung	232	Untersuchungsset, Parodontose	231
Set, Chirurgie Basis	233 + 234	Vestibulum	62, 133
Set, Diagnostik	13 + 14	<b>W.F. Barry</b> Wurzelheber	43
Set, Endodontie	128	Wachsmesser	217
Set, Endodontie Basis	235 + 236	Wachspinsel	216
Set, Extraktion	22 - 24	<b>Wagner</b> Chirurgische Schere	51
Set, Kofferdam	129 + 130, 190 + 191	<b>Waldsachs</b> Universalzange	224
Set, Mikrochirurgie Basis	245 + 246	Wangen- und Lippenabhalter	61 - 63, 136
Set, Parodontose Untersuchungs-	231	Wangenhalter	47 + 48
Set, Restaurations-	237 - 239	<b>Ward</b> Amalgaminstrument	182
Set, Untersuchungs-	230	<b>Warwick-James</b> Wurzelheber	42
Sinus Lift Küretten	142 - 145	<b>Westcott</b> Amalgaminstrument	183
Sinus Membran Küretten	140	<b>White</b> Amalgaminstrument	183
Sinusbodenaugmentationssatz	135 + 136	<b>White</b> Instrument für plastische Füllungen	172 + 179
Skalpelle	56 + 57, 103	<b>White</b> Zahnsonde	2
Skalpellgriffe	56 + 57	<b>WHO</b> Taschenmesssonde	104 + 105
Skalpellklingen	56 + 57	<b>Wieder</b> Wangenhalter	47
Skalpellklingenabnehmer	56	<b>Williams</b> Taschenmesssonde	104
Solingen Classics	247 - 256	<b>Williger</b> Raspatorium	65
Sonden, Endodontie-	4, 121	<b>Winter</b> Wurzelheber	43
Sonden, Mikro-	126	<b>Wiro-FILL</b> Komposite Instrument	162 - 170
Sonden, Präparationstiefenmess-	105	Wundhaken	60 + 61
Sonden, Taschenmess-	104 + 105	Wurzelheber	34 - 44
Sonden, Zahn-	1 - 4, 13	Wurzelkanalstopfer	121 + 124
Sonden, Zahn- aus WIRONIT	3 + 4	<b>ZA M. Beck</b> Wurzelheber	43
Sondeneinsätze	5	<b>Zahle</b> Modellierinstrument	216
Spatel, Achat-	186	Zahnfleischmesser	103
Spatel, Misch- und Labor-	198	Zahnfleischscheren	54 + 55
Spatel, Separier-	185	Zahnpinzetten	12 - 14
Spatel, Zement-	185 + 186	Zahnreiniger	107, 109, 111 - 113
<b>Spencer</b> Naht- und Ligaturschere	96	Zahnsonden	1 - 4, 13
Sperrer, Mund-	63	Zahnsonden aus WIRONIT	3 + 4
Spiegel, Foto-	10 + 11	Zahnzangen	15 - 33
Spiegel, Mikro-	127	Zahnzangen für Kinder	26 - 29
Spiegel, Mund-	8 + 9	Zangen, Draht- und Klammerbiege-	224
Spiegel, Parallelometer-	140	Zangen, Flach-	224
Spitzenschutz	229	Zangen, Hartgipsschneide-	225
Splitterinstrumente	122	Zangen, Hohlmeißel-	69
Splitterzangen	122	Zangen, Kofferdam-	189 + 191
Spreizer	125	Zangen, Kronenspreiz-	195
Spritzen, Knochen-	132	Zangen, Nerv-	123
Spritzen, Zylinderampullen-	45 + 46	Zangen, Provisorien-	196
Ständer, Bohrer-	127 + 194	Zangen, Splitter-	122
Sterilisationskassetten	11, 227 - 229	Zangen, Teleskopaktivierungs-	222
<b>Sternberg</b> Wangen- und Lippenabhalter	62	Zangen, Teleskopkronen-	220 - 222
<b>Stieglitz</b> Splitterzange	122	Zangen, Universal-	224
Stopfer, Granulat-	137	Zangen, Zahn-	15 - 33
Stopfer, Mikro-	126	Zangen, Zahn- für Kinder	26 - 29
Stopfer, Molar-	180	Zementspatel	185 + 186
Stopfer, Nervkanal-	124	Zylinderampullenspritzen	45 + 46
Stopfer, Retraktions-/Faden-	184		
Stopfer, Wurzelkanal-	121 + 124		
<b>Sugarman</b> Parodontalfeile	110		
Taschenmesssonden	104 + 105		



<b>Abott</b> Scaler	108	Chisels, Enamel	161
<b>Aderer</b> Wire and clasp bending pliers	224	Clamp forceps	58 + 59
<b>Adson</b> Forceps	101	Clamps, Rubber dam	192
<b>Adson-Brown</b> Forceps	101	Clamps, Towel	60
Agate spatulas	186	Clamps, Tubing	58 + 59
<b>Allen</b> Raspatory	64	<b>Clev-Dent</b> Raspatories	65
Amalgam carriers	181	<b>Cleveland</b> Rongeur	69
Amalgam guns	181	Collagen - <b>Parasorb Cone</b>	78
Amalgam instruments	182 + 183	Collagen - <b>Parasorb Cone Genta</b>	78
Amalgam trimmers	183	Collagen - <b>Parasorb Fleece</b>	77
<b>Apical</b> Root elevators	36	Collagen - <b>Parasorb Fleece HD</b>	77
<b>Arkansas</b> Sharpening stones	106	Collagen - <b>Parasorb Resodont</b>	79
Artery forceps	58 + 59	Collagen - <b>Parasorb Resodont Forte</b>	79
Articulating paper forceps	184	<b>College</b> Tweezers	13
<b>Ash</b> Probes and explorers	2	Colour rings	117
Atraumatic forceps	100	<b>Columbia</b> Scalars	111 + 113
<b>Baby Metzenbaum</b> Operating scissors	53	Composite instruments	162 - 171
<b>Baby-Crile-Wood</b> Needle holders	73	Condensers	126
Back Action chisels	109	Condensers, Nerve canal	124
<b>Backhaus</b> Towel clamps	60	Condensers, Root canal	124
<b>Barnhart</b> Curettes	107	Containers, Pellet	97
<b>Barnhart</b> Scalars	113	<b>Coupland</b> Gouges	68
<b>Barraquer</b> Micro needle holders	75, 96 + 139	<b>Coupland</b> Root elevators	42
<b>Beale</b> Modelling instruments	215 + 216	<b>Crile</b> Clamp forceps	59
<b>Bein</b> Root elevators	34 + 37	<b>Crile</b> Needle holders	70
Bending pliers, Wire and clasp	224	<b>Crile-Murray</b> Needle holders	70
<b>Bernard</b> Root elevators	38	<b>Crile-Wood</b> Needle holders	71 + 73
<b>Beyer</b> Rongeur	69	Crown and bridge set	240 + 241
<b>Black</b> Cutting instruments	161	<b>Crown butler</b> Crown removers	197
<b>Black</b> Plastic filling instruments	180 + 181	Crown holding forceps	223
Blades, Micro	131	Crown instruments	195 - 197
Blades, Saw	225	Crown removers	196 + 197
Blades, Scalpels	56 + 57	<b>Crown Rocket</b> Crown removers	197
<b>Blumenthal</b> Rongeur	69	Crown spreaders	195
<b>Böhm</b> Telescope crown pliers	220	Crown spreading pliers	195
<b>Boley</b> Sliding calipers	218	<b>Cryer</b> Root elevators	36
Bone bowls	141	<b>Cumine</b> Scalars	108
Bone curettes	67	Cups, Medicament	97 + 127
Bone files	66	Curettes	107, 111, 114 - 116, 118 - 120
Bone mill (manual)	138	Curettes, Bone	67
Bone packers	141	Curettes, <b>Gracey</b>	114 - 116, 118 - 120
Bone scrapers	141	Curettes, Sinus lift	142 - 145
Bone spreading instruments	154 + 155	Curettes, Sinus Membrane	137
Bone syringes	132	Cutting instruments	161
Bowls, Bone	141	Dappen glasses	193
Bowls, Kidney	97	<b>Dean</b> Operating scissors	50
Brush holders	184	Depths measuring probes, Preparation-	105
Brushes	184 + 216	Diagnostic set	13 + 14
Bur stands	127 + 194	Digital pocket calipers	219
Burnishers	126	Dishes	97 + 140
<b>Buser</b> Raspatory	66 + 134	Double action side nippers	224
Calibrated probes	104 + 105	<b>Dr. Göbel / Dr. Gruner</b> Preparation depths measuring probes	105
Calipers	218 + 219	<b>Dr. Schemmel</b> Luxation instruments	44
Cartridge syringes	45 + 46	Dressing forceps	98 - 100
Carvers, Interproximal	183	Dressing forceps, Micro	102
Cassettes, Norm-Tray	226	Dycal instruments	179
Cassettes, Sterilisation	11, 227 - 229	Elevators, Papilla	134
<b>Castroviejo</b> Micro needle holders	74 + 75	Elevators, Periosteal	65
Cavit lifters	161	Elevators, Root	34 - 44
<b>Cawood-Minnesota</b> Cheek and lip retractors	61	Enamel chisels	161
Cement spatulas	185 + 186	Endo boxes	123
Ceramic instruments	223	Endo excavators	121
Cheek and lip retractors	61 - 63, 133	Endo rings	123
Cheek retractors	47 + 48	Endodontic basis set	235 + 236
Chisels	156	Endodontic explorers	4, 121
Chisels, Back Action	109		



Endodontic set	128	<b>Hammacher</b> Telescope crown pliers	220
Examination set	230	Handles, Micro blades	131
Examination set, Periodontitis	231	Handles, Mouth mirrors	5 - 7, 13
Excavators	157 - 159	Handles, Scalpels	56 + 57
Excavators, Endo	121	Hard plaster nippers	225
Explorers	1 - 4, 13	<b>Hegar-Baumgartner</b> Needle holders	72
Explorers from WIRONIT	3 + 4	<b>Heidbrink</b> Root elevators	41 + 42
Explorers, Endodontic	4, 121	<b>Heidemann</b> Plastic filling instruments	172 + 174 + 176 + 180
Extracting forceps	15 - 33	<b>Hemingway</b> Bone curettes	67
Extracting forceps for children	26 - 29	<b>Hilger</b> Cheek retractors	47
Extraction set	22 - 24	<b>Hirschfeld</b> Files for roots	110
<b>Fahnenstock</b> Wax knife	217	<b>Hoffmann</b> Micro filling spatulas	126
<b>Farabeuf</b> Retractors	60	<b>Hoffmann</b> Micro pluggers	126
Files, Bone	66	<b>Hoffmann</b> Micro probes	126
Files, Furcation	110	<b>Hoffmann</b> Sinus base augmentation set	135 + 136
Files, Periodontal	110	Holders, Brush	184
Filling instruments	127	Holders, Micro needle	74 + 75
Flat nose pliers	223	Holders, Napkin	5
<b>Flohr</b> Root elevators	34	Holders, Needle	70 - 75
Forceps	98 - 102	<b>Hollenback</b> Amalgam instruments	182
Forceps, Artery	58 + 59	<b>Hollenback</b> Plastic filling instruments	180
Forceps, Articulating paper	184	<b>Howard</b> Raspatories	64
Forceps, Atraumatic	100	<b>Hylin</b> Modelling instruments	216
Forceps, Clamp	58 + 59	Impression trays	200 - 214
Forceps, Crown holding	223	Instruments, Amalgam	182 + 183
Forceps, Dressing	98 - 100	Instruments, Bone spreading	154 + 155
Forceps, Extracting	15 - 33	Instruments, Ceramic	223
Forceps, Extracting, for children	26 - 29	Instruments, Composite	162 - 171
Forceps, Grasping	127	Instruments, Crown	195 - 197
Forceps, Micro dressing	102	Instruments, Cutting	161
Forceps, Rubber dam	189 + 191	Instruments, Filling	127
Forceps, Splinter	122	Instruments, Luxation	39 + 40 + 44
Forceps, Suture	96	Instruments, Modelling	216
Forceps, Tissue	100 + 102	Instruments, Placement	134 + 180
Forceps, Titanium	131	Instruments, Plastic filling	172 - 181
<b>Frahm</b> Amalgam instruments	182	Instruments, Rubber dam	189 - 192
<b>Freer</b> Periosteal elevators	65	Instruments, Splinter	122
<b>Freer-Yasargil</b> Raspatories	64	Instruments, Tunnelling	105
<b>Friedmann</b> Rongeur	69	Instruments, Waxing	215
Furcation files	110	<b>Interlook</b> Measuring calipers	218
Gags, Mouth	63	Interproximal carvers	183
<b>Gerald</b> Micro dressing forceps	102	<b>Ivory</b> Amalgam carriers	181
<b>Gillies</b> Tissue forceps	102	<b>Iwanson</b> Measuring calipers	218
Gingiva / mucosa retractors	106	Jars	193
Gingiva retractors	105	<b>Jørgensen</b> Plastic filling instruments	178
Gingivectomy knives	58	<b>Joseph</b> Operating scissors	49 + 55
Gingivectomy scissors	54	<b>Kelly</b> Clamp forceps	59
Glass slabs	187	<b>Kelly</b> Operating scissors	49 + 50
<b>GLICK 1</b> Root canal plugger	121	<b>Kelly</b> Suture and gum scissors	55
<b>GLICK 2</b> Endo excavator	121	Kidney bowls	97
<b>Goldman Fox</b> Raspatories	66	<b>Kilner</b> Needle holders	72
<b>Goldman-Fox</b> Gingivectomy scissors	54	<b>Kirkland</b> Gingivectomy knife	58
<b>Goldman-Fox</b> Operating scissors	50	<b>Klein</b> Extracting forceps for children	28
Gouges	68	Knives, Gingivectomy	58
<b>Gracey</b> curettes	114 - 116, 118 - 120	Knives, Gum	103
Granulate pluggers	137	Knives, Marginal	195
Grasping forceps	127	Knives, Plaster	217
<b>Gritman</b> Plaster knife	217	Knives, Wax	217
Gum knives	103	<b>Kramer Nevins</b> Raspatories	66
Gum scissors	54 + 55	<b>La Grange</b> Operating scissors	50 + 54
<b>Gutowski</b> Provisional crown pliers	196	<b>Lange</b> Cavit lifters	161
<b>Halsey</b> Needle holders	70 + 72	<b>Lange</b> Probes and explorers	2
<b>Halstead-Mosquito</b> Tubing clamps	58	<b>Langer</b> Curettes	107
<b>Hammacher</b> Calibrated probes	104	<b>Le Cron</b> Modelling instruments	216
<b>Hammacher</b> Hard plaster nippers	225	Lifters, Cavit	161
<b>Hammacher</b> Telescope activating pliers	222	Lifters, Provisional prothesis	109



<b>Lindenblatt</b> Root elevators	35	Mouth props	60
<b>Lindo-Levin</b> Root elevators	38	<b>Nabers</b> Calibrated probes	104
Lip retractors	62 + 133	Nail brushes (aseptic)	229
<b>Liston</b> Rongeur	69	Napkin holders	5
<b>Locklin</b> Operating scissors	50	Needle holders	70 - 75
<b>London-College</b> Tweezers	12	Needle holders, Micro	74 + 75, 139
<b>Lucas</b> Raspatories	65	Needles, Suture	76
<b>Luer</b> Rongeur	69	Nerve canal condensers	124
Luxation instruments	39 + 40 + 44	Nerve pliers	123
Mallets	68 + 134	Nippers, Hard plaster	225
Margin trimmers	161	Norm-Tray cassettes	226
Marginal knives	195	Oil pens	229
<b>Martini</b> Bone curettes	67	Oil, Sharpening	106
<b>Mathieu</b> Needle holders	70	<b>Olsen-Hegar</b> Needle holders	72
<b>Mathieu-Kocher</b> Needle holders	70 - 72	Operating scissors	49 - 55
<b>Mathieu-Kocher</b> Needle holders	96	Osteotomes	146 - 153
Matrices	187 + 188	<b>P.K. Thomas</b> Waxing instruments	215
Matrix retainers	187 + 188	Packers, Bone	141
<b>Mayo-Hegar</b> Needle holders	71 + 73	Packers, Retraction/threads	184
<b>Mayo-Hegar-Grazil</b> Needle holders	71	Papilla elevators	134
<b>McCall</b> Scalers	111	Parallelometer mirrors	140
<b>McKesson</b> Mouth props	60	<b>Pean</b> Tubing clamps	59
Measuring calipers	218 + 219	<b>Peet</b> Splinter forceps	122
Measuring probes, Preparation depths	105	Pellet containers	97
Measuring rulers	127	Periodontal files	110
Medicament cups	97 + 127	Periodontitis examination set	231
<b>Meriam</b> Tweezers	12 + 13	Periosteal elevators	65
<b>Metzenbaum fino</b> Operating scissors	53	Periotomes	44, 141, 138
<b>Michigan</b> Calibrated probes	105	Photo mirrors	10 + 11
Micro blades	131	Placement instruments	134 + 180
Micro dressing forceps	102	Plaster knives	217
Micro dressing tweezers	139	Plastic filling instruments	172 - 181
Micro filling spatulas	126	Pliers, Crown spreading	195
Micro mirrors	127	Pliers, Flat nose	224
Micro needle holders	74 + 75 + 139	Pliers, Nerve	123
Micro pluggers	126	Pliers, Provisional crown	195
Micro probes	126	Pliers, Telescope activating	222
Micro raspatories	106	Pliers, Telescope crown	220 - 222
Micro scissors	140	Pliers, Universal	224
Micro surgical basis set	245 + 246	Pliers, Wire and clasp bending	224
Micro tissue scissors	133	Pluggers, Granulate	137
<b>Micro-Adson</b> Forceps	101	Pluggers, Micro	126
<b>Micro-Halstead</b> Micro forceps	58	Pluggers, Molar	180
<b>Micro-Hartmann</b> Micro forceps	58	Pluggers, Root canal	121
<b>Miller-Apexo</b> Root elevators	37	Preparation depths measuring probes	105
<b>Miller-Colburn</b> Bone file	66	<b>Prichard</b> Raspatories	64
<b>Miller-Colburn</b> Raspatories	66	Probe tips	5
<b>Mini-Friedman</b> Rongeur	69	Probes	1 - 4, 13
<b>Mini-Le Cron</b> Modelling instruments	216	Probes from WIRONIT	3 + 4
<b>Minnesota</b> Cheek and lip retractors	133	Probes, Calibrated	104 + 105
Mirrors, Micro	127	Probes, Micro	126
Mirrors, Mouth	8 + 9	Probes, Preparation depths measuring	105
Mirrors, Parallelometer	140	<b>Prof. Dr. Günay</b> Cheek retractor	48
Mirrors, Photo	10 + 11	<b>Prof. Dr. Günay</b> Gingiva / mucosa retractors	106
<b>Mltchel</b> Scalers	108	<b>Prof. Dr. Günay</b> Gingiva retractor	105
Mixing spatulas	198	<b>Prof. Dr. Günay</b> Micro raspatory	106
Modelling instruments	216	<b>Profi Design</b> Composite instruments	171
Molar pluggers	180	Props, Mouth	60
<b>Molt</b> Mouth gags	63	Prosthesis lifters, Provisional	109
<b>Molt</b> Raspatories	64 + 65	Provisional crown pliers	195
<b>Morell</b> Crown removers	196	Provisional prosthesis lifters	109
<b>Mortonson</b> Plastic filling instruments	177	<b>Ralk</b> Splinter forceps	122
<b>Mosquito</b> Clamp forceps	59	Raspatories	64 - 66
Mouth gags	63	Raspatories, Micro	106
Mouth mirror handles	5 - 7, 13	Removers, Scalpel blade	56
Mouth mirrors	8 + 9	Restorative set	237 - 239





Retraction/threads packers	184	<b>Spencer</b> Suture forceps	96
Retractors	60 + 61	Splinter forceps	122
Retractors, Cheek	47 + 48	Splinter instruments	122
Retractors, Cheek and lip	61 - 63, 133	Spreaders	125
Retractors, Gingiva	105	Stands, Bur	127 + 194
Retractors, Gingiva / mucosa	106	Sterilisation cassettes	11, 227 - 229
Retractors, Lip	62 + 133	<b>Sternberg</b> Cheek and lip retractors	62
Rongeurs	69	<b>Stieglitz</b> Splinter forceps	122
Root canal condensers	124	Surgical basis set	233 + 234
Root canal pluggers	121	Surgical implant und sinus lift set	242 - 244
Root elevators	34 - 44	Surgical suture removal set	232
<b>Routurier</b> Extracting forceps	18	Suture forceps	96
<b>Roux</b> Retractors	61	Suture material - <b>Glycolon</b>	82 + 83
Rubber dam clamps	192	Suture material - <b>Mopylen</b>	93
Rubber dam forceps	189 + 191	Suture material - <b>PGA-Resorba</b>	84 + 85
Rubber dam instruments	189 - 192	Suture material - <b>Polyester</b>	91
Rubber dam set	129 + 130, 190 + 191	Suture material - <b>Resolon</b>	88 + 89
Rulers, Measuring	127	Suture material - <b>Resotex Oral</b>	94
<b>Ruskin-Grazil</b> Rongeur	69	Suture material - <b>Silk</b>	86 + 87
<b>Ryder-Grazil</b> Needle holders	73	Suture material - <b>Supolene</b>	92
Saw blades	225	Suture material - <b>Supramid</b>	90
Saws	225	Suture material - <b>Supramid Oral</b>	94
Scalers	107 - 109, 111 - 113	Suture needles	76
<b>Scalette</b> Scalers	112 + 113	Syringes, Bone	132
Scalpel blade removers	56	Syringes, Cartridge	45 + 46
Scalpel blades	56 + 57	<b>Taylor</b> Tissue forceps	102
Scalpel handles	56 + 57	<b>Teleflex</b> Telescope crown pliers	221 + 222
Scalpels	56 + 57, 103	Telescope activating pliers	222
Scissors	49 - 55	Telescope crown pliers	220 - 222
Scissors, Gingivectomy	54	Threads/Retraction packers	184
Scissors, Gum	54 + 55	Tip protection	229
Scissors, Micro	140	Tips for probes	5
Scissors, Micro tissue	133	Tissue forceps	100 + 102
Scissors, Operating	49 - 55	Titanium forceps	131
Scissors, OP-special	54 + 55	<b>Toennis</b> Needle holders	72
Scissors, TC-inserts	53	Towel clamps	60
Scrapers, Bone	141	<b>Towner</b> Scalers	108
<b>Seldin</b> Raspatories	65	Trays, Impression	200 - 214
<b>Semken</b> Forceps	101	Tubing clamps	58 + 59
Separating spatulas	185	Tunnelling instruments	105
Set for crowns and bridges	240 + 241	Tweezers	12 - 14
Set, Diagnostic	13 + 14	Tweezers, Micro dressing	139
Set, Endodontic	128	Universal pliers	224
Set, Endodontic basis	235 + 236	<b>Vestibulum</b> Cheek and lip retractor	62 + 133
Set, Examination	230	<b>W.F. Barry</b> Root elevators	43
Set, Extraction	22 - 24	<b>Wagner</b> Operating scissors	51
Set, Micro surgical basis	245 + 246	<b>Waldsachs</b> Universal pliers	224
Set, Periodontitis examination	231	<b>Ward</b> Amalgam instruments	182
Set, Restorative	237 - 239	<b>Warwick-James</b> Root elevators	42
Set, Rubber dam	129 + 130, 190 + 191	Wax brushes	216
Set, Surgical basis	233 + 234	Wax knives	217
Set, Surgical implant und sinus lift	242 - 244	Waxing instruments	215
Set, Surgical suture removal	232	<b>Westcott</b> Amalgam instruments	183
Sharpening oil	106	<b>White</b> Plastic filling instruments	172 + 179
Sharpening stones	106	<b>White</b> Probes and explorers	2
Side nippers, Double action	224	<b>WHO</b> Calibrated probes	104 + 105
Sinus base augmentation set	135 + 136	<b>Wieder</b> Cheek retractors	47
Sinus lift curettes	142 - 145	<b>Williams</b> Calibrated probes	104
Sinus membrane curettes	137	<b>Williger</b> Raspatories	65
Sliding calipers	218 + 219	<b>Winter</b> Root elevators	43
Solingen Classics	247 - 256	Wire and clasp bending pliers	224
Spatulas, Agate	186	<b>Wiro-FILL</b> Composite instruments	162 - 170
Spatulas, Cement	185 + 186	<b>Younger-Good</b> Curettes	119
Spatulas, Micro filling	126	<b>ZA M. Beck</b> Root elevators	43
Spatulas, Mixing	198	<b>Zahle</b> Modelling instruments	216
Spatulas, Separating	185		

# SERVICE

## wird bei uns groß geschrieben!

We consider SERVICE one of the main aspects of our philosophy!

Zu unseren Leistungen gehört selbstverständlich auch ein Reparaturservice,

der unter anderem folgende Arbeiten umfaßt:

As part of our service, we offer our customers a repair service,  
including the following work processes:



1

### Diamantierung Diamond coating

Diamantierung und Nachdiamantierung von  
Zahnzangen, Pinzetten, Teleskopzangen, etc., ...  
Diamond coating and re-coating of  
extracting forceps, telescope crown pliers, etc.,...

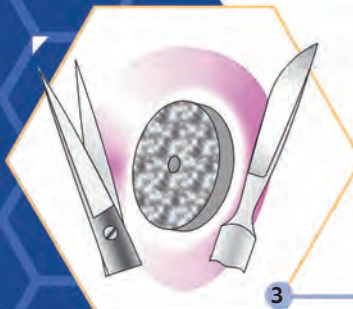

3

### Schärfen Tool sharpening

Schärfen und Nachschleifen von Scheren, Skalpell  
und sonstigen schneidenden Instrumenten  
Sharpening and regrinding of scissors, scalpels  
and other cutting instruments



5

### Oberflächenbearbeitung Surface finishing

Oberflächenbearbeitung der Instrumente, wie:  
Mattieren, Polieren, Verchromen und Vergolden  
Surface finishing of instruments, such as  
matt finishing, polishing, chrome and gold plating



7

### Sonderanfertigung Customised Instruments

Wir produzieren für Sie in Sonderanfertigung Instrumente  
nach Muster, Skizze oder ähnlichem  
For our customers, we manufacture custom-made instruments  
to specification from your samples, drawings etc.

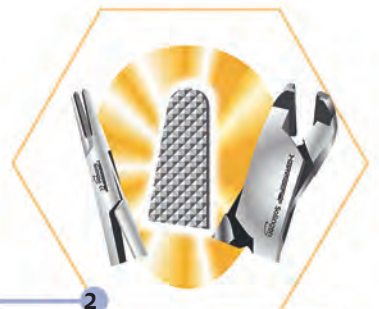

2

### TC-Einsätze TC-inserts

Erneuerung von Hartmetall-Einlagen für  
Nadelhalter und technische Zangen  
Replacement of tungsten carbide inserts for  
needle holders and technical pliers



4

### Nacharbeit Refinishing

Komplettes Nacharbeiten älterer Instrumente, wie:  
Nachpolieren, Richten, gängig machen und Entrosten  
Complete refinishing of old instruments, such as  
surface redressing, alignment, rust removal and making instruments patent

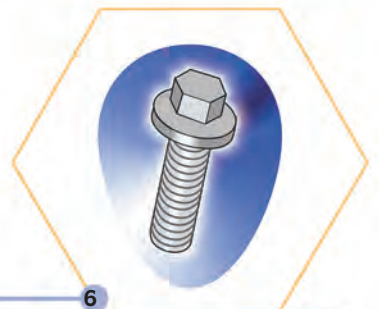

6

### Ersatz Replacement of parts

Ersatz von Schrauben, Stiften oder Nieten  
Replacement of screws, pins and rivets

© copyright: Chantal Design '92 (NL)

**In order of:** \_Karl Hammacher GmbH, Solingen  
**Ordernumber:** \_ 20211279  
**Delivery:** \_Dental catalogue 2021  
**Use:** \_for reading only  
**digital documents:** \_in Adobe Acrobat - pdf-format  
**Size:** \_original size DIN-A4  
**Coulours:** \_full-colour CMYK

---

© **Chantal Design '92**

Without the approval of Chantal Design '92 the client shall not be entitled to re-employ the design or to broader use of the design than as agreed and shall not be permitted to make (or have or allow others to make) any alterations in the provisional or final design.

Delivery; General Terms and Conditions of the Association of Dutch Designers  
(Beroepsorganisatie Nederlandse Ontwerpers - BNO)

See document: [http://www.chantaldesign.nl/BNO\\_AVW/](http://www.chantaldesign.nl/BNO_AVW/)

---

yours faithfully,

**Chantal Design '92 ( bNO )**

Chantal Hermkens  
Kastanjestraat 6,  
6014 EE Ittervoort (the Netherlands)  
Tel.: +31 (0)475-568228  
Fax: +31 (0)475-568229  
iPhone: +31 (0)6-533 535 44  
KvK-nummer: 13031381  
internet: <http://www.chantaldesign.nl>  
email: [info@chantaldesign.nl](mailto:info@chantaldesign.nl)



**Karl Hammacher GmbH**

Steinendorfer Straße 27, D 42699 Solingen (Aufderhöhe)

Postfach / P.O. Box 120209, D 42677 Solingen

Telefon 0212 / 26250-0

Telefax 0212 / 67135

E-mail : [post@hammacher.de](mailto:post@hammacher.de)

Internet : <http://www.hammacher.de>