

Dentistry Made Easier™



Formlabs Dental Ecosystem at a Glance

Validated for every dental application, our reliable, end-to-end 3D printing solutions are easy to integrate into your existing practice or lab.



FORM 4B

Blazing Speed Meets Unmatched Accuracy

Form 4B delivers unprecedented print speeds and unrivaled accuracy that matches your commitment to a perfect fit, every time.

[PAGE 4](#)

FORM 4BL

Maximum Throughput at Blazing Speed

The large-format Form 4BL 3D printer is designed for dental and orthodontic labs that require efficient, large-scale production.

[PAGE 8](#)

FORM WASH

FORM CURE

Simplified Dental Post-Processing

Unlock same-day dentistry with our automated washing and curing solutions.

[PAGE 10](#)

Dedicated Support and Education for Dental Professionals

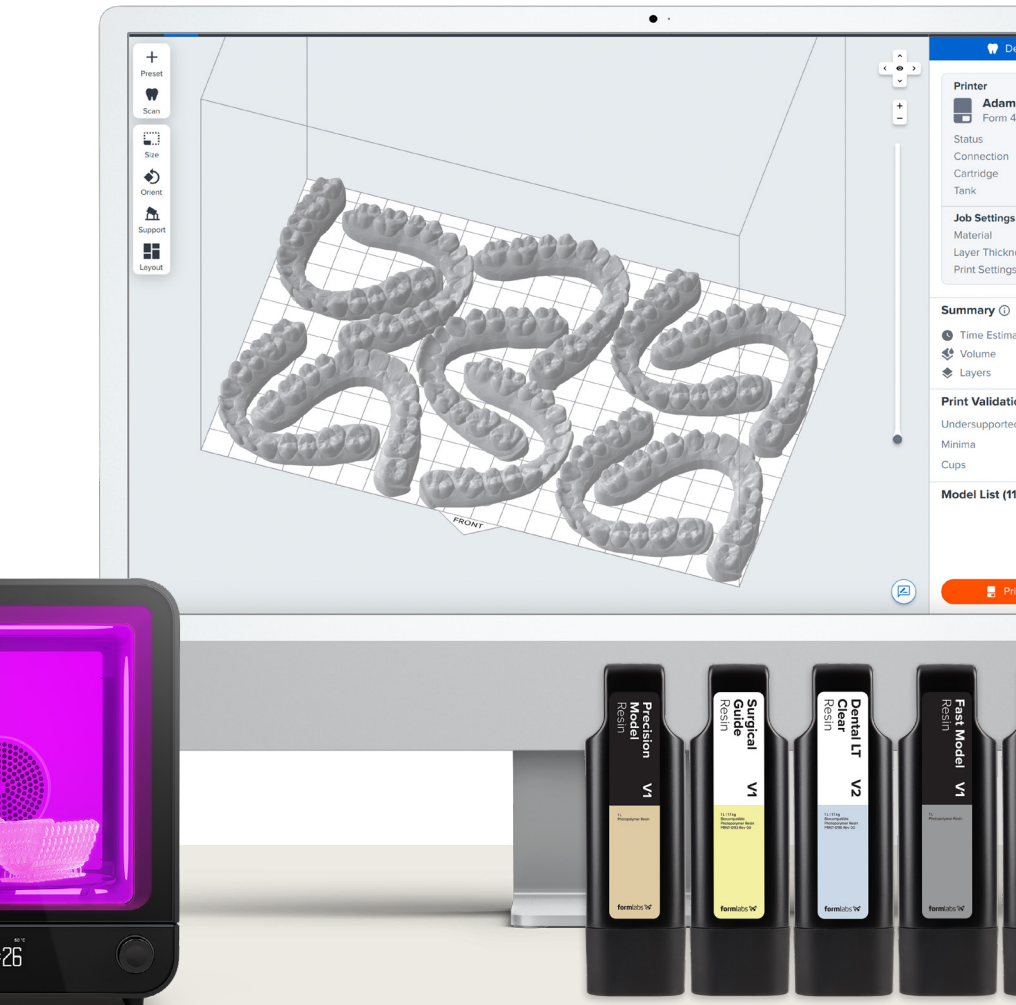

[Dental Service Plan \(DSP\)](#)

Premium Dental 3D Printing Support

Get started immediately with personalized training and priority access to our experts.

[PAGE 12](#)

[Software](#)

The Most Streamlined Solutions for One-Click Printing

From IOS integration to remote print monitoring, our software empowers you to press print from anywhere.

[PAGE 12](#)

[Specialized Dental Resins](#)

Fully Validated Resins for Every Dental Application and Open Material Mode

Grow your business with our advanced range of proprietary resins including biocompatible options and print any resin with Open Material Mode.

[PAGE 7](#)

[Formlabs Dental Academy](#)

Your Learning Hub for Digital Dentistry

Master digital dentistry with our in-depth library of tutorials and guides for every workflow.

[PAGE 12](#)



FORM 4B

Blazing Speed Meets Unmatched Accuracy

Powered by our Low-Force Display™ (LFD) Print Engine, Form 4B delivers unprecedented speed, while maintaining superior dimensional accuracy and surface finish across 15+ validated dental applications.

- FAST** 11 models* in nine minutes

- OPEN** 15+ Formlabs resins and Open Material Mode

- INTUITIVE** Anyone can learn in 15 minutes

- ACCURATE** 95% of surface within $\pm 50 \mu\text{m}$

- RELIABLE** 99% print success

- 1 LEDs
- 2 Collimating Lenses
- 3 Light Processing Unit 4
- 4 Release Texture
- 5 Flexible Film Resin Tank
- 6 Resin
- 7 Supports
- 8 Build Platform
- 9 Printed Part
- 10 Six Intelligent Control Systems
- 11 High-Speed Automatic Resin Handling

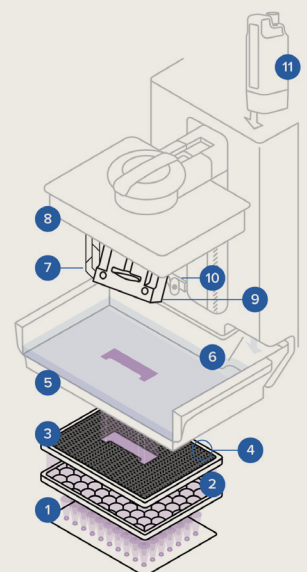



Industry-Leading Print Quality

UNRIVALED ACCURACY FOR A PERFECT FIT

Deliver dental parts with industry-leading surface accuracy of over 95% of data points within $\pm 50 \mu\text{m}$ of the original CAD data, and consistency across the entire build platform.



An Unmatched Seamless Workflow

AUTOMATED, MESS-FREE PRINTING

Discover the world's most effortless 3D printing workflow. Instantly remove parts without tools with Flex Build Platform, seamlessly switch between resins with Intelligent Material Handling, and keep your workspace spotless with automated, spill-proof resin dispensing.



Advanced 3D Printing Materials and Open Material Mode

FULLY VALIDATED WORKFLOWS FOR 15+ DENTAL APPLICATIONS

Unlock the widest range of validated dental materials in the industry – including an advanced range of biocompatible options, manufactured in our state-of-the-art facilities to the highest ISO standards – and other certified third-party resins. Formlabs Dental 3D printers also offer the flexibility to print any 405 nm resin using Open Material Mode.



Unprecedented Print Speeds

PRINT 11 MODELS* IN NINE MINUTES

Form 4B is faster than ever, without compromising on accuracy. Print jobs are completed up to four times faster than previous generations of Form Series 3D printers, regardless of whether you're printing one part or a full build platform.

*Models printed using Fast Model Resin at $160 \mu\text{m}$



1

FORCE SENSOR

Optimizes print speed across materials and geometries

2

CAMERA

Enables remote monitoring and troubleshooting

3

RESIN TEMPERATURE SENSOR

Adjusts temperature for optimal print results

4

RESIN LEVEL SENSOR

Automatically triggers tank refill

5

MIXER DEBRIS SENSING

Checks for debris to reduce print failures

FORM 4B TECH SPECS

TECHNOLOGY	Masked Stereolithography (MSLA)
PRINT ENGINE	Low Force Display™ (LFD)
BUILD VOLUME (W x D x H)	20.0 × 12.5 × 21.0 cm 7.9 × 4.9 × 8.3 in
LAYER THICKNESS	25-200 µm
XY RESOLUTION	50 µm
AVERAGE PRINT SPEED	40 mm/h
MAXIMUM PRINT SPEED	100 mm/h
RESIN TANK LIFETIME	75,000+ layers with any Formlabs material
PRINTER WEIGHT	18.3 kg 40.4 lb
PRINTER DIMENSIONS	39.8 × 36.7 × 55.4 cm 15.7 × 14.5 × 21.9 in
WARRANTY AND SERVICE	One-year warranty included Paid service and extended warranty options available
SOFTWARE COMPATIBILITY	Windows 10, 64-bit (version 1809) and up Mac OS X 10.15 and up
FILE TYPES ACCEPTED	STL, OBJ, 3MF, and more

High-Accuracy 3D Printing Materials

Validated for Orthodontic and Restorative Applications

Orthodontic Applications

Models for Diagnostics and Thermoforming Appliances

Models in Record Time for Diagnosis or Aligner Production



Indirect Bonding Trays

Accurate Bonding That's Easier to Plan and Use



Occlusal Splints and Guards

For Long-Lasting Rigid and Flexible Appliances



Open Material Mode

Maximize the potential of your Formlabs 3D printer. Print any third-party 405 nm photopolymer resin with Open Material Mode including Lucitone Digital Print Denture™ System.* Create custom print settings for tailored print performance using PreForm's Print Settings Editor.

*More third-party resin manufacturers are in the process of validating their resins for use with Formlabs SLA printers through Open Material Mode.

Restorative Applications

Wax-Up Models

Your Digital Design With a Smoother Surface Finish



Restorative Models

Soft and Rigid Components for Better Prosthetic Planning



Temporary and Permanent Restorations

State-of-the-Art Ceramic-Filled Restorations



Direct Composite Restoration Guides

Perfectly Replicate Digital Designs With Faster Workflows

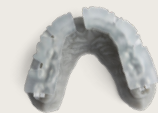

Custom Impression Trays

Directly Printed for a Quicker Turnaround



Surgical Guides

For Highly Accurate and Predictable Implant Placement



Temporary All-on-X Appliances

For Reliable and Accurate Temporary Full-Arch Implant-Supported Restorations



Digital Dentures

Expanding Access to High-Quality Dentures in Custom Shades



Patterns for Casting and Pressing

Optimize Your Analog Workflow With Digital Accuracy





FORM

4BL

**Speed That Scales.
A New Era of Dental
Manufacturing.**

**HIGH
THROUGHPUT**

Fit up to 32 flat or 75 vertical dental models in one print

BLAZING FAST

Print 32 models in 14 minutes*

ACCURATE

Repeatable accuracy you can count on

VERSATILE

Effortlessly create parts for high-volume dental applications

**MAXIMUM
UPTIME**

Large format 3D printing you can depend on

STREAMLINED

Easy, efficient operation optimized for large-scale production

*Estimates based on orthodontic models printed with Fast Model Resin at 160 μ m

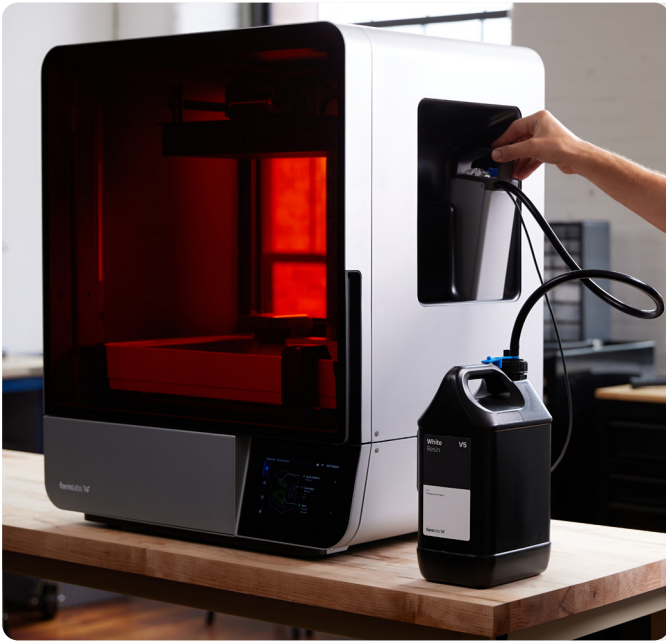

Resin Pumping System

RESIN PUMP AND 5 L RESIN CONTAINER FOR FORMLABS SLA 3D PRINTERS

Reduce Costs

Reduce total costs with bulk resin pricing – now available at 5 L volumes.

Improve Operational Efficiency

Print 5x longer and minimize printer interactions with less frequent cartridge changes.

Reduce Waste

Reduce packaging waste by 86%.

FORM 4BL TECH SPECS

TECHNOLOGY	Masked Stereolithography (MSLA)
PRINT ENGINE	Low Force Display™ (LFD)
BUILD VOLUME (W x D x H)	35.3 x 19.6 x 35.0 cm 13.9 x 7.7 x 13.8 in
LAYER THICKNESS	25-200 µm
XY RESOLUTION	46 µm
AVERAGE PRINT SPEED	24 mm/h
MAXIMUM PRINT SPEED	80 mm/h
RESIN TANK LIFETIME	75,000+ layers with any Formlabs material
PRINTER WEIGHT	58.5 kg 129 lb
PRINTER DIMENSIONS	66.4 x 52.8 x 79.4 cm 26.1 x 20.8 x 31.3 in
WARRANTY AND SERVICE	One-year warranty included Paid service and extended warranty options available
SOFTWARE COMPATIBILITY	Windows 10, 64-bit (version 1809) and up Mac OS X 10.15 and up
FILE TYPES ACCEPTED	STL, OBJ, 3MF, and more

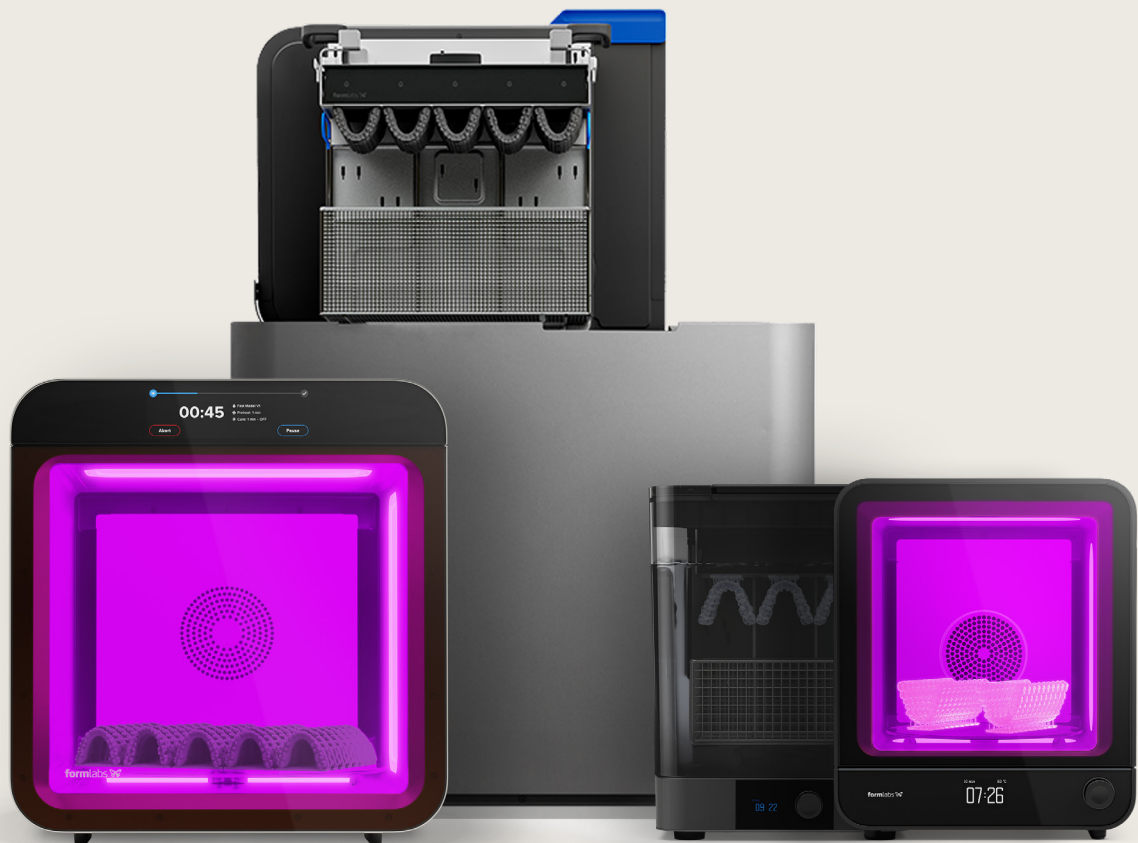

Dental Part Post- Processing

Achieving peak quality of your dental prints requires a washing and curing process. Say goodbye to complex manual procedures with our automated post-processing solutions that complete the biocompatible workflow. With pre-programmed settings for each material, you can bring parts to consumer-grade quality with the touch of a button.

Set It and Forget It: The **Form 4B** Post-Processing Workflow

STEP 1 **Print**

Set up prints in just a few clicks with our pre-programmed settings.

STEP 2 **Wash**

Transfer the Build Platform to Form Wash V2 or Form Wash L V2 for an automated deep clean.

STEP 3 **Cure**

Transfer clean parts to Form Cure V2 or Form Cure L V2 to bring them to their peak mechanical properties.



Form Wash V2

GLOVE-FREE CLEANING

Form Wash V2 has 3x improved agitation, pre-programmed settings, and adjustable build platform mounts for thorough washing and streamlined workflows.

DIMENSIONS: 31.5 x 29.3 x 40.5 cm | 12.4 x 11.5 x 15.9 in
HEIGHT WHEN OPEN: 71.4 cm | 28.1 in

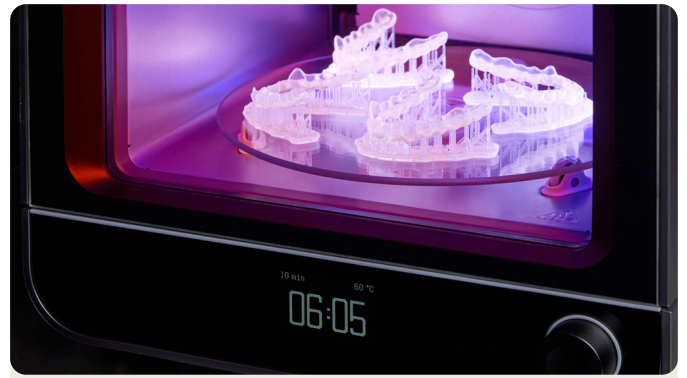

Form Cure V2

DENTAL PART CURING IN MINUTES

Cure any dental part in just one to 10 minutes. Pre-programmed, validated settings ensure safe and precise curing of biocompatible resins without guesswork. Cure up to 15 models per minute with the spacious turntable.

DIMENSIONS: 33.7 x 40.4 x 37.2 cm | 13.3 x 14.0 x 15.9 in

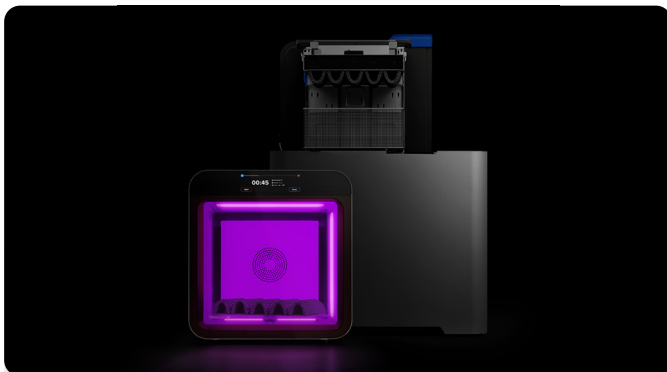

Form Wash L V2, Form Cure L V2

LARGE-FORMAT SOLUTIONS FOR HIGH-VOLUME PRODUCTION

Form Wash L V2 and Form Cure L V2 are capable of post-processing one Form 4BL or two Form 4B batches at once.

Form Wash L V2

DIMENSIONS: 78.0 x 46.0 x 67.0 cm | 30.7 x 18.1 x 26.4 in
HEIGHT WHEN OPEN: 71.4 cm | 28.1 in

Form Cure L V2

DIMENSIONS: 50.7 x 54.3 x 54.5 cm | 20.0 x 21.4 x 21.5 in



Formlabs Resin Washing Solution

SAFE AND COST-EFFECTIVE

This lower-odor washing solution is non-flammable per GHS classification, cleans parts* as well as isopropyl alcohol (IPA), and has twice the longevity for a lower cost per wash.

*Formlabs Resin Washing Solution is compatible with most non-biocompatible Formlabs Resins

Complete Dental 3D Printing Software Solutions

Our comprehensive suite of dental software tools is designed to help you save time, reduce costs, and enhance the overall efficiency of your practice or lab.

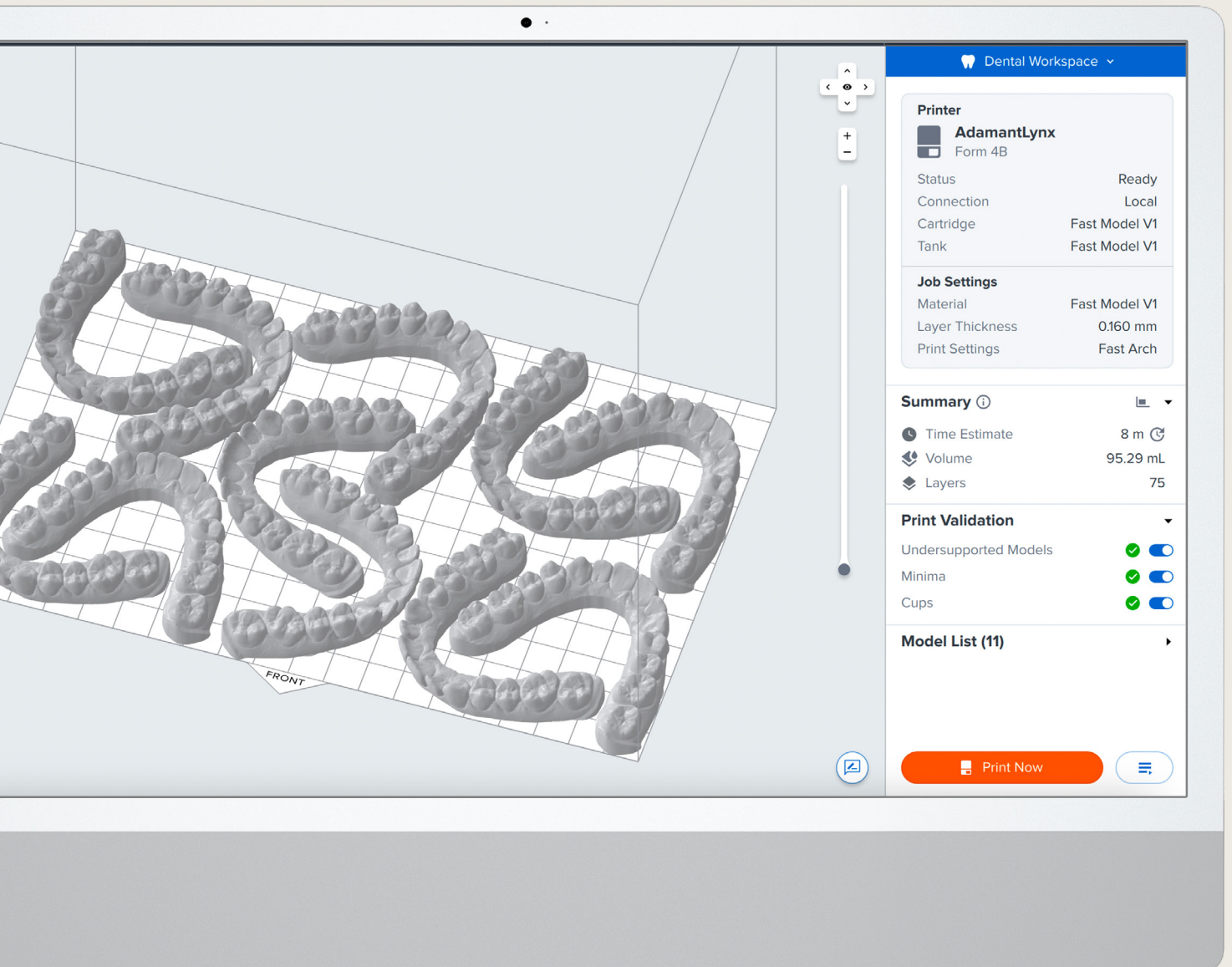

PreForm Dental

CLICK LESS, DO MORE WITH THE NEW STANDARD IN DENTAL PRINT PREPARATION SOFTWARE

Our free dental print preparation software is designed to help your team set up prints more effortlessly and efficiently than ever before. Prepare parts for printing in just a few clicks and access your printers remotely from the cloud with advanced software tools.

SCAN TO MODEL

Compatible with every intraoral scanner on the market. Seamlessly bridge the gap between scanning and printing by converting patient scans to printable solid or hollow models in less than 10 seconds.

EFFORTLESS PRINT PREPARATION

Set up your models automatically with one-click print preparation, or create custom presets according to your needs.

ADVANCED FEATURES POWERING EFFICIENCY

Optimize resin use and print time by hollowing models. Add drain holes to prevent trapped resin and eliminate cups. Customize parts with labels for easy traceability.

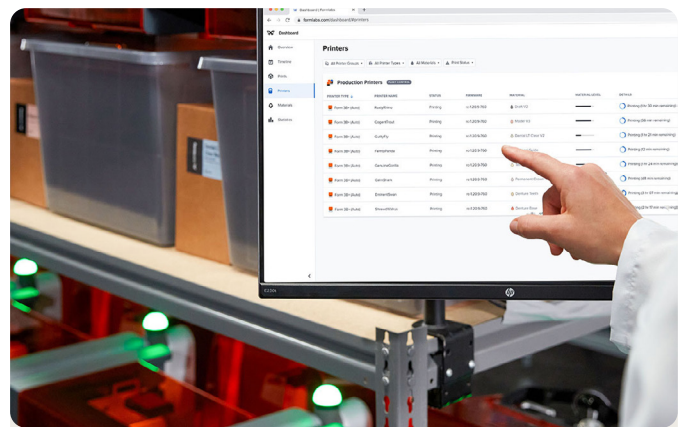
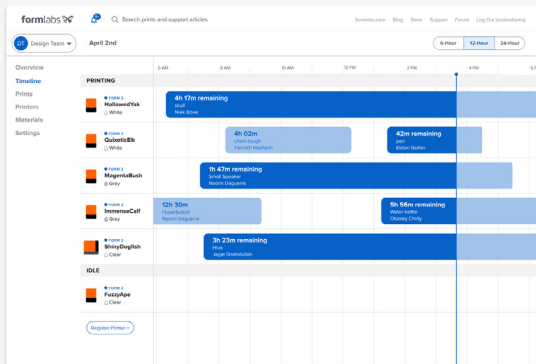

Dashboard

MAXIMIZE OPERATIONAL EFFICIENCY WITH OUR FREE PRINTER MANAGEMENT PORTAL

Manage your dental printing operations from anywhere with our free online printer management portal that provides insights that empower you to run your business with maximum efficiency.

Printer and Consumables Tracking

Track real-time data on printing, material, and employee usage.

Remote 3D Printing

Start print jobs from anywhere, anytime for back-to-back throughput.

Printer Groups

Manage multiple 3D printers across different purposes or locations.

Advanced Free Features

MULTI-PRINTER MANAGEMENT FOR PREFORM DENTAL AND DASHBOARD

Automate and optimize print jobs across your whole fleet by activating advanced optimization features within PreForm and Dashboard.

Automated Printer Assignment

Group Queues automatically assigns print jobs to the next available printer.

Consolidated Insights & Advanced Settings

Take full control with live consolidated updates and advanced user settings.

Bulk Firmware Updates

Update your printer fleet all at once with bulk firmware updates.



Dedicated Support and Education for Dental Professionals

Enjoy a seamless transition to digital dentistry with our community of experts and library of learning resources.

Formlabs Dental Service Plan (DSP)

PREMIUM DENTAL 3D PRINTING SUPPORT

Get started immediately and unlock the full potential of your Formlabs 3D printer with our dental service experts by your side. Designed by dental professionals, for dental professionals, our comprehensive Dental Service Plan includes priority access to the best support in the industry, personalized onboarding and training, fast maintenance, and more.

- Priority phone and email support from certified dental experts
- Live Q&A session with a certified dental expert to ask questions about your specific workflow
- Hot Swaps: if troubleshooting doesn't get you back to printing, we'll expedite a replacement
- Extended warranty converge up to three years

Formlabs Dental Academy

YOUR LEARNING HUB FOR DIGITAL DENTISTRY

Learn how to perform every supported digital dentistry workflow with Formlabs' comprehensive library of step-by-step guides, clinical papers, and trainings covering over one hundred topics.

- Educational library covering multiple dental topics
- Step-by-step guides for every supported dental application
- 24/7 on-demand learning options in multiple languages
- Clinically authored case studies and white papers
- In-person and virtual courses by Formlabs and Trusted Educational Centers
- Exclusive access to Formlabs product offers

Maximize Your Time, Money, and Throughput With Formlabs Dental 3D Printing Solutions

"We can actually do same-visit printing, where we can go from a scan to a printed model and fabricate an appliance very easily within 10 minutes so we have it before a patient leaves."

Dr. Christopher Baer DMD
Baer Dental

"It's a very easy set-up and very fast! From a user standpoint, meaning someone that is not trained to 3D print, this is a really easy set-up. It's so easy to use and intuitive"

Dr. Lisa Alvetro DDS
Orthodontist & Owner
Alvetro Orthodontics

"With the Form 4BL's build platform, which is three times larger, we can now produce three times more models with just one user intervention."

Stephan Kreimer MDT
Kreimer Dentallabor GmbH & Co. KG